

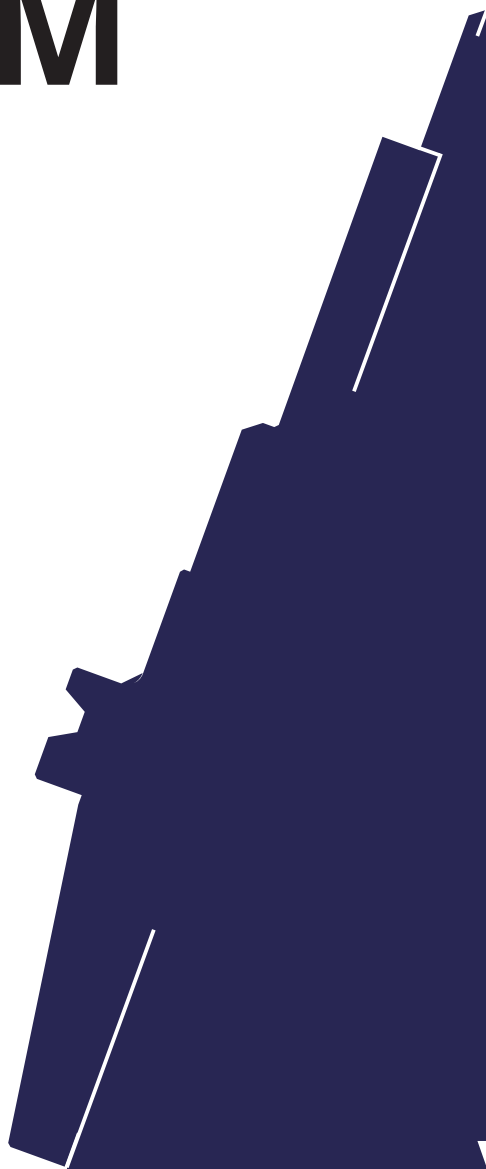

TOOLING SYSTEM

General Catalog

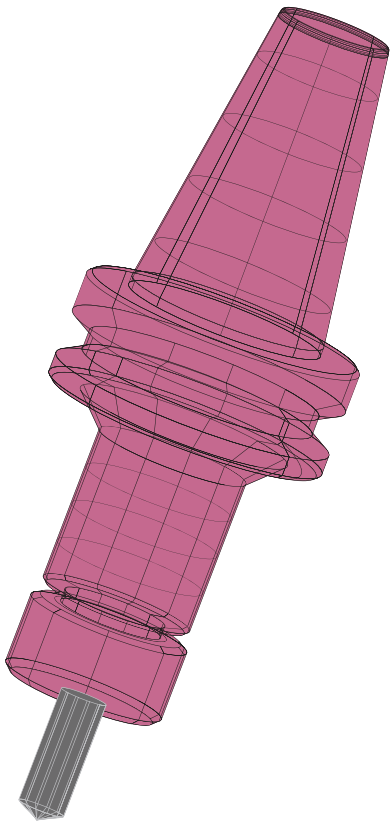

MST corporation

Vol. 4 
1901

Individuality and creation

Since its inauguration in 1937, MST has been developing new products with forward-looking creativity. We have a basic philosophy of "Personality and Creation", and we pursue of originality and try to improve brand value as we strive to meet the needs of our customers.



■ Fusing humans and machines

By fusing the automated machining processes and by-hand processes at a high level, we are aiming to produce even higher quality products.



A new challenge

By making the most of our accumulated knowledge and experience, we are developing new processing technologies and providing new service.

■ Graphite Machining

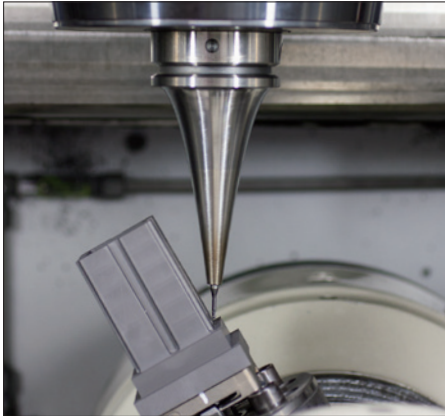

Thailand factory

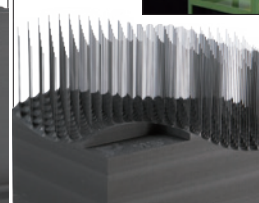

We make graphite electrodes to your specifications. State-of-the-art facilities and production systems offer our customers quick delivery and large-volume order fulfillment.

■ Micromachining

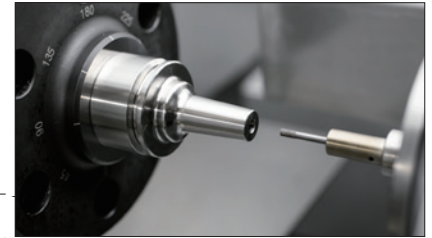
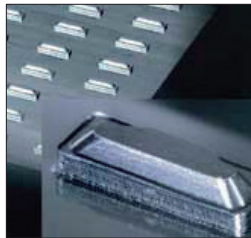
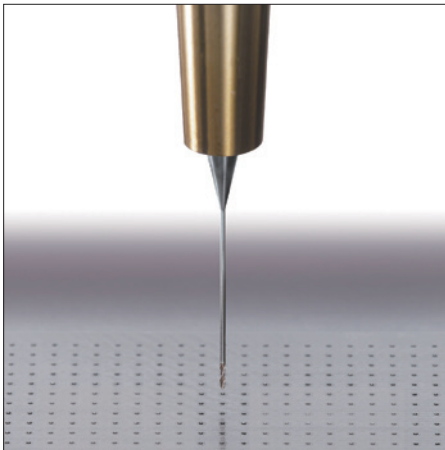

Slimline UNO finishing process

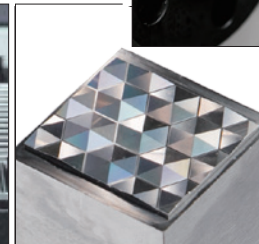

We meet our customers' needs using micron-precision process technology which have been cultivated throughout history.



RELIABLE TOOLING

MST's tooling is subject to its own MST's 4 accuracy standards: taper contact, roundness, surface roughness and heat treatment. These are more precise than JIS or MAS standards. We provide trustworthy products under strict quality control.

● MST's 4 accuracy standards.

1 Taper contact	%	90
2 Roundness	μm	0.8
3 Surface roughness (Rmax)	μm	0.6
4 Heat treatment	Material	SCM415
	Carburized depth	mm 0.8 ~ 1.0
	Hardness	HRC 55° ± 2°

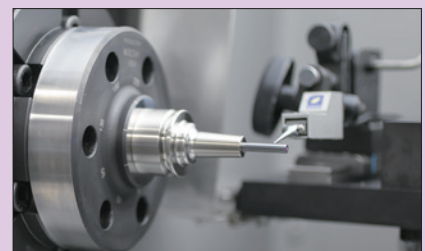
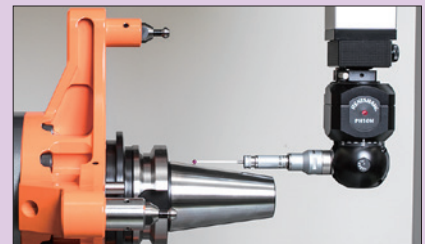

SHRINK-FIT HOLDER SLIMLINE

SLIMLINE contributes to the improvement of machining accuracy and cost reduction in 5-axis machining, micro-precision machining, and heavy duty applications.

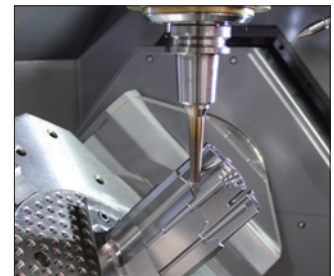
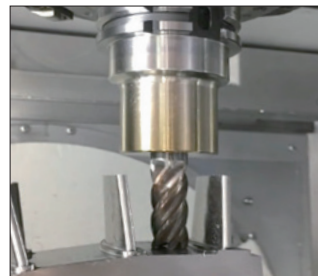
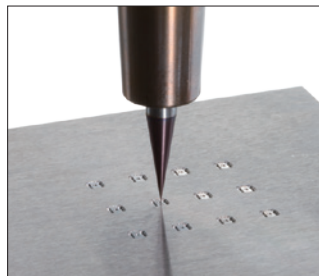
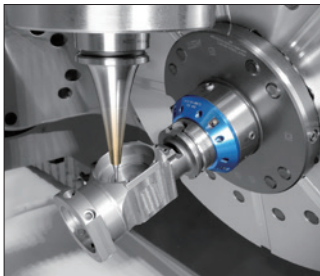

The SLIMLINE shrink-fit holder provides the perfect solution.

A simple chucking mechanism without any parts.

Stable gripping force.
No gaps.
No parts.
A cutter does not fall off even if vibrated.



Super-slim shape

Allows the holder to enter a workpiece. Can be used with a standard tool.

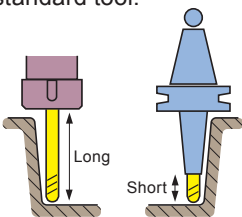





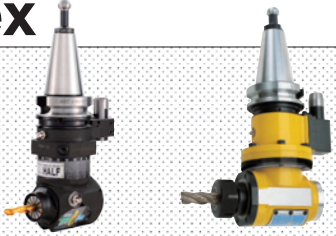
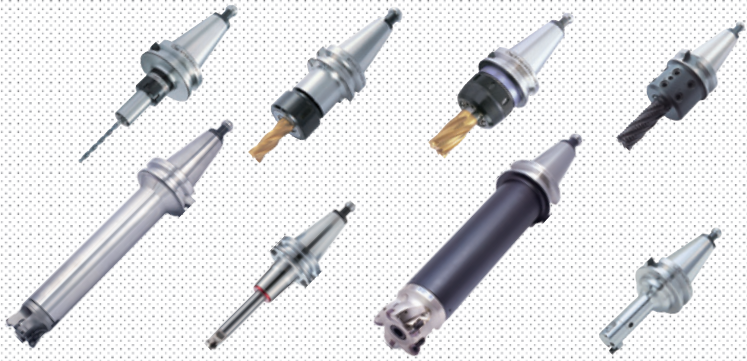

High accuracy

Twice the tool life.
Slim tools are also no problem.
Anyone can use them...

<p>✗ Short cutter life.</p>	<p>✗ Small tools break soon!</p>
<p>✗ Cutter run-out adjustment is troublesome!</p>	<p>✗ The end mill slips or falls off!</p> <p>The workpiece is ruined.</p>
<p>✗ The applicable tools are special!</p>	<p>✗ The coolant leaks.</p>

Master Index

ANGLE HEAD		HALF	6		
		STANDARD type	14		
M/C Tool		DETa-1 Collet Holder	22		
		COLLET HOLDER	32		
		HI-ART MILLING CHUCK	40		
		SUMMIT	43		
		FMH RIGID type	46		
		RED SCREW arbor	48		
		Cutter arbor with spindle-through coolant	53		
		MICRO HEAD	55		
		Retention knob	64		
		HSK - T Tooling Systems for Turning Mill		Set screw holders for Round shank	69
Insert holders for Square-shank	70				
General Purpose Tool		Universal Facing Boring Head	73		
		SMART GRIP	75		
JIG		GOO checker	82		
		Centering bar	84		
Measuring Equipment		6S DESK	86		
		CLEAN BOX	88		
		TEST BAR CHECKMATE	90		
		TOOL CAP	91		
		Tool set up stand	94		
		PALETTE	96		
		ENDMILL HOUSE	97		
		TOOL HOLDER STORING CABINET	98		
		Maintenance Tool		MIDDLE VISE	99
				Wire Cut Unit	101
Wire EDM fixture		PARTS	103		
		ANGLE HEAD HALF PARTS LIST	105		
		Technical support	114		
		Instructions for use	115		
Technical Information		For high-speed spindle rotation	118		
		HSK SHANK	119		
		Technical data	120		
		OVERSEAS NETWORK	128		

For High-accuracy, and High-efficiency machining

5 Points



End-mill



Small size drill

1 The shortest

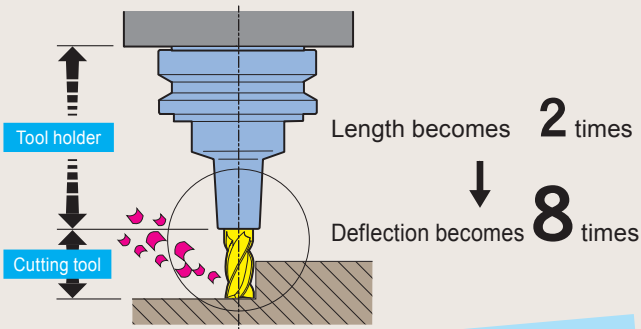

Use shrink-fit holders with a slim-tip!

As short as possible
Deflection amount is proportional to projection length³.

2 Selection

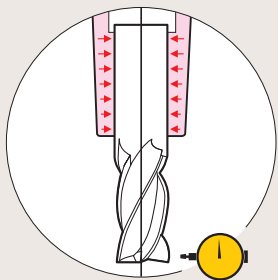

Stronger than collet holders
Clamping force **3** times
Run-out accuracy within **3** microns

Use shrink-fit holders with strong clamping force and high accuracy!

Choose a tool holder that can clamp a cutting tool securely and with high accuracy.

3 Quality

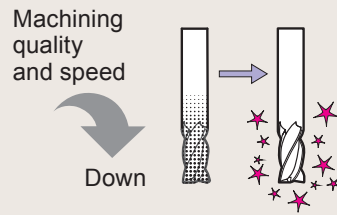

Replace!

Do not use worn cutting tools.

4 Cleanliness

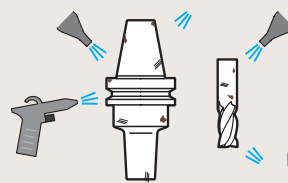

Cutting chips and oil are **your main enemies.**

Use a tool holder washing machine,

CLEAN BOX!

Clean your tool holders and cutting tools.

5 Accuracy

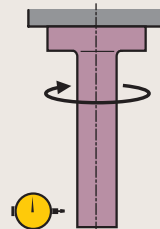

Check

the spindle condition

Use a test bar for dedicated machine spindle maintenance,

CHECKMATE!

Machine spindle run-out accuracy should be within 10 microns (.0004").

The shrink fit holder with the slim design, superior gripping force and run-out accuracy.

SHRINK-FIT HOLDER
SLIMLINE



If you would like more detailed information, please contact MST and ask for a SLIMLINE catalog.

Thickness **1.5mm (.06")**
3 μm (.0001")

Tool holder washing machine



CLEAN BOX

Washes tool holders, collets, nuts and cutting tools thoroughly to maintain their high accuracy

➔ P.88

TEST BAR

CHECKMATE

Ideal for easy machine spindle run-out accuracy checks.

➔ P.90

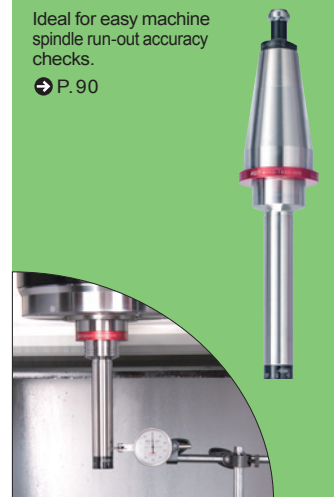



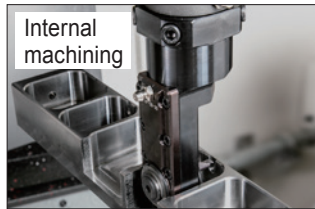
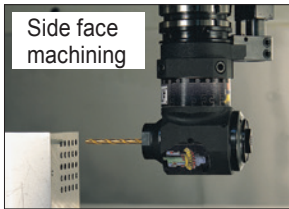

ANGLE HEAD

You can carry out 5-surface machining, such as side face and inside surface, without needing to change the positioning of the work-piece.







Voluminous variety

■ New concept Angle head **HALF** for drilling and tapping applications **Affordable • Lightweight • Shorte delivery!**

Type	Angle	MODEL	Application	Chucking range (φD)		MAX. (min ⁻¹) [Main spindle : Angle shaft]	ATC	 Kg	
90° type ↪ P. 8  mini type ↪ P. 10	90°	HFC6	Drill Endmill	φ3, 4, 6	FCS6	5600:5000 [1 : 0.88]	○	1.8	
		HFD 7		φ1 ~ 7	D 7	6000:6000 [1(CCW):1(CW)]			
		HFD12		φ2.5 ~ 13	D12	4000:4000 [1(CCW):1(CW)]			
		HFA10	Tap	φ2.4 ~ 10	C10	6000:6000 [1(CCW):1(CW)]		1.8	
		HFA20		φ5.8 ~ 20	C20	6000:5000 [1(CCW):0.83(CW)]			4.4
		HFC6		M4, 5, 6	FCS6	5600:5000 [1 : 0.88]			1.8
		HFT 4	Tap	M2 ~ 8	TA4	6000:6000 [1(CCW):1(CW)]		2.3	
		HFT 6		M3 ~ 12	TA6	4000:4000 [1(CCW):1(CW)]		2.9	
		HFT12		M3 ~ 16	TA6/12	6000:5000 [1(CCW):0.83(CW)]		4.4	
UNIVERSAL type (Free setting of cutting directions) ↪ P. 11 	0° ∩ 120°	HUD 7	Drill Endmill	φ1 ~ 7	D 7	6250:3000(BT30:7200:4000) [1(CCW):0.48(CW)] [BT30:1(CCW):0.56(CW)]	○	1.8	
		HUA10		φ2.4 ~ 10	C10	6300:3000 [1(CW):0.48(CW)]		3.9	
		HUA20		φ5.8 ~ 20	C20			4.8	
		HUT 4	Tap	M2 ~ 8	TA4	6250:3000 (BT30:7200:4000) [1(CCW):0.48(CW)] [BT30:1(CCW):0.56(CW)]		3.8	
		HUT 6		M3 ~ 12	TA6	6300:4000 [1(CW):0.48(CW)]		4.8	

■ High-rigidity **STANDARD** type

(※Use the BT30 tooling system with the Quick Change system.)

MODULAR type (Recombination type) ↪ P. 15 	90°	AHB 5	Drill Endmill	φ0.5 ~ 5	ER8	6000:6000 [1(CCW):1(CW)]	○	5.5
		AHB 7		φ0.5 ~ 7	ESX12			5.3
		AHB10		φ2.4 ~ 10	C10			6.2
SOLID type ↪ P. 16 	90°	AHA20	Drill Endmill	φ5.8 ~ 20	C20	3000:2430 [1(CCW):0.81(CW)]	○	7.3
		AHA25		φ5.8 ~ 25	C25	2500:2400 [1(CCW):0.96(CW)]		13.6
		AHD30		BT30 [※]	BT30	14.7		
FLANGE type (Mounting directly on machine spindle) ↪ P. 17 	90°	AHA20	Drill Endmill	φ5.8 ~ 20	C20	3000:2430 [1(CCW):0.81(CW)]	×	18.0
		AHA25		φ5.8 ~ 25	C25	2500:2400 [1(CCW):0.96(CW)]		18.5
		AHD30		BT30 [※]	BT30	19.6		
UNIVERSAL type (Free setting of cutting directions) ↪ P. 18 	0°	AHU10	Drill Endmill	φ2.4 ~ 10	C10	3000:4500 [1(CW):1.5(CW)]	○	9.6
	90°	AHU20		φ5.8 ~ 20	C20	3000:3000 [1(CW):1(CW)]		15.8

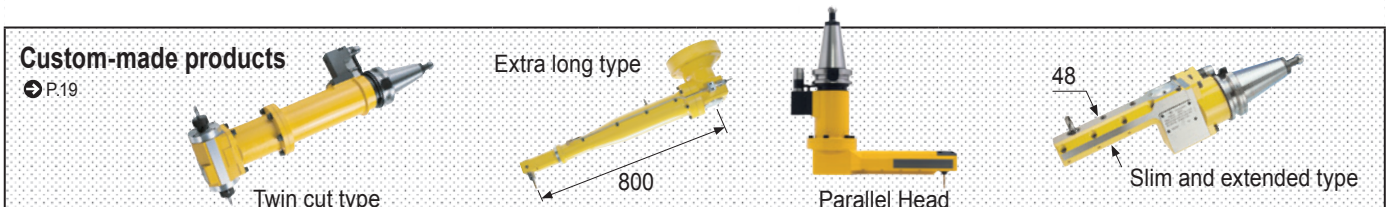

ANGLE HEAD HALF

PAT.

- Affordable**
2,300USD~
- Speedy**
Shorter delivery
- Lightweight**
1.8kg~
- Compact**
φ36~
- Repair it yourself**

Drilling and tapping account for 80% of angle head operation.

The Angle Head HALF was redesigned to achieve the necessary rigidity and accuracy, it allows;

- AFFORDABLE** (Price : 1/2)
- QUICK DELIVERY** (Lead Time : 1/2)
- LIGHTWEIGHT** (Weight : 1/2)

NEW CONCEPT



M/C Tool

HSK-T Tooling Systems for Turning Mill

General Purpose Tool

JIG

Measuring Equipment

Maintenance Tool

Wire EDM fixture

Technical Information

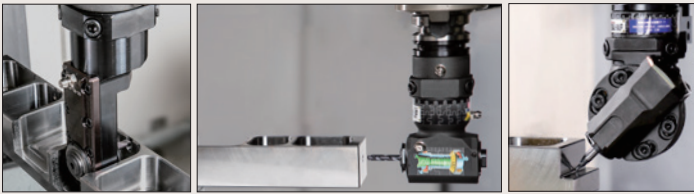

90° type

BT30/40/50
HSK-A63
DIN40/50,
CAT.40/50

HFD/HFA
φ1~20mm

HFT
M2~16

mini type

Extra-compact head

BT30/40/50
DIN40/50
CAT.40/50

HFCS
φ3,4,6mm
M4,5,6

15.5 31.5 φ36

UNIVERSAL type

Angle can be set arbitrarily

BT30/40/50
DIN40/50
CAT.40/50

HUD/HUA
φ1~20mm

HUT
M2~12

120° 120°

Compact design

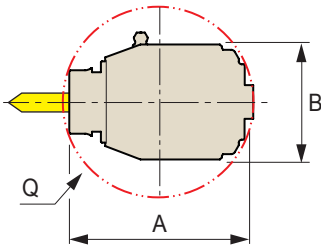

Type	MODEL	Q	A	B
90° type	HFD 7	72	68	38
	HFD12	98	93	58
	HFT 4	75	73	38
	HFT 6	97	92	58
	HFA10	90	87	38
	HFA20	119	111	64
	HFT12	97	96	64
mini type	HFCS6	36	31.5	31

Auto Tool Changer (A.T.C) is available on BT30 machine.



BT30
1.8kg

Easy installation

The positioning pin allows an in-use positioning block to be used is now a standard feature. Can be used with a variety of machining centers.

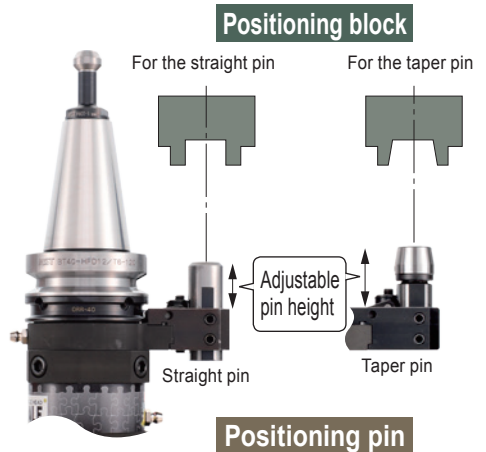

Easy disassembly and assembly

- The number of parts (22 pcs.) is half that of conventional angle heads.
- No need for fine matching and adjustment.
- Makes use of commercial items such as bearings. Affordable and readily available.
- An informative video and an instruction manual for disassembly and reassembly are provided.



Running cost is reduced by 90% as a result of reduced repair costs and machine down time.

Easy to reassemble

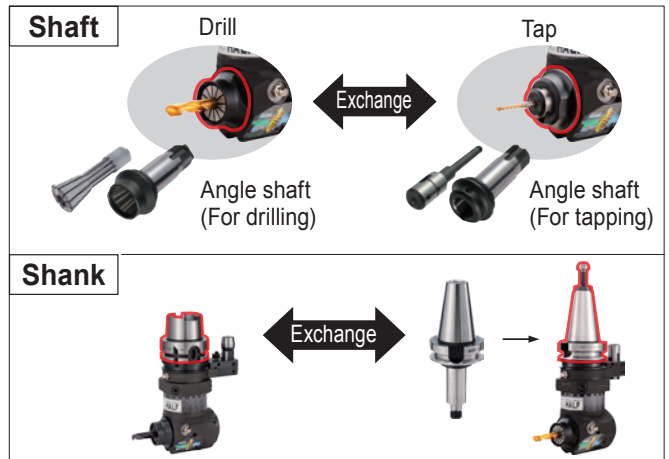

Positioning block and positioning pin

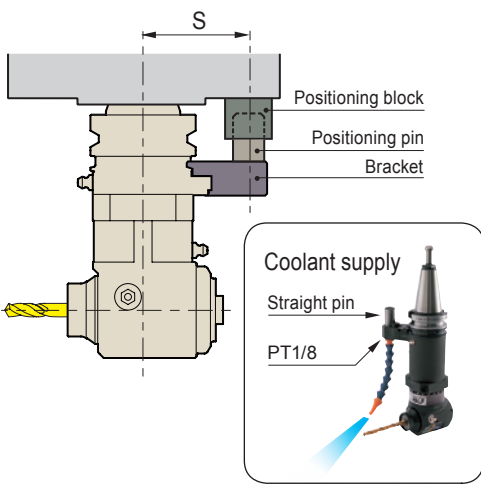

Positioning block

Positioning pin

Bracket

- S dimension can be changed by reassembling the bracket.
- The positioning pin can be easily adjusted in length and replaced.

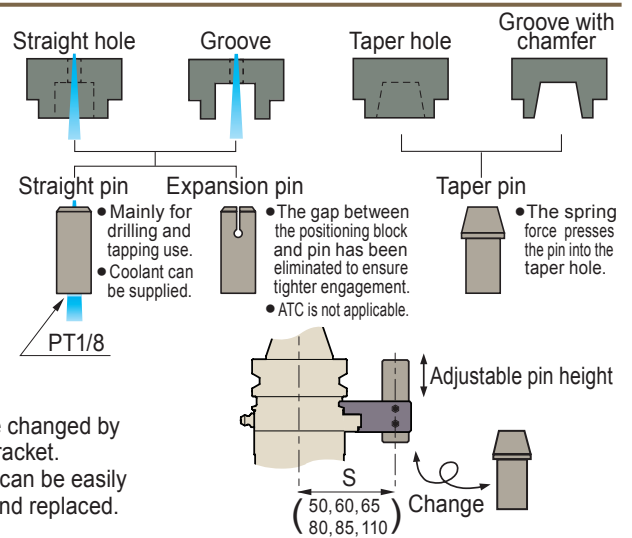

Semi-finished positioning block

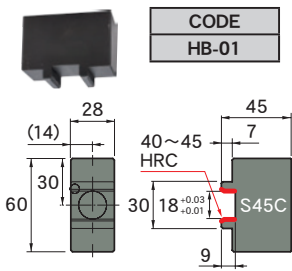

- Note**
- Please confirm with the machine tool manufacturer about the dimensions of the positioning block.
 - We have a semi-finished positioning block with a taper hole available. (→P.19)

Positioning block for machines

• FANUC ROBODRILL α-DiB series



• MAZAK SUPER VELOCITY CENTER 2000L/120-II 2000L/200-II



• Available from Yamazaki Mazak Corp.

• BROTHER SPEEDIO Compact machining center



Caution

- TC-S2A※ (Tapping center), The user needs to confirm whether the positioning block can be mounted on the machine (spindle surface) or not. Please contact us.
- TC-R2B※ (Tapping center) machining area is limited to some extent due to interference between the positioning block and the internal part cover of the machine. For more information, please contact us.

A product code example when ordering Angle Head HALF.

- FANUC BT30-HFD7-122-S65
- BROTHER BT30-HFD7L-120-S50C

CODE	NOTE
ABF213	S300X1 /X2, S500X1 /X2, S700X1 /X2
ABF259	S1000X1
ABF176	TC-S2, S2A※, S2B, S2C, S2D, R2B※

Kit Package

- Learning Kit to understand gear and bearing mechanism.
- There are only 22 parts and anyone can assemble them in about 10 min.
- Spare/consumable parts and assembly tools are included.



Contents of kit	CODE	
	BT40-HF12-LK	BT50-HF12-LK
Complete unit	BT40-HFD12-180-S65 (1pc.)	BT50-HFD12-195-S80 (1pc.)
Angle shaft (For tapping)	FR-T6 (1pc.)	
Tap sleeve	TA6-3, 4, 5, 6, 8 (each 1pc.)	
DETa-1 Collet	D12-4, 6, 8, 10, 12, 13 (each 1pc.)	
Positioning pin	HP-50T(1pc.)	HP-62T(1pc.)
Spare bearing	7005ADB (1set), 6805 (1pc.), 51106 (1pc.)	

HALF 90° type

Drill · Endmill

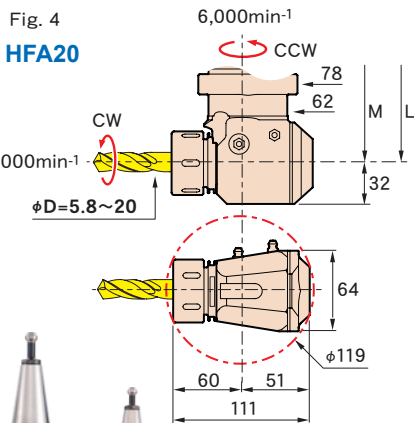
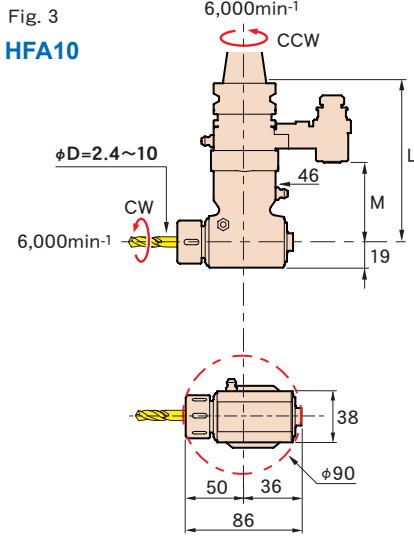
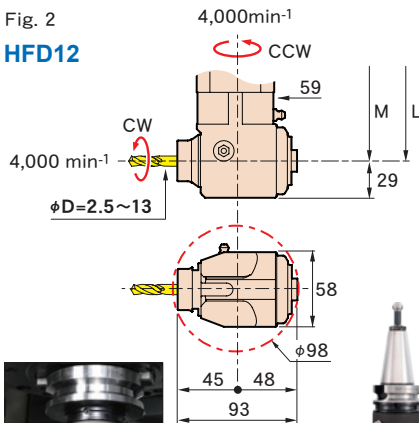
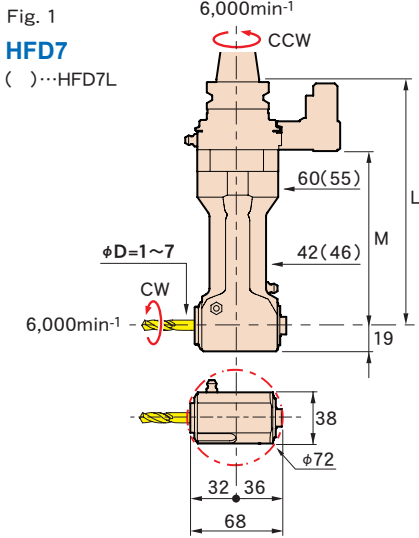

Tap

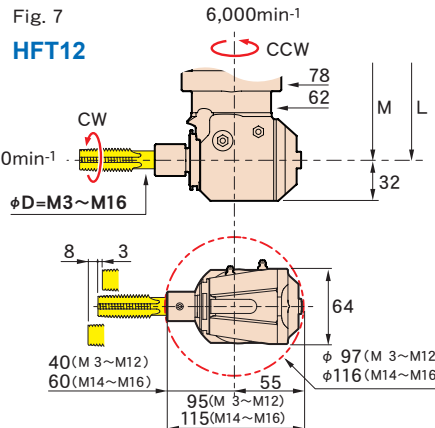
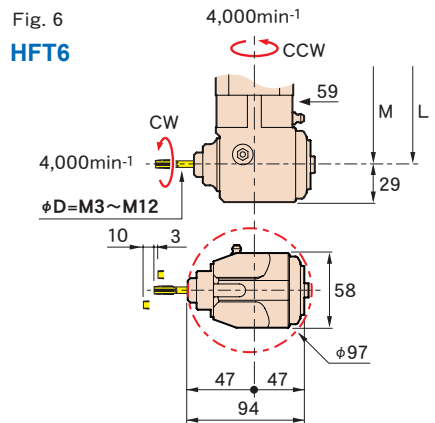
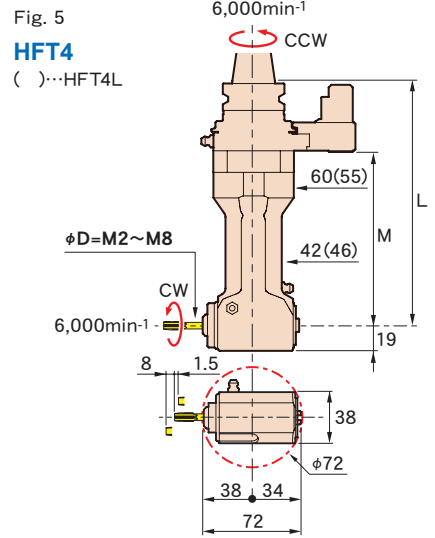

BT40-HFA20-135

BT40-HFD12-120

BT30-HFD7-122

DETa-1 Collet (HFD,HUD)

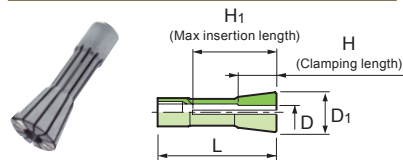

CODE	φD	φD ₁	L	H	H ₁	Holder type
D 7- 1.5	1 ~ 1.5	17	50	7	36	HFD 7 HUD 7
- 2	1.5 ~ 2			10		
- 2.5	2 ~ 2.5			12		
- 3	2.5 ~ 3					
- 4	3 ~ 4			14		
- 5	4 ~ 5			16		
- 6	5 ~ 6					
- 7	6 ~ 7					
D12- 4	2.5 ~ 4	26	70	16	50	HFD12
- 6	4 ~ 6			20		
- 8	6 ~ 8			22		
-10	8 ~ 10					
-12	10 ~ 12					
-13	11 ~ 13					

Tap sleeve (HFT,HUT)

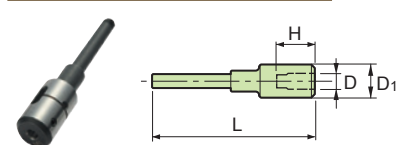

CODE	φD	L	φD ₁	H	Holder type
TA 4-M 2	M 2	67.5	16	19	HFT 4 HUT 4
-M 3	M 3			20	
-M 4	M 4			21	
-M 5	M 5				
-M 6	M 6				
-M 8	M 8				
TA 6-M 3	M 3	92	19	21	HFT 6 HUT 6 HFT12
-M 4	M 4			22	
-M 5	M 5				
-M 6	M 6				
-M 8	M 8			23	
-M10	M10			24	
-M12	M12				
TA12-M14	M14	111.5	25	33	HFT12
-M16	M16			35	

■ Note
 ● Above products meet JIS standards. We can produce other standard Tap sleeves, such as ANSI, ISO, DIN and others. For more information, please contact us.

Spring collet (HFA,HUA)

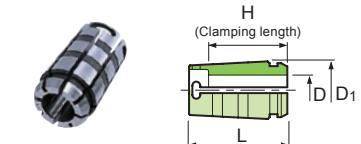

CODE	φD	φD ₁	L	H	Holder type
C10-D	2.6 2.8 3 ... (0.2Steps) ... 9.6 9.8 10	17.2	26	16 (φD=2.6~5) Except for 18 ※3, 4 (φD=3, 4, 20 5.2~5.8) (φD= 6~10)	HFA10 HUA10
C20-D	6 6.2 6.4 ... (0.2Steps) ... 19.8 20	29.5	50	32 (φD= 6~9.8) 35 (φD=10~15.8) 40 (φD=16~20)	HFA10 HUA10

Ex. φD C10-6

CODE (Master holder)	Fig.	φD	L	M	Kg
BT30-HFD 7 -122	1	1 ~ 7	122	70	2.3
			182	130	3.0
			120	57	1.8
-HFD 7L-120			120	57	1.8
-HFD12 -122	2	2.5~ 13	122	70	2.9
-HFA10 -120	3	2.4~ 10	120	65	1.8
-HFT 4 -122	5	M2~M 8	122	70	2.3
			182	130	3.0
			120	57	1.8
-HFT 4L-120			120	57	1.8
-HFT 6 -122	6	M3~M12	122	70	2.9
BT40-HFD 7 -120	1	1 ~ 7	120	70	3.0
			180	130	3.3
-HFD12 -120	2	2.5~ 13	120	70	3.6
-180			180	130	4.9
-HFA20 -135	4	5.8~ 20	135	77	4.4
-195			195	137	5.6
-HFT 4 -120	5	M2~M 8	120	70	3.0
-180			180	130	3.3
-HFT 6 -120	6	M3~M12	120	70	3.6
-180			180	130	4.9
-HFT12 -135	7	M3~M16	135	77	4.4
-195			195	137	5.6
BT50-HFD 7 -195	1	1 ~ 7	195	130	6.4
			255	190	6.8
-HFD12 -135	2	2.5~ 13	135	70	6.3
-195			195	130	7.6
-255			255	190	8.9
-HFA20 -150	4	5.8~ 20	150	77	7.1
-210			210	137	8.3
-270			270	197	9.4
-HFT 4 -195	5	M2~M 8	195	130	6.4
-255			255	190	6.8
-HFT 6 -135	6	M3~M12	135	70	6.3
-195			195	130	7.6
-255			255	190	8.9
-HFT12 -150	7	M3~M16	150	77	7.1
-210			210	137	8.3
-270			270	197	9.4
A63 -HFD 7 -183	1	1 ~ 7	183	130	3.5
			243	190	3.9
-243			243	190	3.9
-HFD12 -123	2	2.5~ 13	123	70	3.3
-183			183	130	4.7
-243			243	190	6.0
-HFA20 -198	4	5.8~ 20	198	137	5.4
-258			258	197	6.5
-HFT 4 -183	5	M2~M 8	183	130	3.5
-243			243	190	3.9
-HFT 6 -123	6	M3~M12	123	70	3.3
-183			183	130	4.7
-243			243	190	6.0
-HFT12 -198	7	M3~M16	198	137	5.4
-258			258	197	6.5

■ A product code example when ordering.

BT40-HFD7-120 - S 65

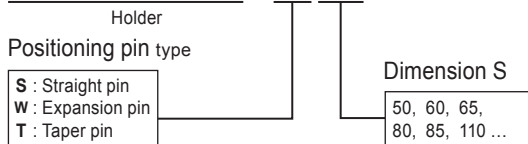

CODE (Master holder)	Fig.	φD	L	M	Kg
DN40A-HFD 7-135	1	1 ~ 7	135	70	3.1
			195	130	3.4
			135	70	3.7
-HFD12-135	2	2.5~ 13	135	70	3.7
-195			195	130	5.0
-HFA20-150	4	5.8~ 20	150	77	4.7
-210			210	137	5.8
-HFT 4-135	5	M2~M 8	135	70	3.1
-195			195	130	3.4
-HFT 6-135	6	M3~M12	135	70	3.7
-195			195	130	5.0
-HFT12-150	7	M3~M16	150	77	4.7
-210			210	137	5.8
DN50A-HFD 7-195	1	1 ~ 7	195	130	5.9
			255	190	6.3
-HFD12-135	2	2.5~ 13	135	70	5.8
-195			195	130	7.1
-255			255	190	8.4
-HFA20-150	4	5.8~ 20	150	77	6.6
-210			210	137	7.8
-270			270	197	8.9
-HFT 4-195	5	M2~M 8	195	130	5.9
-255			255	190	6.3
-HFT 6-135	6	M3~M12	135	70	5.8
-195			195	130	7.1
-255			255	190	8.4
-HFT12-150	7	M3~M16	150	77	6.6
-210			210	137	7.8
-270			270	197	8.9
CT40 -HFD 7-135	1	0.4~.28	5.31	2.75	6.8
			7.68	5.11	7.5
-HFD12-135	2	2.5~ 13	5.31	2.75	8.2
-195			7.68	5.11	11.0
-HFA20-150	4	.23~ .79	5.91	3.03	10.4
-210			8.27	5.39	12.9
-HFT 4-135	5	M2~M 8	5.31	2.75	6.8
-195			7.68	5.11	7.5
-HFT 6-135	6	M3~M12	5.31	2.75	8.2
-195			7.68	5.11	11.0
-HFT12-150	7	#4 ~ 5/8	5.91	3.03	10.4
-210			8.27	5.39	12.9
CT50 -HFD 7-195	1	0.4~.28	7.68	5.11	13.0
			10.04	7.47	13.8
-HFD12-135	2	.10~ .51	5.31	2.75	12.8
-195			7.68	5.11	15.6
-255			10.04	7.47	18.5
-HFA20-150	4	.23~ .79	5.91	3.03	14.7
-210			8.27	5.39	17.3
-270			10.63	7.76	19.8
-HFT 4-195	5	M2~M 8	7.68	5.11	13.0
-255			10.04	7.47	13.8
-HFT 6-135	6	M3~M12	5.31	2.75	12.8
-195			7.68	5.39	15.6
-255			10.04	7.47	18.5
-HFT12-150	7	#4 ~ 5/8	5.91	3.03	14.7
-210			8.27	5.39	17.3
-270			10.63	7.76	19.8

■ Option

- DETa-1 Collet (HFD) • Spring collet (HFA) • Tap sleeve (HFT)
- Retention knob→P.64 • Tools for assembly

■ Std. Access.

- Coolant duct (HSK-A) • Fixing spanner(Except for HFA10/HFT4L)
- Hexagonal wrench set • Spanner(HFA)
- Single-ended wrench(HFD7L/HFA10) • Spanner(HFA) • Low head bolt

■ Note

- Other shanks are also available upon request.

Cutting data
P.13

Parts list
P.105

HALF mini type



BT40-HFCS6-160

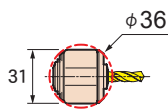
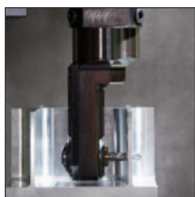
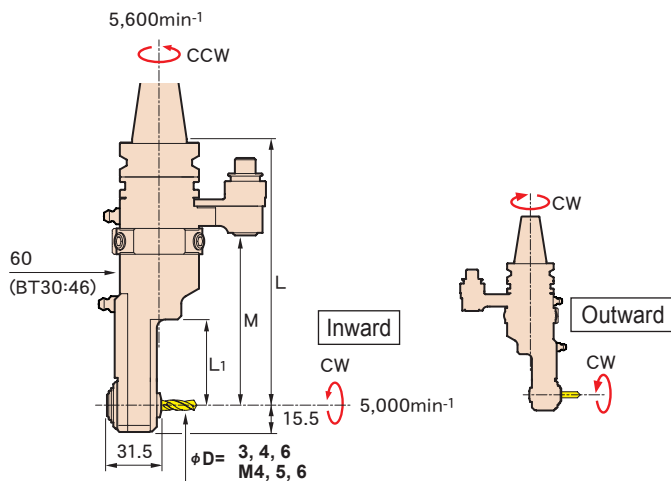

Cutter mounts in two directions

A cutting tool can be mounted both ways, inward or outward, by reassembling the angle shaft.

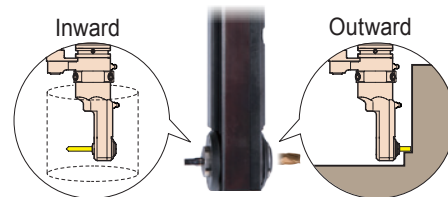

Allows maximum tool holder diameter limitation even when using a long cutting tool.

Minimal interference with face of workpiece.

Collet exchange system

Shaft exchange system for Shrink-fit collet for carbide cutter (end-mill, drill) or Tap collet for Tap.

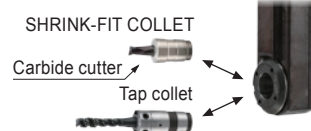

Option

- Shrink-fit collet • Tap collet
- Retention knob → P.64 • Tools for assembly

Std. Access.

- Fixing spanner • Hexagonal wrench set • Low head bolt

Note

- When shipping, the head direction is inward. The tool for assembly (pliers for retaining ring) is required to reassemble the collet to allow for outward positioning of the cutting tool.
- Other shanks such as HSK are also available upon request.

Caution

- The angle axis rotating direction is different due to its mounting direction, inward and outward.

CODE (Master holder)	φD	L	L ₁	M	kg (lbs)
BT30 -HFCS6-155	Drill·Endmill φ3, 4, 6	155	50	100	1.8
BT40 -HFCS6-160		160	50	110	2.8
-205		205	95	155	3.0
BT50 -HFCS6-175	Tap M4, 5, 6	175	50	110	5.6
-220		220	95	155	5.8
DN40A-HFCS6-175	Drill·Endmill φ3, 4, 6	175	50	110	3.0
-220		220	95	155	3.2
DN50A-HFCS6-175	Tap M4, 5, 6	175	50	110	5.1
-220		220	95	155	5.3
CT40 -HFCS6-175	Drill·Endmill φ3, 4, 6	6.89	1.97	4.33	6.61
-220		8.66	3.74	6.10	7.28
CT50 -HFCS6-175	Tap M4, 5, 6	6.89	1.97	4.33	11.24
-220		8.66	3.74	6.10	11.68

Shrink-Fit Collet

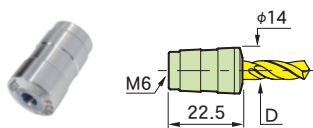

CODE	φD	Holding length
FCS6- 3	3	11~13
- 4	4	
- 6	6	12~13

Caution

- The dedicated shrink-fit collet for the Angle Head Half Mini.
- A shrink-fit heating device is required to insert and remove cutting tools.

Tap collet

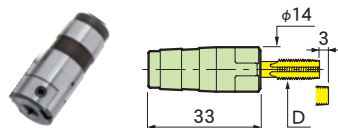

CODE	φD	Holding length
FCS6-M4	M4	16
-M5	M5	
-M6	M6	

Note

- Tap collets meet JIS standards. We can produce ANSI standard tap collet. For more information, please contact us.

■ A product code example when ordering.

BT30-HFCS6-155 - S 65

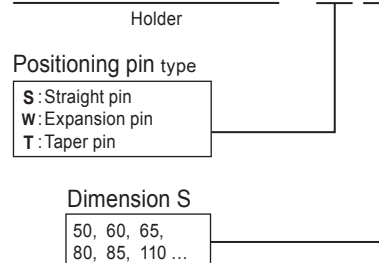

Procedure of cutter insertion to shrink-fit collet

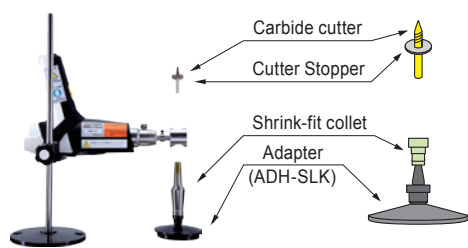

Shrink-fit Heater (HRB-01)

1. Attach the shrink-fit collet to the adapter (ADH-SLK).
2. Heat the shrink-fit collet with the shrink-fit heater.
3. Attach a stopper to the carbide cutter. After finishing heating, insert the cutter to the shrink-fit collet.
4. Cool the shrink-fit collet with the shrink-fit heater.

CODE	Power
HRB-01	100V

Cutting data
→ P.13

Parts list
→ P.105

HALF UNIVERSAL type

Drill · Endmill

Tap

Fig. 1

HUD7

()...BT30

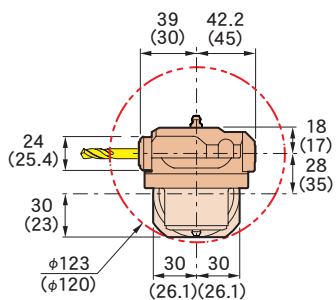
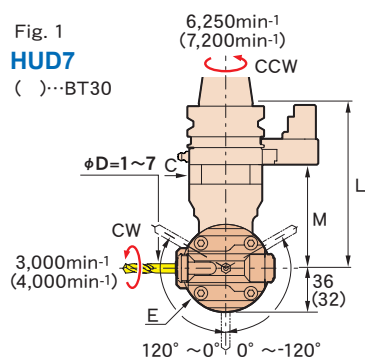

BT40-HUA20-135

Fig. 2

HUA10

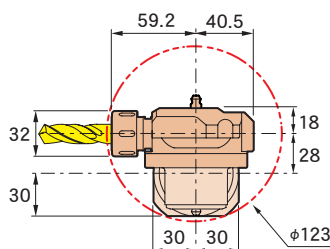
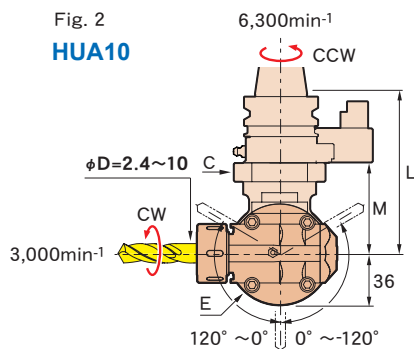

Fig. 3

HUA20

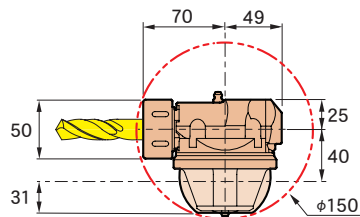
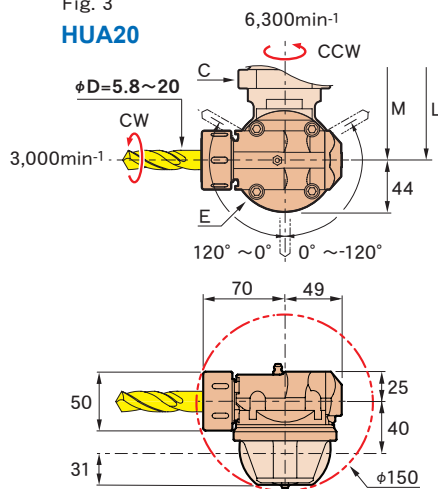

Fig. 4

HUT4

()...BT30

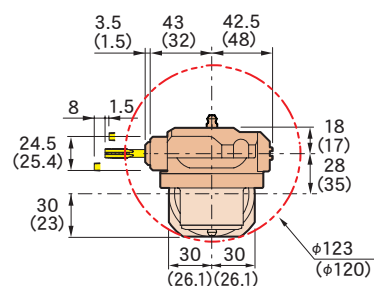
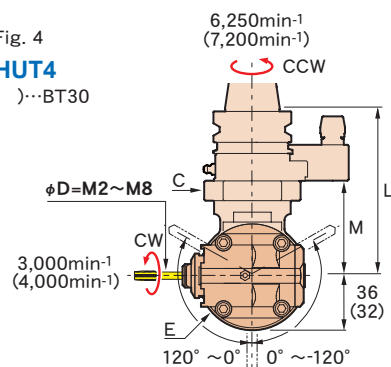
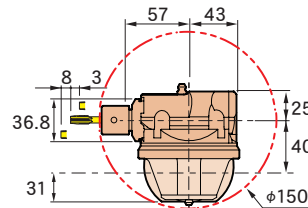
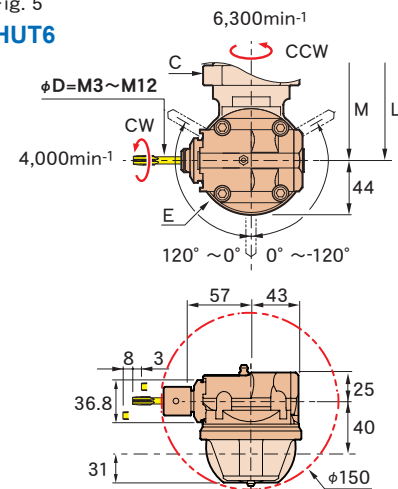



Fig. 5

HUT6



CODE (Master holder)	Fig.	φD	L	M	φC	φE	 Kg (lbs)	Moment kgf·mm
BT30 -HUD 7-102	1	1 ~ 7	102	39	46	64	1.8	116
	4	M2 ~ M 8						
BT40 -HUD 7-135	1	1 ~ 7	135	85	60	72	3.8	251
	2	2.4 ~ 10						
	3	5.8 ~ 20						
	4	M2 ~ M 8						
	5	M3 ~ M12						
	7	M2 ~ M 8						
BT50 -HUD 7-150	1	1 ~ 7	150	85	60	72	6.6	277
	2	2.4 ~ 10						
	3	5.8 ~ 20						
	4	M2 ~ M 8						
	5	M3 ~ M12						
	7	M2 ~ M 8						
DN40A -HUD 7-150	1	1 ~ 7	150	85	60	72	3.8	251
	2	2.4 ~ 10						
	3	5.8 ~ 20						
	4	M2 ~ M 8						
	5	M3 ~ M12						
	7	M2 ~ M 8						
DN50A -HUD 7-150	1	1 ~ 7	150	85	60	72	6.6	277
	2	2.4 ~ 10						
	3	5.8 ~ 20						
	4	M2 ~ M 8						
	5	M3 ~ M12						
	7	M2 ~ M 8						
CT40 -HUD 7-150	1	.04 ~ .28	5.91	3.3	2.4	2.8	8.4	251
	2	.09 ~ .39						
	3	.23 ~ .79						
	4	M2 ~ M 8						
	5	#4 ~ 1/2						
CT50 -HUD 7-150	1	.04 ~ .28	5.91	3.3	2.4	2.8	14.6	277
	2	.09 ~ .39						
	3	.23 ~ .79						
	4	M2 ~ M 8						
	5	#4 ~ 1/2						

※Distance from a gage line to center of gravity × weight (kg · mm)

- **Option**
 - DETa-1 Collet (HUD)→P.8 • Spring collet (HUA)→P.8
 - Tap sleeve (HUT)→P.8 • Retention knob→P.64 • Tools for assembly
- **Std. Access.**
 - Fixing spanner • Hexagonal wrench set • Spanner (HUA) • Low head bolt
- **Note**
 - Other shanks such as HSK are also available upon request.



■ A product code example when ordering.

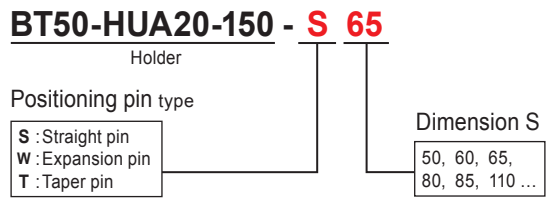

Cutting data

90° type

<p>S55C $\phi 12$ Drill</p> <p>n 670 min⁻¹ Vf 80 mm/min Vc 25.5 m/min f 0.12 mm/rev</p> <p>BT40-HFD12-120</p>	<p>S55C M12 Tap</p> <p>n 184 min⁻¹ Vf 322 mm/min Vc 7 m/min</p> <p>BT40-HFT6-120</p>	<p>S50C M16 Tap</p> <p>n 60 min⁻¹ Vf 120 mm/min Vc 3 m/min</p> <p>BT40-HFT12-135</p>	<p>S55C $\phi 10$ Endmill 2-flutes</p> <p>n 350 min⁻¹ Vf 50 mm/min Vc 11 m/min fz 0.07 mm/t</p> <p>BT40-HFD12-120</p>	<p>S50C $\phi 20$ Endmill 2-flutes</p> <p>n 158 min⁻¹ Vf 32 mm/min Vc 10 m/min fz 0.10 mm/t</p> <p>BT40-HFA20-135</p>
--	--	--	---	---

mini type

<p>S50C $\phi 6$ Carbide drill</p> <p>n 5000 min⁻¹ Vf 250 mm/min Vc 94 m/min f 0.05 mm/rev</p> <p>BT30-HFCS6-155</p>	<p>S50C $\phi 6$ Carbide endmill 2-flutes</p> <p>n 3500 min⁻¹ Vf 210 mm/min Vc 66 m/min fz 0.03 mm/t</p> <p>BT40-HFCS6-205</p>	<p>A7075 $\phi 6$ Carbide endmill 2-flutes</p> <p>n 5000 min⁻¹ Vf 300 mm/min Vc 94 m/min fz 0.03 mm/t</p> <p>BT30-HFCS6-155</p>
---	--	---

UNIVERSAL type

<p>S50C $\phi 10$ Endmill 2-flutes</p> <p>n 900 min⁻¹ Vf 100 mm/min Vc 28 m/min fz 0.06 mm/t</p> <p>BT50-HUA10-150</p>	<p>S50C M8 Tap</p> <p>n 250 min⁻¹ Vf 312 mm/min Vc 6.3 m/min</p> <p>BT40-HUT4-135</p>	<p>S50C M12 Tap</p> <p>n 184 min⁻¹ Vf 322 mm/min Vc 7 m/min</p> <p>BT40-HUT6-135</p>	<p>SUS304 $\phi 10$ Drill</p> <p>n 314 min⁻¹ Vf 16 mm/min Vc 9.9 m/min f 0.05 mm/rev</p> <p>BT50-HUA10-150</p>	<p>S50C $\phi 16$ Endmill 2-flutes</p> <p>n 140 min⁻¹ Vf 40 mm/min Vc 7 m/min fz 0.14 mm/t</p> <p>BT40-HUA20-135</p>
--	---	--	---	--

ANGLE HEAD STANDARD type

High-rigidity standard type for end-milling applications

MODULAR type

Shank and head can be combined freely to match the application.

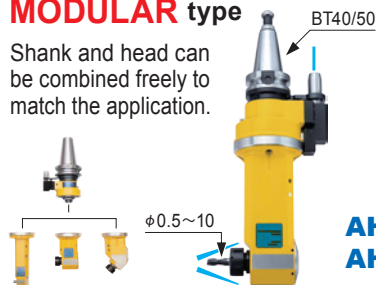

SOLID type

The popular type that can chuck small-to large-diameter cutters.

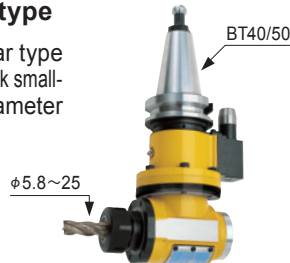

FLANGE type

Heavy-duty type that mounts directly on the machine spindle surface.

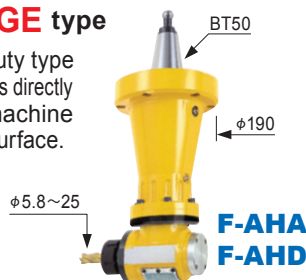

UNIVERSAL type

Cutting angle can be adjusted arbitrarily.

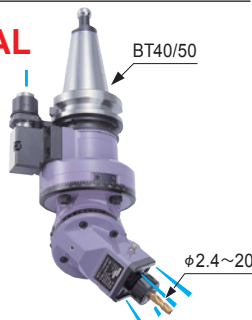

Use of collet holder

To chuck a cutting tool, the collet chuck system is used, which has a long history of good performance. This product is applicable to all the types of machining, including drilling and milling.

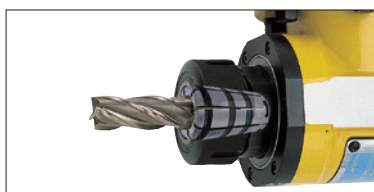

Compact design

Ideal for internal machining.

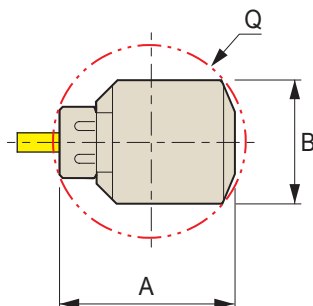

Type	Model	Q	A	B
MODULAR type	AHB 5	62	57	46
	AHB 7	76	72	56
	AHB10	96	88	62
SOLID type FLANGE type	AHA20	171	160	88
	AHA25	193	180	90
UNIVERSAL type	AHU10	156	154	27.5
	AHU20	192	188.5	35

Body-through coolant

Coolant can be feed from a closer position to the cutting edge. Prevents heat generation inside the body to achieve high-speed rotation. (MODULAR type, UNIVERSAL type)

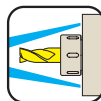

MST's Quick Change system(AHD type)

By adopting the BT30 Quick Change mechanism at the angle axis, a large variety of machining applications are made possible.



Highest Guaranteed Accuracies

All standard type angle heads have passed an accuracy test and rotation test.

Squareness

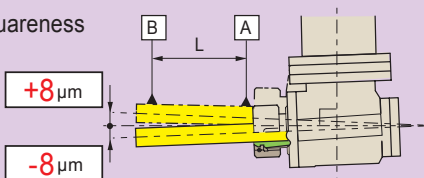

Runout accuracy

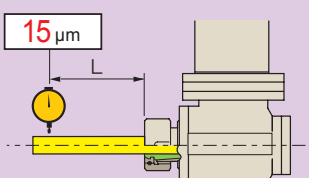

Type	Model	L
MODULAR type	AHB 5 AHB 7 AHB10 AHC10	40
	UNIVERSAL type	AHU10
	SOLID type FLANGE type	AHA20 AHA25 AHD30
UNIVERSAL type		AHU20

M/C Tool

HSK-T Tooling Systems for Turning Mill

General Purpose Tool

JIG

Measuring Equipment

Maintenance Tool

Wire EDM fixture

Technical Information

STANDARD type MODULAR type

Shank and head can be combined freely to match the application.

▷ Various types of shanks and heads are freely combined to meet your machining needs.

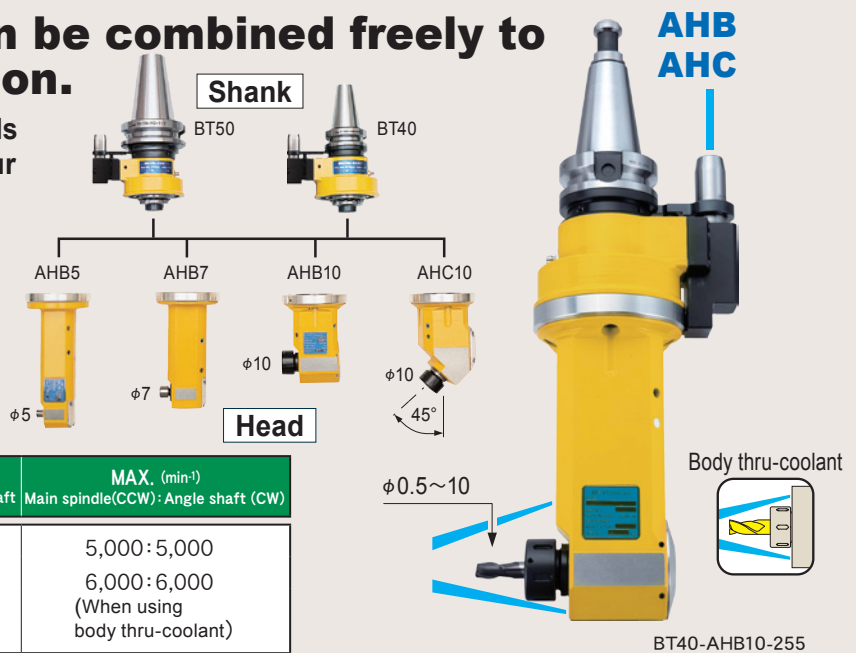

MODEL	Chucking range	Gear ratio Main spindle:Angle shaft	MAX. (min ⁻¹)
			Main spindle(CCW): Angle shaft (CW)
AHB 5	φ0.5~ 5	1:1	5,000:5,000
AHB 7	φ0.5~ 7		6,000:6,000
AHB10	φ2.4~10		(When using body thru-coolant)
AHC10			

Fig. 1

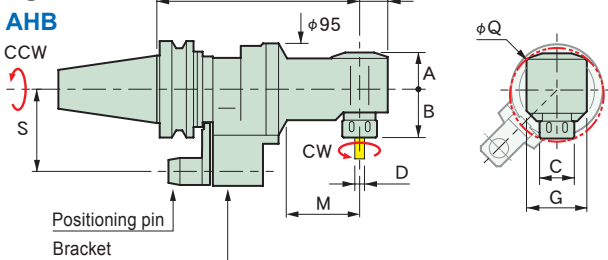
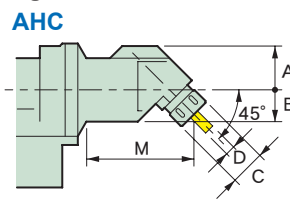

Fig. 2



CODE	Fig.	φD	L	φC	L1	M	A	B	G	φQ	Kg	
BT40-AHB 5-210	1	0.5~ 5	210	12	20	85	25	32	46	62	5.5	ER8
-270			270			145					6.4	
-AHB 7-180		0.5~ 7	180	19	22	60	29	43	56	76	5.3	ESX12
-240			240			120					6.6	
-AHB10-195	2	2.4~10	195	36	29	80	38	50	62	96	6.2	C10
-255			255			140					7.9	
-AHC10-230		230	—	110	45	32.5	65	—	6.2			
BT50-AHB 5-225		1	0.5~ 5	225	12	20	85	25	32	46	62	8.8
-285	285			145			9.7					
-AHB 7-195	0.5~ 7		195	19	22	60	29	43	56	76	8.6	ESX12
-255			255			120					9.9	
-AHB10-210	2.4~10	210	36	29	80	38	50	62	96	9.5	C10	
-270		270			140					11.2		

Available for
DIN / CAT.

Cutting data
P.20

■Option

- Spring collet→P.19
- Retention knob →P.64
- Semi-finished positioning block→P.19

■Std. Access.

- A complete set of spanners and wrenches.

■Note

- The phase of the drive key and the positioning pin is set freely.
- Standard specifications:
S = 60 mm, 65 mm (BT40), 80 mm, 85 mm, and 110 mm (BT50).
- Other shanks such as HSK are also available upon request.

■Caution

- For the shape and mounting position of the positioning block, contact the machine manufacturer or MST.
- The height of the positioning pin depends on the shape of the positioning block.
- The machine spindle and angle shaft should rotate in reverse directions, so make sure the spindle rotates in the reverse direction.
- For precautions and maintenance, refer to page 115.

Shank / Head reference list

CODE	Shank	Head
BT40-AHB 5-210	BT40-MS- 98	MB 5-112
-270		-172
-AHB 7-180		MB 7- 82
-240		-142
-AHB10-195	BT50-MS-113	MB10- 97
-255		-157
-AHC10-230		MC10-132
BT50-AHB 5-225		MB 5-112
-285	-172	
-AHB 7-195	MB 7- 82	
-255	-142	
-AHB10-210	MB10- 97	
-270	-157	
-AHC10-245	MC10-132	

STANDARD type **SOLID** type

The popular type that can chuck small- to large-diameter cutters.

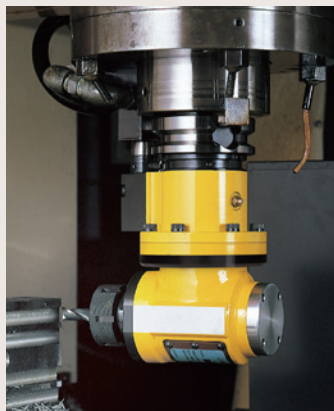

BT50-AHA25-195

MODEL	Chucking range	Gear ratio		MAX. (min ⁻¹)
		Main spindle : Angle shaft	Main spindle(CCW):Angle shaft(CW)	
AHA20	φ 5.8~20	1 : 0.81		3000 : 2430
AHA25	φ 5.8~25	1 : 0.96		2500 : 2400
AHD30	BT30 tools			

Fig. 1
AHA

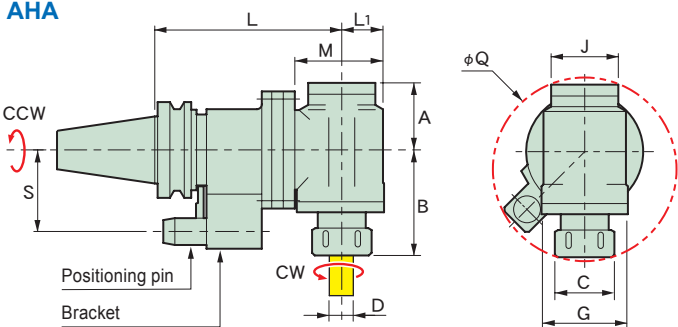
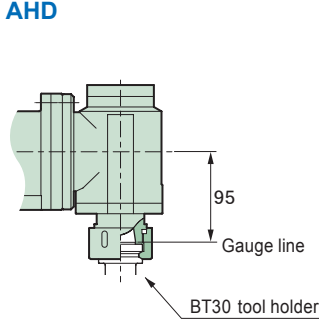

Fig. 2
AHD



CODE	Fig.	φD	L	L ₁	M	A	B	G	φC	J	φQ	Kg	
BT40-AHA20-160	1	5.8~20	160	40	86	65	95	88	50	65	171	7.3	C20
BT50-AHA20-195	1	5.8~20	195	40	92	65	95	88	50	65	171	13.1	C20
-250			249									14.8	
-AHA25-195	1	5.8~25	195	44	97	70	110	90	62	70	193	13.6	C25
-250			249									15.3	
-AHD30-195	2	—	195	44	97	70	112.6	90	66	70	193	14.7	—

■ **Option**

- Spring collet → P.19
- Retention knob → P.64
- Semi-finished positioning block → P.19

■ **Std. Access.**

- A complete set of spanners and wrenches

■ **Note**

- The phase of the drive key and the positioning pin is set freely.
- Standard specifications: S = 60 mm, 65 mm (BT40), 80 mm, 85 mm, and 110 mm (BT50).
- Other shanks such as HSK are also available upon request.

■ **Caution**

- For the shape and mounting position of the positioning block, contact the machine manufacturer or MST.
- The height of the positioning pin depends on the shape of the positioning block.
- The machine spindle and angle shaft should rotate in reverse directions, so make sure the spindle rotates in the reverse direction.
- For precautions and maintenance, refer to page 115.

Available for
DIN / CAT.

Cutting data
→ P.20

STANDARD type FLANGE type

Ideal for heavy cutting by mounting the angle head flange type directly on the machine spindle surface.

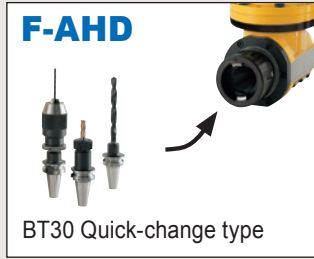

MODEL	Chucking range	Gear ratio		MAX. (min ⁻¹)
		Main spindle: Angle shaft	Main spindle(CCW):Angle shaft(CW)	
AHA20	φ5.8~20	1:0.81		3000:2430
AHA25	φ5.8~25	1:0.96		2500:2400
AHD30	BT30 tools	1:0.96		



Fig. 1

AHA

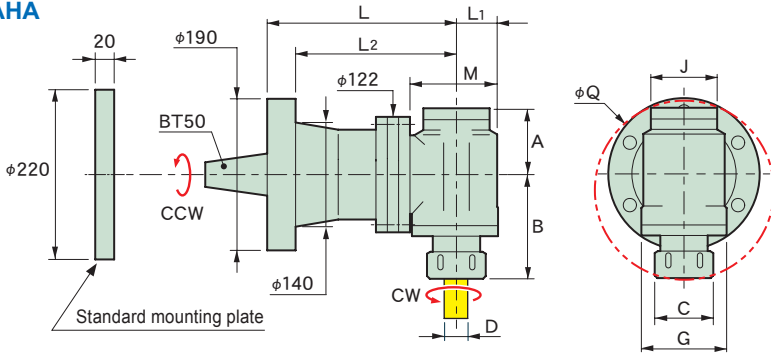
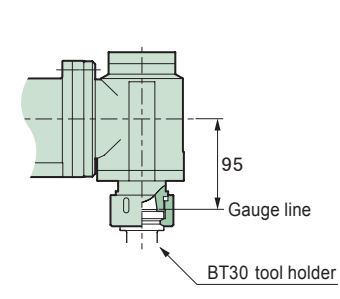

Fig. 2

AHD



CODE	Fig.	φD	L	L ₁	L ₂	M	A	B	G	φC	J	φQ	kg	
F190-AHA20-200	1	5.8~20	200	40	160	92	65	95	88	50	65	171	18	C20
			350		310								28	
-AHA25-200		5.8~25	200	44	160	97	70	110	90	62	70	193	18.5	C25
			350		310								28.5	
-AHD30-200	2	—	200		160					66			19.6	—
			350		310								29.8	

■Option

- Spring collet→P.19
- Retention knob →P.64

■Std. Access.

- A complete set of spanners and wrenches
- Standard mounting plate(No mounting holes are provided.)
- Mounting bolts for ANGLE HEAD

■Note

- NT50U shank is also available.

■Caution

- For mounting plate shapes and mounting bolt location, contact the machine manufacturer or MST.
- The machine spindle and angle shaft should rotate in reverse directions, so make sure the spindle rotates in the reverse direction.
- For precautions and maintenance, refer to page 115.

STANDARD type UNIVERSAL type

Machining at every angle is possible with just this one unit.

Splash coolant-through body

Whatever machining angle is set, coolant is properly supplied to the cutting edge.

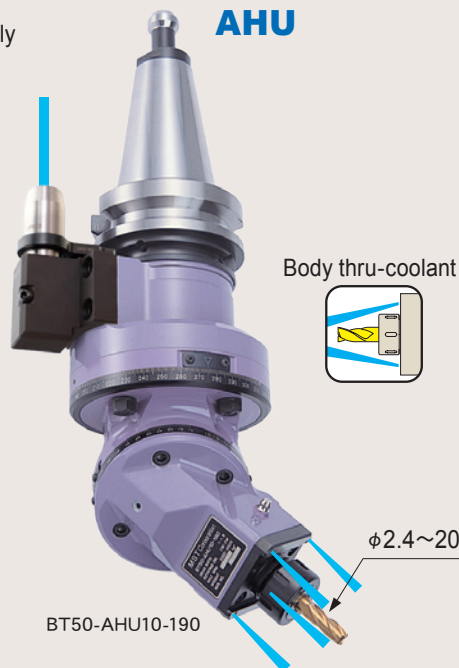
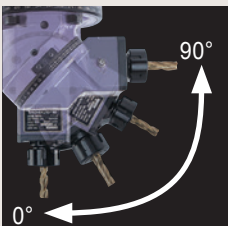
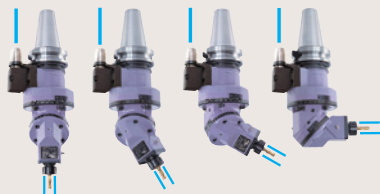

MODEL	Chucking range	Gear ratio		MAX. (min ⁻¹)
		Main spindle : Angle shaft	Main spindle(CW) : Angle shaft(CW)	Main spindle(CW) : Angle shaft(CW)
AHU10	φ2.4~10	1 : 1.5		3000 : 4500
AHU20	φ5.8~20	1 : 1		3000 : 3000

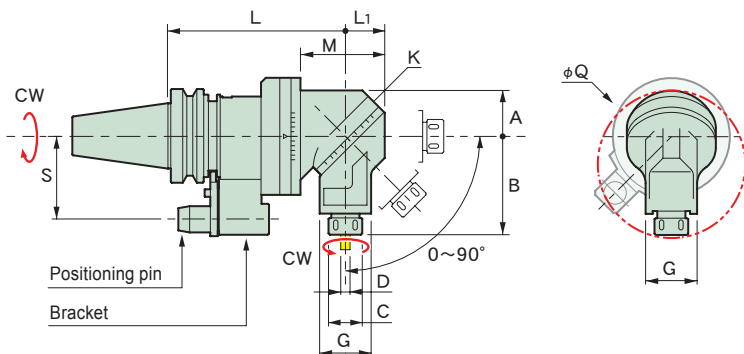

CODE	φD	L	L ₁	M	A	B	K	G	φC	φQ	Kg	Icon
BT40-AHU10-175	2.4~10	175	42	96	49	105	95	55	32	156	9.6	C10
BT50-AHU10-190	2.4~10	190	42	90	49	105	95	55	32	192	13.9	C10
-AHU20-200	5.8~20	200	54	112	58.5	130	120	70	50		15.8	C20

- Option
 • Spring collet →P.19 • Retention knob →P.64 • Semi-finished positioning block →P.19 • Test bar

- Std. Access.
 • A complete set of spanners and wrenches

- Note
 • The phase of the drive key and the positioning pin is set freely.
 • Standard specifications: S = 60 mm, 65 mm (BT40), 80 mm, 85 mm, and 110 mm (BT50).
 • Products other than BT shanks can be manufactured upon request.

- Caution
 • For the shape and mounting position of the positioning block, contact the machine manufacturer or MST.
 • The machine spindle and angle shaft should rotate in reverse directions, so make sure the spindle rotates in the reverse direction.
 • The machine spindle and angle shaft should rotate in forward directions, so make sure the spindle rotates in the forward direction.
 • For precautions and maintenance, refer to page 115.

Test bar

Use for super accurate angle adjustment.

CODE	Holder type
TBU10	AHU10
TBU20	AHU20



Available for
DIN / CAT.

Cutting data
→ P.20

M/C Tool

HSK-T Tooling Systems for Turning Mill

General Purpose Tool

JIG

Measuring Equipment

Maintenance Tool

Wire EDM fixture

Technical Information

SPRING COLLET

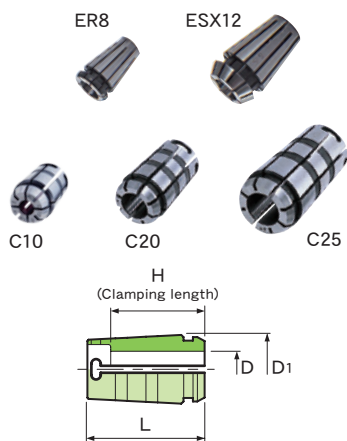

CODE	ϕD	ϕD_1	L	H	Holder type
ER8-D	1 ~ 5 (0.5 Steps)	8.5	13.5	-	AHB 5
ESX12-D	1 ~ 3 (0.5 Steps)	12	19.5	-	AHB 7
	4 ~ 7 (1.0 Steps)				
C10-D	2.6 ~ 5.8 (0.2 Steps)	17.2	26	18	AHB10
	6 ~ 10 (0.2 Steps)			20	AHC10 AHU10
C20-D	6 ~ 9.8 (0.2 Steps)	29.5	50	29	AHA20
	10 ~ 15.8 (0.2 Steps)			33	AHU20
	16 ~ 20 (0.2 Steps)			40	
C25-D	6, 8	36.5	68	35	AHA25
	10 ~ 15 (0.5 Steps)			46	
	15.5 ~ 20 (0.5 Steps)			54	
	20.5 ~ 25 (0.5 Steps)			57	

■ Option
 ● Collet remover (C10, C20) → P.38

Semi-finished positioning block

The semi-finished positioning block must be modified to the appropriate shape by the customer after delivery. Determine the shape and dimensions as follows, and then modify the positioning block as necessary.

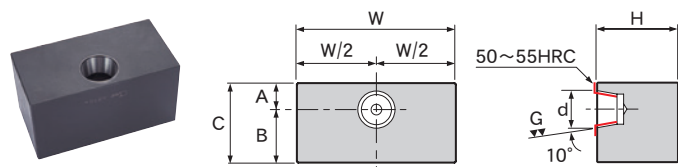

CODE	A	B	C	W	H	d	Spindle	Material
AB-15	15	43	58	92	58	20	BT40	S50C
-12	20		63	120	63	28	BT50	

1. Obtain the machine manufacturer's drawing for the positioning block and modify the positioning block in accordance with that drawing.
2. Determine the dimensions as shown in the instruction and then modify.
 - This block may not be applicable for dimensional reasons. Carefully check to see whether the positioning block is applicable.
 - The positioning block exclusively for your machine may also be available on request.
 - For further information, please contact MST.

Custom-made products

We are proud of our over 35 years of experience custom making products for our customers. We can produce the best product for you depending on your applications such as O.D and I.D machining thanks to our accumulated know-how.

35
years

Manufacturing history

1
unit

Production starting from just 1 unit

2~4
months

Delivery

19,300
units

Custom : 1,300 units
Design
Standard : 18,000 units

ANGLE HEAD CUSTOM DESIGN



For more information, please contact us.

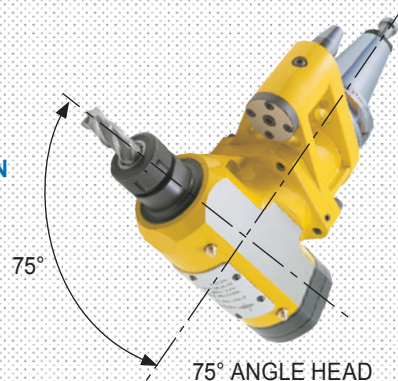



<h4>Dual side machining ANGLE HEAD</h4> <p>Medical equipment AL MAX 1500min⁻¹ BT50</p>	<h4>Side face machining ANGLE HEAD</h4> <p>MAX 400min⁻¹ Direct mount</p>
<h4>Internal bore surface machining ANGLE HEAD</h4> <p>AL MAX 2650min⁻¹ BT50</p>	<h4>Internal bore surface machining ANGLE HEAD</h4> <p>MAX 4500min⁻¹ Direct mount</p>

Cutting data

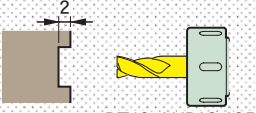
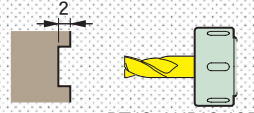
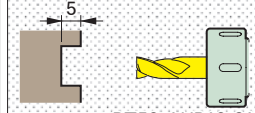
MODULAR type

<p>SUS304 $\phi 10$</p> <p>n 640 min⁻¹ Endmill Vf 60 mm/min 2 flutes Vc 20 m/min fz 0.05 mm/t</p>  <p>BT40-AHB10-195</p>	<p>A2017 $\phi 10$</p> <p>n 4000 min⁻¹ Carbide Vf 400 mm/min endmill Vc 126 m/min 2 flutes fz 0.05 mm/t</p>  <p>BT40-AHB10-195</p>	<p>S50C $\phi 10$</p> <p>n 640 min⁻¹ Endmill Vf 60 mm/min 2 flutes Vc 20 m/min fz 0.05 mm/t</p>  <p>BT50-AHB10-210</p>
---	---	---

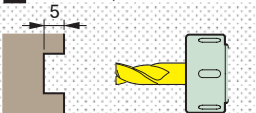
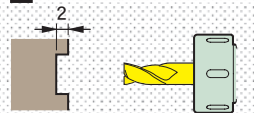
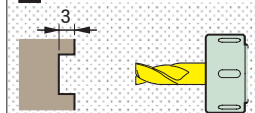
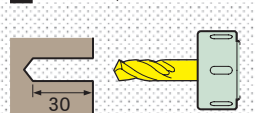
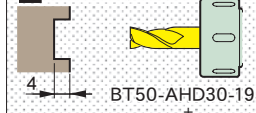
SOLID type

<p>A2017 $\phi 16$</p> <p>n 1800 min⁻¹ Endmill Vf 130 mm/min 2 flutes Vc 90 m/min fz 0.04 mm/t</p>  <p>BT50-AHA25-195</p>	<p>SUS304 $\phi 12$</p> <p>n 527 min⁻¹ Endmill Vf 20 mm/min 2 flutes Vc 60 m/min fz 0.06 mm/t</p>  <p>BT40-AHA20-160</p>	<p>SUS304 $\phi 16$</p> <p>n 570 min⁻¹ Endmill Vf 40 mm/min 2 flutes Vc 29 m/min fz 0.04 mm/t</p>  <p>BT50-AHA25-195</p>	<p>S55C $\phi 12$</p> <p>n 527 min⁻¹ Drill Vf 39 mm/min 2 flutes Vc 20 m/min f 0.07 mm/rev</p>  <p>BT40-AHA20-160</p>	<p>FC30 $\phi 12$</p> <p>n 816 min⁻¹ Endmill Vf 60 mm/min 2 flutes Vc 31 m/min fz 0.04 mm/t</p>  <p>BT50-AHD30-195 BT30-CTA20-45</p>
<p>S50C $\phi 16$</p> <p>n 630 min⁻¹ Endmill Vf 80 mm/min 2 flutes Vc 32 m/min fz 0.06 mm/t</p>  <p>BT50-AHA25-195</p>				

UNIVERSAL type

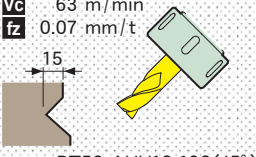
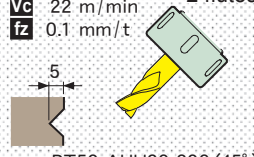
<p>A2017 $\phi 10$</p> <p>n 2000 min⁻¹ Endmill Vf 200 mm/min 2 flutes Vc 63 m/min fz 0.07 mm/t</p>  <p>BT50-AHU10-190(45°)</p>	<p>S50C $\phi 20$</p> <p>n 350 min⁻¹ Carbide Vf 70 mm/min endmill Vc 22 m/min 2 flutes fz 0.1 mm/t</p>  <p>BT50-AHU20-200(45°)</p>
---	---

M/C Tool

HSK-T Tooling Systems for Turning Mill

General Purpose Tool

JIG

Measuring Equipment

Maintenance Tool

Wire EDM fixture

Technical Information

M/C Tool

Pull collet type collet chuck
DETa-1
Collet Holder



DTA
DTB
DTE

➔ P. 22

Retension knob

➔ P. 64

Taper collet chuck
COLLET HOLDER



CTH
CTA

➔ P. 32

Needle-roller type chuck
Hi-ART
MILLING CHUCK



ART

➔ P. 40

End-mill holder for ultra-heavy duty application
SUMMIT



SLZ

➔ P. 43

The face mill arbor for through-spindle coolant
FMH RIGID type



FMH-H

Carbide core

➔ P. 46

The arbor for screw-in End Mill
RED SCREW arbor



RSG

Carbide integral type

➔ P. 48

Cutter arbor with spindle-through coolant
FMH



FMH

➔ P. 53

Fine adjustment boring holder
MICRO HEAD



MFA
MBH
MBJ

➔ P. 55

DETa-1 Collet Holder

Pull collet type collet chuck

2mm collapsibility with just one collet !!

- ▷ Just 6 collets is all it takes to chuck 106 sizes of drills.
- ▷ Slim design due to no tightening nut at the tip of holder.
- ▷ Compatible with synchronized tapping. Provides simple tooling lay-out.



▶ **DETa-1**



Pull collet design

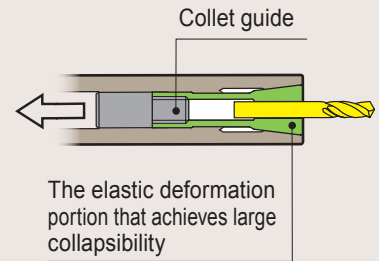

DTA

Nut-tightening type of easy operation

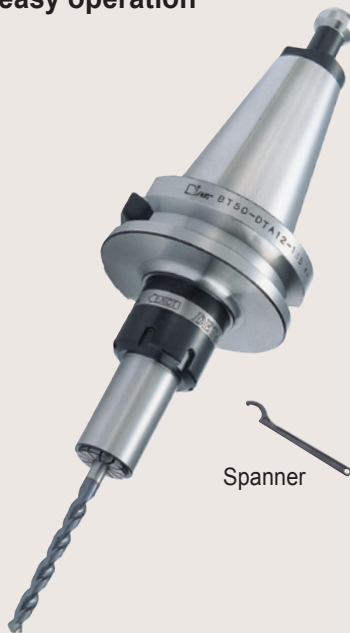

DTB

For high-speed cutting, High cost performance



DTE

Fully applicable for coolant-through

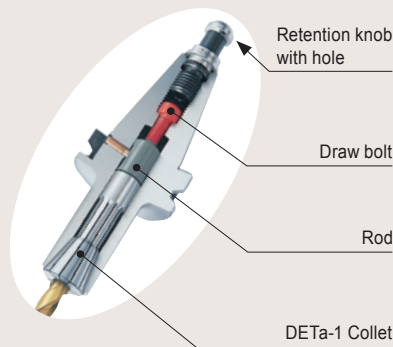
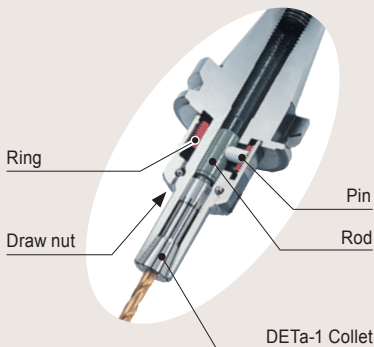

	φD
DTE 7	29
DTE12	40

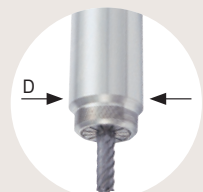

DETa-1 Collet

Using a high-precision collet will increase the life of your tools.
 → P. 117

Highest guaranteed accuracies throughout entire chucking range (100% inspection).

Both large collapsibility and precise chucking achieved by the pull collet design.

Collet	Run-out accuracy (μm)	
	D3	D7/D12
Precision Collet	3 (6)	5 (10)
Standard Collet	5 (10)	10 (15)

※Accuracy of collet alone, () means collapsibility usable.

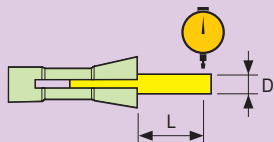

D	L
~10	4×D
10~13	40



Slim and compact without the nut at the tip.

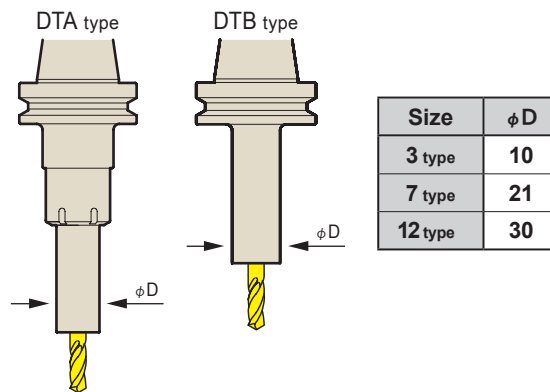

Pre-balanced design (DTE type)

The collet holder is pre-balanced by previously designing the holder to be as axisymmetrical as possible. When used with the precision collet, it enables stable machining during high-speed machining.

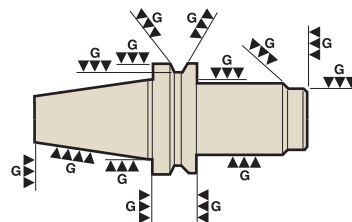

Longer cutter life using through-spindle capability
 → P. 117

Reduces the number of conventional collets needed by 90% (in-house comparison)

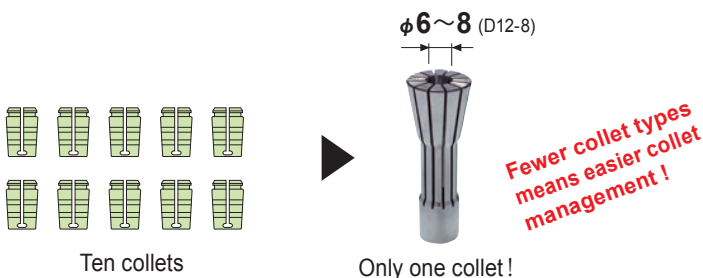

D3 Collet

DTA3
DTB3

Uses a maraging steel. Initial accuracy lasts for a long period of time.



φ0.5~3.175 **8 pcs.**

D7 Collet

DTA7
DTB7
DTE7

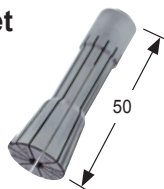

φ1~7 **8 pcs.**

D12 Collet

DTA12
DTB12
DTE12



φ2.5~13 **6 pcs.**

Coolant-through system

Pressure **7 Mpa**

Multiple coolant supply systems. The best methods can be chosen from three options.



Coolant-through cutter

For a cutting tool with oil holes. The shank of the cutting tool is sealed with an O-ring, enabling reliable coolant supply. Compatible with small-diameter cutting tools starting from 3 mm.

DTE type



“SUKIMA-through” coolant-around tool

High-pressure coolant performance can be obtained even when using a cutting tool without oil holes.

DTE type



Coolant-through collet

Coolant is supplied through the slits in the collet. No dedicated optional parts are required.

DTB type
DTE type

DETA-1 Collet Holder A type (DTA)

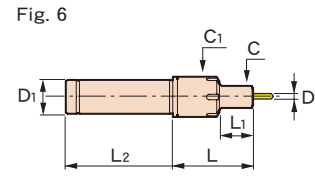
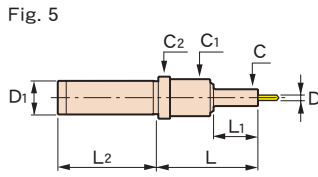
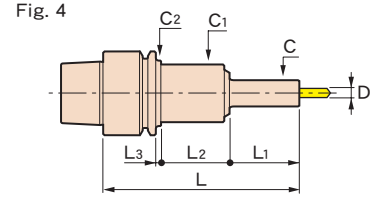
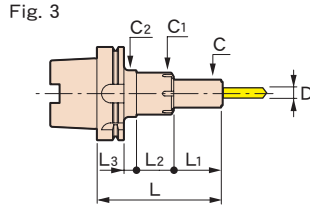
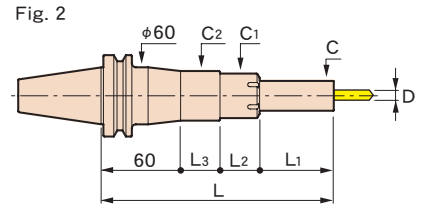
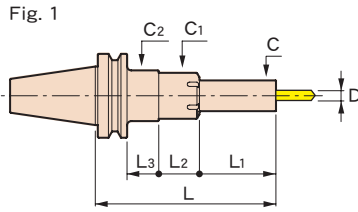
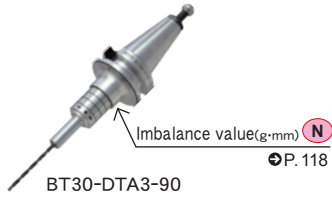

CODE	Fig.	φD	L	φC	L1	L2	L3	φC1	φC2	φD1	kg	N	
BT30-DTA 3- 90	1	0.5 ~ 3.175	90	10	27	26	15	22	25	—	0.5	2.4	
-DTA 7- 90		1 ~ 7		21	30	37	1	38	42	—	0.7	6.7	
-120			120		60						0.8	7.9	
-DTA12-120		2.5 ~ 13		30	52.5	42	3.5	45	45		1.0	10.4	
BT40-DTA 3- 95	1	0.5 ~ 3.175	95	10	27	26	15	22	25	—	1.1	3.9	
-125			125				45				1.2	4.3	
-DTA 7-105		1 ~ 7	105	21	38	37	3	38	60		1.3	8.5	
-135			135		60		11		43		1.4	9.5	
-165			165				41				1.7	10.8	
-195			195				71				2.1	12.1	
-DTA12-120		2.5 ~ 13	120	30	52.5	40	0.5	45	58		1.5	11.6	
-150			150		75		8		50		1.7	13.8	
-180			180				38				2.1	15.5	
-210			210				68				2.6	17.1	
BT50-DTA 7-105	1	1 ~ 7	105	21	30	37	—	38	—	—	3.8	15.5	
-135				135		60					3.9	16.6	
-165				165				30		43		4.0	18.0
-195				195				60				4.4	19.5
-255				255				120				5.0	18.2
-315			2	315								5.9	19.1
-DTA12-135	1	2.5 ~ 13	135	30	52.5	40	4.5	45	50		4.1	19.4	
-165				165		75		12			4.3	21.6	
-195				195				42			4.7	23.4	
-255				255				102			5.5	22.3	
-315			2	315							6.6	23.3	
A63 -DTA 3- 90	3	0.5 ~ 3.175	90	10	27	26	11	22	25	—	0.8	3.0	
-120				120				41			1.0	3.4	
-DTA 7-105		1 ~ 7	105	21	30	37	12	38	50		1.1	17.3	
-120			120		38		19				1.3	18.3	
-150			150		60		27				1.7	20.3	
-DTA12-120		2.5 ~ 13	120	30	52.5	40	1.5	45			1.2	21.9	
-150			150		75		9				1.4	25.2	
-180			180				39				1.8	27.7	

CODE	Fig.	φD	L	φC	L1	L2	L3	φC1	φC2	φD1	Kg (lbs)	N	
A100 -DTA 7-135	3	1 ~ 7	135	21	30	37	39	38	50	—	2.7	33.8	
-165			165		60						2.8	35.5	
-225			225		99						3.7	33.6	
-DTA12-135		2.5~13	135	30	52.5	40	13.5	45	2.7		37.1		
-165			165		75		21		2.9		40.4		
-225			225		81		81		3.8		39.7		
E32 -DTA 3- 75	4	0.5~ 3.175	75	10	27	26	2	22	25	—	0.2	1.8	
E40 -DTA 3- 75	4	0.5~ 3.175	75	10	27	26	2	22	25	—	0.3	1.7	
E50 -DTA 3- 80	4	0.5~ 3.175	80	10	27	26	1	22	25	—	0.5	2.1	
F63 -DTA 3- 90	4	0.5~ 3.175	90	10	27	26	11	22	25	—	0.8	2.3	
-120			120				41				27	26	0.9
DN40A -DTA 3- 95	1	0.5~ 3.175	95	10	27	26	10.8	22	25	—	1.1	4.6	
-125			125				40.8				1.2	5.0	
DIN -DTA 7-105		1 ~ 7	105	21	30	43.8	12.1	38	45		1.2	11.9	
-135			135		60		37				18.9	1.3	14.4
-DTA12-130		2.5~13	130	30	52.5	56.9	—	45	—		1.5	18.0	
-160			160		75		66.4				1.7	20.0	
DN50A -DTA 7-135	1	1 ~ 7	135	21	60	37	3	38	50	—	3.4	20.1	
-165			165				33				43	3.6	20.0
-195			195				63				3.9	20.6	
-DTA12-135		2.5~13	135	30	52.5	40	7.5	45	50		3.6	21.5	
-165			165		75		15				3.8	25.8	
-195			195		45		4.2				26.4		
CT40 -DTA 3- 95	1	.02~.13	3.74	0.39	1.06	1.02	.28	.87	.98	—	2.4	4.4	
-125			4.92				1.46				2.7	4.8	
-DTA 7-102		.04~.28	4.01	0.83	1.18	1.46	.63	1.49	1.75		2.8	8.1	
-132			5.19		2.36		2.9				9.3		
-DTA12-130		.10~.51	5.11	1.18	2.08	1.57	—	1.77	3.3		11.7		
-152			5.98		2.95		.61		3.8		13.5		
CT50 -DTA 7-102	1	.04~.28	4.01	0.83	1.18	1.46	.63	1.49	2.75	—	7.1	11.8	
-132			5.19				2.36				7.3	13.0	
-152			5.98				—				.71	1.69	7.7
-203		7.87	2.71	8.6	14.0								
-DTA12-130		.10~.51	5.11	1.18	2.08	1.57	.73	1.77	—		7.7	15.6	
-152			5.98		2.95		.71				7.9	17.5	
-203	7.87		2.09		1.97		9.3			18.3			
ST16 -DTA 3	5	0.5~ 3.175	60	10	27	60	—	22	25	16	—	—	
ST20 -DTA 3	5	0.5~ 3.175	60	10	27	60	—	22	—	20	—	—	
ST32T -DTA 7- 75	6	1 ~ 7	75	21	31.5	100	—	38	—	32	—	—	
-105			105		61.5								
-DTA12-105		2.5~13	—	30	52.5	45							
-135			135		75								
S32 -DTA 7- 75	6	1 ~ 7	75	21	31.5	70	—	38	—	32	—	—	
-DTA12-100		2.5~13	100		30			52.5					45

- Option
 ●DETA-1 collet→P.31 ●Spanner→P.31 ●Retention knob (BT)→P.64
 ●Cleaning tool→P.31

- Std. Access.
 ●Coolant duct(Fixed)(HSK-A)→P.104 ●Rod(DTA3)

- Note
 ●Swing type coolant ducts are available upon request(HSK-A).
 For details, please contact us.

- Caution
 ●HSK-E and F shank don't come with a coolant duct and cannot be attached.
 ●ATC may not be possible for some machining centers with BT30-DTA12-120.
 ●For precautions and maintenance, refer to page 115.

Rod (DTA3 type)

These are necessary when attaching a collet to the holder (DTA3).

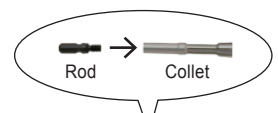
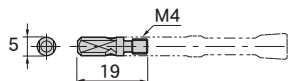

CODE	Holder type	Q'ty
PR-DTA3	DTA3	2pcs.



DETA-1 Collet Holder B type (DTB)

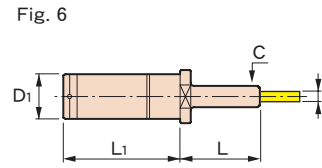
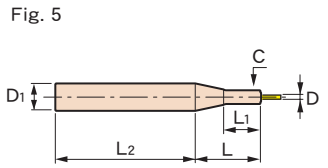
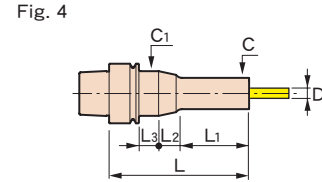
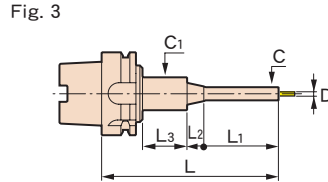
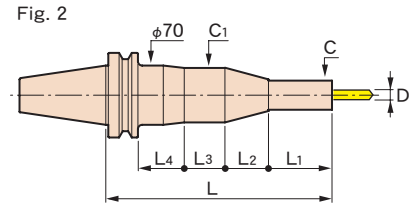
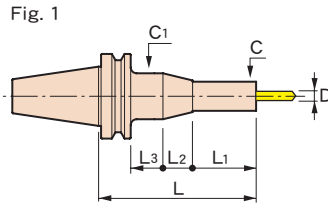
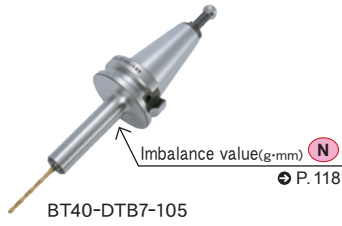

CODE	Fig.	φD	L	φC	L1	L2	L3	L4	φC1	φD1	kg	(N)	
BT30-DTB 3- 90	1	0.5 ~ 3.175	90	10	27	13	28	—	25	—	0.6	1.7	
-DTB 7- 75		1 ~ 7	75	21	53	—	—	—	—	—	0.5	2.4	
-105			105		83								3.4
-DTB12- 75		2.5 ~ 13	75	30	53								
-105			105		83							0.7	5.6
BT40-DTB 3- 80	1	0.5 ~ 3.175	80	10	27	13	13	—	25	—	1.3	2.8	
-110			110				43					1.4	3.2
-110L				57		13						1.3	2.8
-DTB 7- 60		1 ~ 7	60	21	33	—	—	—	—	—	—	1.0	3.7
-105			105		78							1.1	4.8
-135			135		75	11.8	21.2			30		1.3	5.2
-165			165		75.5	35.3	27.2			40		1.6	5.4
-195			195				57.2				1.9	5.6	
-DTB12- 90		2.5 ~ 13	90	30	63	—	—	—	—	—	—	1.2	5.3
-120			120		93							1.3	7.6
-150			150		105	11.8	6.2			40		1.5	8.4
-180			180				36.2					1.8	8.7
-210			210				66.2					2.1	8.9
BT50-DTB 7- 75		1	1 ~ 7	75	21	37	—	—	—	—	—	3.5	11.7
-105	105				67							3.7	12.3
-135	135				75	11.8	10.2			30		3.8	18.6
-195	195					58.8	23.2			50		4.6	25.0
-255	255				75.5	82.3	59.2			60		6.1	27.6
-315	2			315		75	58.8	43.7	99.5	50		7.4	33.9
-DTB12- 75	1	2.5 ~ 13	75	30	37	—	—	—	—	—	3.7	12.5	
-105			105		67							3.9	14.8
-135			135		97							4.0	15.3
-195			195		105	35.3	16.7			50		4.7	24.3
-255			255			58.8	53.2			60		5.9	28.4
-315			2	315			50.2	63				7.5	34.1
A63 -DTB 3- 75	3	0.5 ~ 3.175	75	10	27	13	4	—	25	—	0.8	6.9	
-105			105				34				0.9	7.5	
-105L				57			4					0.8	7.0

CODE	Fig.	φD	L	φC	L1	L2	L3	L4	φC1	φD1	Kg (lbs)	N		
E25 -DTB 3- 58	3	0.5~ 3.175	58	10	27	16	4.6	—	18	—	0.1	0.4		
E32 -DTB 3- 65	3	0.5~ 3.175	65	10	27	16	4.5	—	20	—	0.2	0.6		
-DTB 7- 65K	4	1 ~ 7		21	30	14.2	10.8		26		0.9			
E40 -DTB 3- 70	3	0.5~ 3.175	70	10	27	13	—	—	20	—	0.3	0.9		
-DTB 7- 95	4	1 ~ 7	95	21	50	11.8	13.2		30		0.4	1.6		
-DTB12-110		2.5~13	110	30	90	—	—		—		0.5	2.8		
E50 -DTB 3- 75	3	0.5~ 3.175	75	10	27	16	1.5	—	20	—	0.5	1.7		
-DTB 7-100	4	1 ~ 7	100	21	50	11.8	12.2		30		0.6	3.2		
-DTB12-115		2.5~13	115	30	89	—	—		—		0.8	4.2		
F63 -DTB 3- 75	3	0.5~ 3.175	75	10	27	13	4	—	25	—	0.8	2.1		
-105			105				34				0.9	2.5		
-105L			57				4				0.8	2.1		
F63M -DTB 7-100	4	1 ~ 7	100	21	50	11.8	12.2	—	30	—	0.9	3.3		
-DTB12-120		2.5~13	120	30	70	40	1.1		4.8					
DN40AD -DTB 3- 80	1	0.5~ 3.175	80	10	27	13	18.8	25	—	—	1.2	3.5		
-110			110				38.8				1.3	3.6		
-110L			57				18.8				1.2	3.9		
-DTB 7-105		1 ~ 7	105	21	74	—	12.1	—	44.45	1.1	4.8			
-135			135	75	11.8	17	30		1.2	5.0				
-DTB12-105		2.5~13	105	30	74	—	12.1	44.45	1.2	5.7				
-135			135	104	1.3	8.0								
DN50AD -DTB 7-135		1	1 ~ 7	135	21	75	11.8	13.2	15.9	30	—	3.3	14.9	
-195				195			58.8	26.2		50		4.1	21.5	
-DTB12-135	2.5~13		135	30	100	—	—	—		3.5		11.7		
-195			195	105	35.3	19.7	50	4.2		20.8				
CT40 -DTB 3- 80	1	.02~.13	3.15	.39	1.06	.51	.20	.98	—	—	2.4	3.3		
-110			4.33				1.38				2.7	3.7		
-110L			2.24				.20				2.4	3.3		
-DTB 7-105		.04~.28	4.13	.83	2.76	—	.63	—	1.75	2.4	4.6			
-135			5.31	2.95	.46	.52	1.18		2.9	5.2				
-DTB12-120		.10~.51	4.72	1.18	3.34	—	.63	1.75	1.3	7.5				
-150			5.91	3.66	.88	.62	3.5		8.5					
CT50 -DTB 7-135		1	.04~.28	5.31	.83	2.91	.46	.52	—	1.18	—	7.3	14.8	
-195	7.68			2.31			1.03	1.97		9.0		21.4		
-DTB12-135	.10~.51		5.31	1.18	3.94	—	.63	2.75		7.7		11.6		
-195			7.68	4.13	1.39	.78	1.97	9.0		20.8				
ST12 -DTB 3			5	0.5~ 3.175	29	10	25	61		—		—	—	12
ST16 -DTB 3	5	0.5~ 3.175	38.5	10	27	81.5	—	—	—	16	—			
ST20 -DTB 3	5	0.5~ 3.175	48	10	27	102	—	—	—	20	—			
ST25T -DTB 7- 15	6	1 ~ 7	15	21	110	—	—	—	—	25	—	—		
- 45			45										—	—
- 75			75										—	—
ST32T -DTB 7- 15	6	1 ~ 7	15	21	92	—	—	—	—	32	—	—		
- 45			45										—	—
- 75			75										—	—
-DTB12- 15		2.5~13	15	30	—	—	—	—	—	—	—	—		
- 45			45										—	—
- 75			75										—	—
S32 -DTB 7- 15	6	1 ~ 7	15	21	70	—	—	—	—	32	—	—		
-DTB12- 40		2.5~13	40										30	—

- Option
•DETa-1 collet→P.31 •Wrench→P.31 •Retention knob (BT)→P.64
•Cleaning tool→P.31
- Std. Access.
•Coolant duct(Fixed)(HSK-A)→P.104
- Note
•Swing type coolant ducts are available upon request(HSK-A).
For details, please contact us.
•BT30-DTB12 requires the dedicated retention knob, which has the feature of draw bolt. Please choose P-538 or P-535.
- Caution
•For the E32-DTB7-65K, collet collapsibility is not available. The clamping diameter applies only to nominal end-mill shank size.
•HSK-E shank doesn't come with a coolant duct and cannot be attached.
•For precautions and maintenance, refer to page 115.

Retention knob for BT30-DTB12

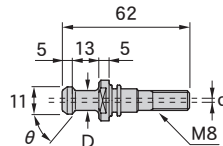

CODE	φD	φd	θ	Note
P-538	8	4	45	In accordance with MAS-1
-535	7.5	2.5	60	In accordance with MAS-2



DETa-1 Collet Holder E type (DTE)



Imbalance value(g·mm) **N**
 P.118

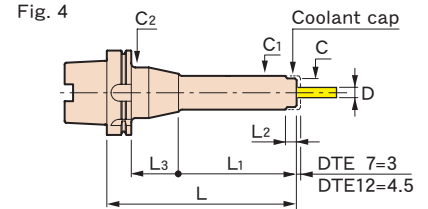
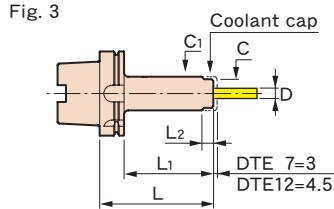
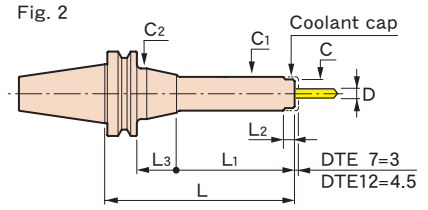
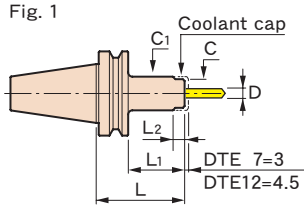

CODE	Fig.	φD	L	φC	L1	L2	L3	φC1	φC2	KG	N
BT30-DTE 7- 60-MAS1	1	1 ~ 7	60	24	38	11.5	—	29	—	0.6	3.2
-MAS2		2.5~ 13	75	34	53	14	—	40	—	0.9	4.9
-DTE12- 75-MAS1											
-MAS2											
BT40-DTE 7- 90	1	1 ~ 7	90	24	63	11.5	—	29	—	1.3	4.9
-120	2		120		70		23		40	1.5	6.2
-150			150				53		50	1.9	7.2
-180			180				83			2.4	8.9
-210			210				113			2.9	9.8
-DTE12- 90	1		2.5~ 13		90		34		63	14	—
-120		120		93				1.8	7.4		
-150		150		123				2.1	9.4		
-180	2	180		140	13	50		2.5	9.6		
-210		210			43			2.9	11.7		
-DTE12-105	1	2.5~ 13		105	34	67		14	—		40
-135			135	97					4.5	18.9	
-165			165	127					4.8	21.0	
-225	2		225	140		47	60		5.7	24.5	
-285			285			107	70		7.6	27.1	
-DTE12-105	1		2.5~ 13	105		34	67		14	—	
-135		135		97				4.5		18.9	
-165		165		127				4.8		21.0	
-225	2	225		140	47		60	5.7		24.5	
-285		285			107		70	7.6		27.1	
A40 -DTE 7- 95	3	1 ~ 7		95	24		75	11.5		—	29
-DTE12-105		2.5~ 13	105	34	85	14	—	40	—	0.9	14.4
A50 -DTE 7-105	3	1 ~ 7	105	24	79	11.5	—	29	—	0.7	9.8
-DTE12-120		2.5~ 13	120	34	94	14	—	40	—	1.1	12.5
A63 -DTE 7-105	4	1 ~ 7	105	24	70	11.5	9	29	40	1.1	12.3
-120			24						1.2	12.8	
-150			54				50		1.7	14.3	
-180			84						2.1	15.7	
-DTE12-120			3				2.5~ 13		120	34	94
-150		150	124			1.8		16.0			
-180	4	180	140	14	50	2.3		19.1			
A100-DTE 7-135	4	1 ~ 7	135	24	70	11.5	36	29	40	2.7	31.0
-165			66				50		3.2	32.4	
-225			126				60		4.7	35.7	
-DTE12-135	3	2.5~ 13	135	34	106	14	—	40	—	3.0	33.1
-165			136				3.3		36.2		
-225			4		225		140		56	60	4.4

CODE	Fig.	φD	L	φC	L1	L2	L3	φC1	φC2	KG (lbs)	N
DN40AD-DTE 7- 90 -120 -DTE12- 90 -150	2	1 ~ 7	90	24	58	11.5	12.9	29	45	1.2	5.4
			120		70		30.9				
		2.5~13	90	34	58.8	14	12.1	40	1.3	6.1	
			150		118.8		1.9				9.3
DN50AD-DTE 7-105 -165 -DTE12-105 -165	2	1 ~ 7	105	24	70	11.5	15.9	29	70	3.4	12.0
			165		60		50		4.2		
		2.5~13	105	34	14	15.9	40	70	3.6	12.6	
			165		130		4.2		17.0		
CT40-DTE 7- 90 -120 -DTE12- 90 -150	2	.04~.28	3.54	.94	2.17	.45	.63	1.14	1.75	2.7	5.2
			4.72		2.75		1.22				
		.10~.51	3.54	1.34	2.17	.55	.63	1.57	1.75	3.1	6.1
			5.91		4.53		4.2				
CT50-DTE 7-105 -165 -DTE12-105 -165	2	.04~.28	4.13	.94	2.75	.45	.63	1.14	2.75	7.5	11.8
			6.5		2.36		1.97		9.0		
		.10~.51	4.13	1.34	2.75	.55	.63	1.57	2.75	7.9	12.9
			6.5		5.12		9.3				

Option

- DETa-1 collet → P.31 • Wrench → P.31 • Retention knob (BT40/50) → P.64
- Tap rod (DTE12) → P.30 • Spacer • Coolant cap
- Spacer set • Coolant-through system

Std. Access.

- Coolant duct (Fixed) (HSK-A) → P.104 • Retention knob (BT30)

Note

- Swing type coolant ducts are available upon request (HSK-A). For details, please contact us.

Caution

- A dedicated retention knob is supplied with the BT30-DTE as a standard accessory. When ordering, specify whether a MAS-1 or MAS-2 retention knob is required. To replace the retention knob, please contact us.
- For precautions and maintenance, refer to page 115.

Cutting data

DTA type

<p>S50C</p> <p>φ3 Carbide drill 3 flutes</p> <p>n 9000 min⁻¹ Vf 900 mm/min Vc 85 m/min f 0.1 mm/rev</p> <p>E32-DTA3-75</p>	<p>S50C</p> <p>φ3 Carbide Square endmill 3 flutes</p> <p>n 6000 min⁻¹ Vf 150 mm/min Vc 60 m/min fz 0.013 mm/t</p> <p>E32-DTA3-75</p>	<p>Aluminum</p> <p>φ8.5 Carbide drill</p> <p>n 10000 min⁻¹ Vf 5000 mm/min Vc 267 m/min f 0.5 mm/rev</p> <p>BT40-DTA12-165</p>
--	--	---

DTB type

<p>A6061</p> <p>φ0.8 Straight drill</p> <p>n 6000 min⁻¹ Vf 60 mm/min Vc 15 m/min</p> <p>BT40-DTB3-110L</p>	<p>A5052</p> <p>φ0.8 Straight drill</p> <p>n 10000 min⁻¹ Vf 400 mm/min Vc 25 m/min</p> <p>※234 pcs.</p> <p>A63-DTB3-75</p>	<p>S50C</p> <p>R1.5 Carbide ball endmill</p> <p>n 12500 min⁻¹ Vf 1560 mm/min Vc 120 m/min f 0.125 mm/rev</p> <p>E32-DTB3-65</p>	<p>S50C</p> <p>φ3 Carbide Square endmill 2 flutes</p> <p>n 6000 min⁻¹ Vf 150 mm/min Vc 60 m/min fz 0.013 mm/t</p> <p>E32-DTB3-65</p>
--	--	---	--

<p>S50C</p> <p>R1.5 Carbide ball endmill</p> <p>n 12500 min⁻¹ Vf 1560 mm/min Vc 120 m/min f 0.125 mm/rev</p> <p>E32-DTB3-65</p>	<p>STAVAX(42HRC)</p> <p>φ0.6 Carbide straight drill</p> <p>n 3715 min⁻¹ Vf 30 mm/min Vc 7 m/min f 0.01 mm/rev</p> <p>F63-DTB3-75</p>	<p>SKD61(46HRC)</p> <p>R3 Carbide ball endmill 2 flutes</p> <p>n 5000 min⁻¹ Vf 1500 mm/min Vc 94 m/min fz 0.15 mm/t</p> <p>BT40-DTB7-105</p>	<p>SKD61(46HRC)</p> <p>φ10 Carbide endmill 2 flutes</p> <p>n 4500 min⁻¹ Vf 1500 mm/min Vc 141 m/min fz 0.17 mm/t</p> <p>BT40-DTB12-90</p>
---	--	--	---

DTE type

<p>S50C</p> <p>φ6 Carbide drill</p> <p>n 6369 min⁻¹ Vf 1592 mm/min Vc 120 m/min f 0.25 mm/rev</p> <p>A63-DTE7-105</p>	<p>SKD61(53HRC)</p> <p>R5 Carbide ball endmill 2 flutes</p> <p>n 20000 min⁻¹ Vf 6000 mm/min Vc 628 m/min fz 0.15 mm/t</p> <p>A63-DTE12-120</p>
---	--

Tap rod (DTE12type)

To be used as a stopper for synchronized tapping.

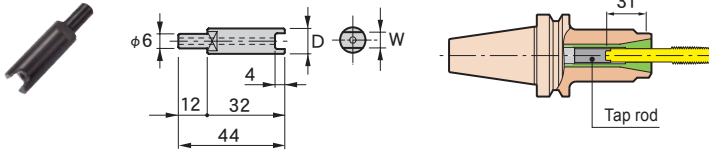

CODE	Applicable taps	φD	W	Collet
TR-5	JIS M 8	10.5	5	D12-12
-5.5	JIS M10		5.5	
-6	OSG M 8 M10	12	6	-13
-6.5	JIS M12		6.5	
-8	OSG M12	12	8	

COOLANT-THROUGH SYSTEM (OPTION)

Spacer

EA type

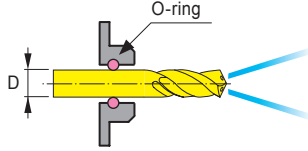

EBM type (Groove-type)

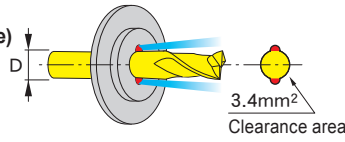

CODE	Holder type	φD	Q'ty
7EA- 3.5-3	DTE 7	3 ~ 3.5	3pcs.
- 4 -3		3.5 ~ 4	1set
- 4.5-3		4 ~ 4.5	
- 5 -3		4.5 ~ 5	
- 5.5-3		5 ~ 5.5	
- 6 -3		5.5 ~ 6	
- 6.5-3		6 ~ 6.5	
- 7 -3		6.5 ~ 7	
12EA- 3.5-3	DTE12	3 ~ 3.5	3pcs.
- 4 -3		3.5 ~ 4	1set
- 4.5-3		4 ~ 4.5	
- 5 -3		4.5 ~ 5	
- 5.5-3		5 ~ 5.5	
- 6 -3		5.5 ~ 6	
- 6.5-3		6 ~ 6.5	
- 7 -3		6.5 ~ 7	
- 8 -3		7 ~ 8	
- 9 -3		8 ~ 9	
-10 -3		9 ~ 10	
-11 -3		10 ~ 11	
-12 -3		11 ~ 12	
-13 -3	12 ~ 13		

CODE	Holder type	φD	Q'ty
7EBM- 3-3	DTE 7	3	3pcs.
- 4-3		4	1set
- 6-3		6	
12EBM- 3-3	DTE12	3	3pcs.
- 4-3		4	1set
- 6-3		6	
- 8-3		8	
-10-3		10	
-12-3		12	

EBS type (Round-type)

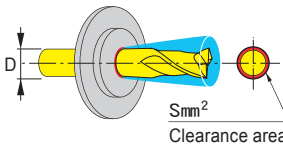

CODE	Holder type	φD	S	Q'ty
7EBS- 3.6-3	DTE 7	3	3.1	3pcs.
- 4.5-3		4	3.3	1set
- 6.4-3		6	3.9	
12EBS- 3.6-3	DTE12	3	3.1	3pcs.
- 4.5-3		4	3.3	1set
- 6.4-3		6	3.9	
- 8.4-3		8	4.6	
-10.3-3		10	4.8	
-12.3-3		12		

Spacer blank type

Depend on cutter or application, please modify.



CODE	Holder type	Q'ty
7EBF-BL-5	DTE 7	5pcs.
12EBF-BL-5	DTE12	1set

Spacer set

CODE	Holder type	Contents of set		
		Spacer	Q'ty	Coolant cap
7ES-A	DTE 7	7EA -3.5~7	(1ea.)	CLP- 7E
		7EBM-3, 4, 6	total	
		7EBS-3.6, 4.5, 6.4	14pcs.	
12ES-A	DTE12	12EA -3.5~13	(1ea.)	CLP-12E
		12EBM-3~12	total	
		12EBS-3.6~12.3	26pcs.	



■ Std. Access.
● Collet driver

Coolant cap

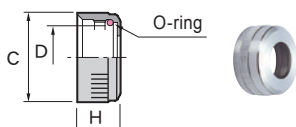

CODE	Holder type	φD	φC	H
CLP- 7E	DTE 7	21	29	14
-12E	DTE12	30	40	18

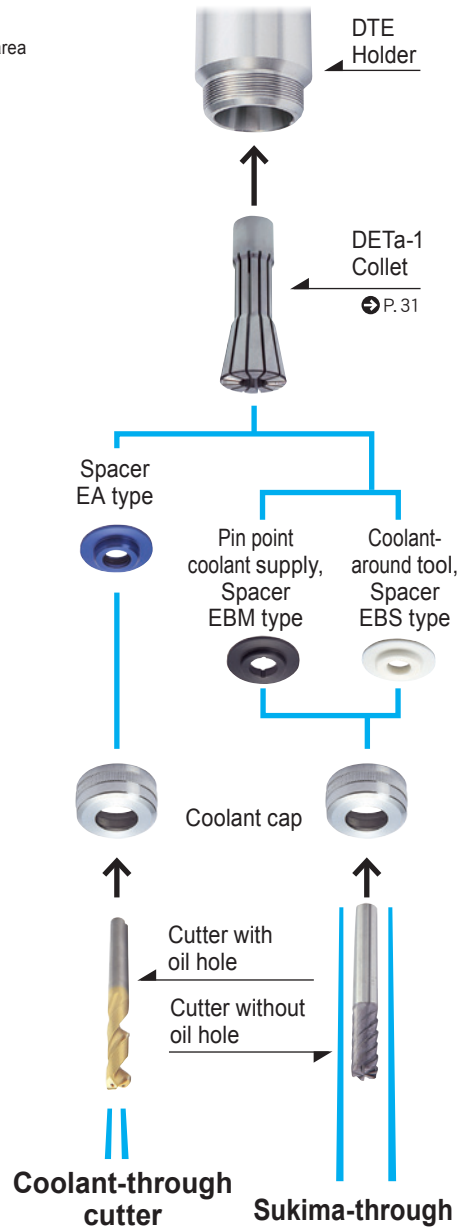

DETa-1 COLLET

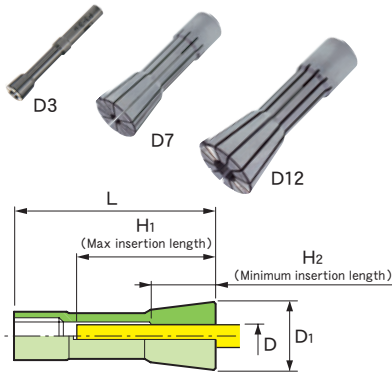

Highest guaranteed accuracies throughout entire chucking range(100% inspection)

Collet	Run-out accuracy(μm)	
	D3	D7/D12
Precision Collet	3 (6)	5 (10)
Standard Collet	5 (10)	10 (15)

※Accuracy of collet alone, () means collapsibility usable.

D	L
~10	4×D
10~13	40

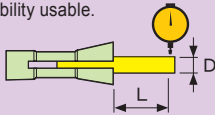

CODE		ϕD	Holder type	Collap-sibility	ϕD_1	L	H1	H2						
Standard Collet	Precision Collet													
D 3- 0.6 - 0.8 - 1 - 1.5 - 2 - 2.5 - 3 - 3.175	Add "-P" after the standard type item code. < Example > D12 - 6 - P	0.5 ~ 0.6	DTA 3 DTB 3	0.1	7	40	30	6.9						
		0.6 ~ 0.8												
		0.8 ~ 1												
		1 ~ 1.5												
		1.5 ~ 2												
		2 ~ 2.5												
		2.5 ~ 3												
		2.7 ~ 3.175												
		1 ~ 1.5												
		1.5 ~ 2												
2 ~ 2.5														
2.5 ~ 3														
3 ~ 4														
4 ~ 5														
5 ~ 6														
6 ~ 7														
D12- 4 - 6 - 8 -10 -12 -13		2.5 ~ 4	DTA12 DTB12 DTE12	1.5	26	70	50	16						
		4 ~ 6												
		6 ~ 8												
		8 ~ 10												
		10 ~ 12												
		11 ~ 13												
		1 ~ 1.5							DTA 7 DTB 7 DTE 7	0.5	17	50	36	7
		1.5 ~ 2												
		2 ~ 2.5												
		2.5 ~ 3												
3 ~ 4														
4 ~ 5														
5 ~ 6														
6 ~ 7														
1		2	26	70	50	20								
2														
3														
4														
5														
6														
7														
8														
9														
10														
11														

Spanner · Wrench

CODE	Holder type	Fig.	B	R	L	Tightening torque (N·m)
F- 22	DTA 3	1	-	22	110	2~ 3
DW-2.5-110	DTB 3	2	2.5	-		
F- 38	DTA 7	3	-	19	148.5	20~40
- 45	DTA12			22.5	225	70
TW-4	E32 - DTB 7	4	4	-	77	14
-5	DTB 7				153	
-6	DTB12				173	34
W-135DR	DTE 7	5	5		110	14
	DTE12				18	
	E40 - DTB12					
	E50 - DTB12					
	F63 - DTB 7					14
	F63 - DTB12					18

■Std. Access.

- Collet driver (F-38, F-45, TW-5, TW-6, W135-DR)

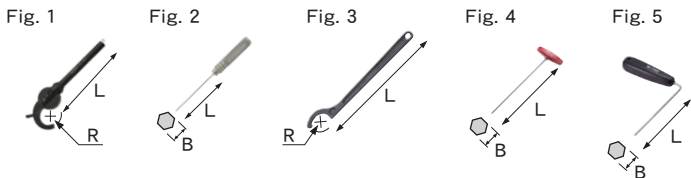

Adjustable torque wrench

The nut-tightening torque can be adjusted more properly.

Spanner for torque wrench	Adjustable torque wrench	Holder type
F-38AW	AW-1	DTA 7
-45AW		DTA12

Attaching a cutting tool (DTB, DTE)

If a retention knob with a hole is used, direct tightening of cutting tools is possible.

Required hole dia of retention knob

- DTB 3 : $\phi 4 \sim$
- DTB 7, DTE : $\phi 6 \sim$
- DTB12 : $\phi 7 \sim$



Collet driver

The DETA-1 collet can be attached/detached with ease.

CODE	Q'ty
DR-1	2pcs.

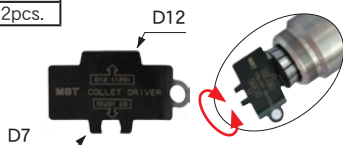

Cleaning tool felt type

Apply this tool to clean the hard-to-clean inside portion of DTA3 and DTB3 holders. The initial accuracy of tool holders can be made to last a long time by keeping the internal bore clean.

CODE	Q'ty
PCT01-10	10 pcs.
-25	25 pcs.

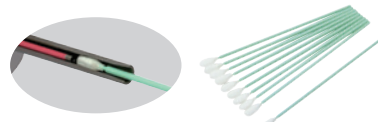

The optimum holder choices for a variety of applications!!



CTA



CTH
For high-speed

Coolant-through



Coolant-Through Cutter
"SUKIMA" Coolant Around Tool
Coolant-Through Collet

Precision spring collet

The increased number of slits ensures the uniform tightening and high accuracy of the collet.

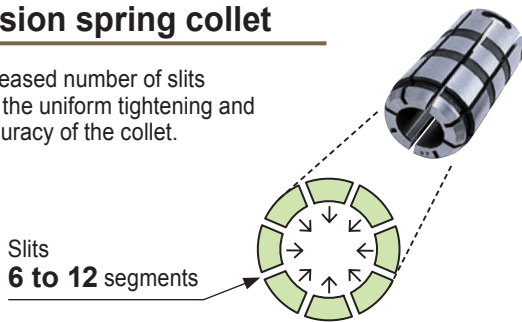

Using a high-precision collet will increase the life of your tools. P. 117

Highest guaranteed accuracies throughout entire chucking range (100% inspection)

Collet	Run-out accuracy(μm)
Precision Collet	5
Standard Collet	10

※Accuracy of collet alone

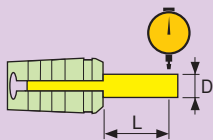

D	L
~10	4×D
10 ~20	40
20.5~42	60

Ideal taper angle

Since the collet angle is smaller than that of typical collets, the collapsibility is also small. However, because the collet can be inserted deeper into the main body, the gripping area increases, it provides stable run-out accuracy and high gripping force and rigidity for end milling. This collet as a taper angle of 6°, the ideal angle for run-out accuracy, gripping force and rigidity.

MST

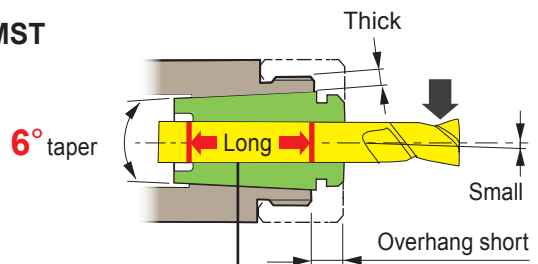

True clamping length

When the taper angle decreases, the collapsibility decreases; however, the true clamping length increases.

Others

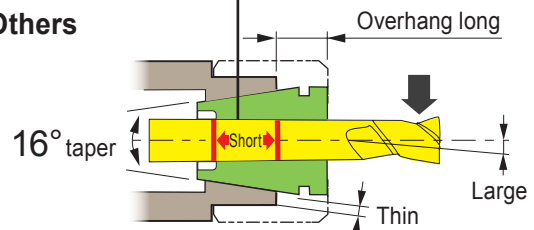

Thick and highly rigid body

- Thick body.
- The nut part is compact and has less interference.
- Short holder length.

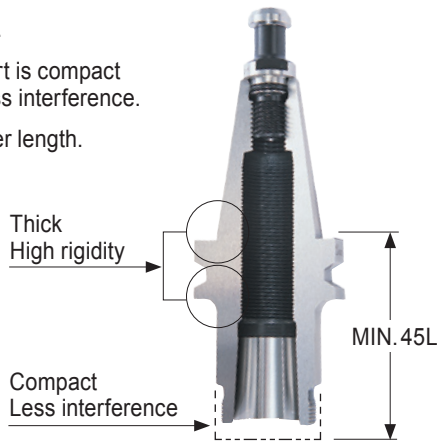

Nut for high accuracy

- Because steel ball bearings are built into the nut, the collet does not get twisted when tightened.
- The threaded area and the ball bearing grooves for steel bearings are finished using the same process after heat treatment, thus providing high accuracy with no distortion.
- Stable tightening force and smoothly rotation achieve high accuracy.

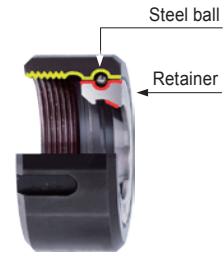

Five main body types based on cutting tool size

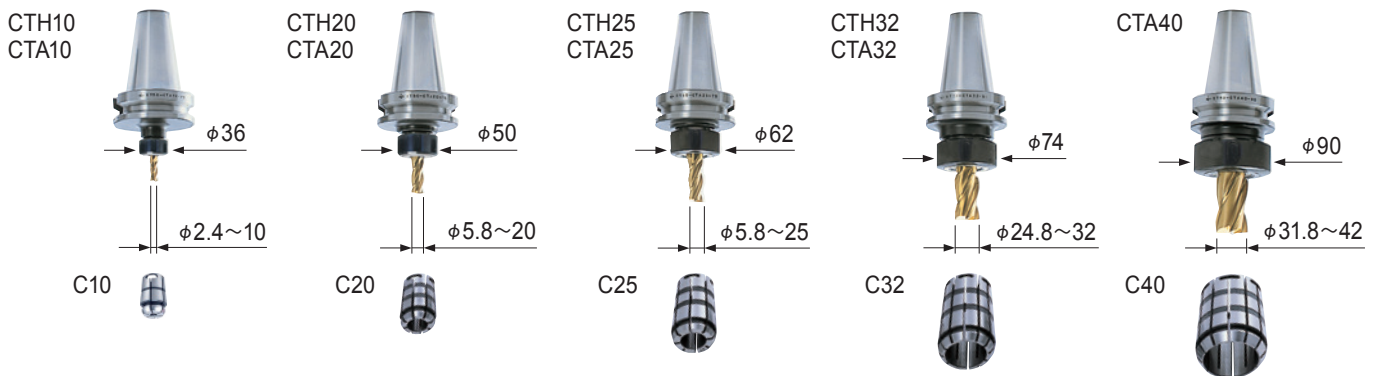

A variety of holder lengths 45L~315L

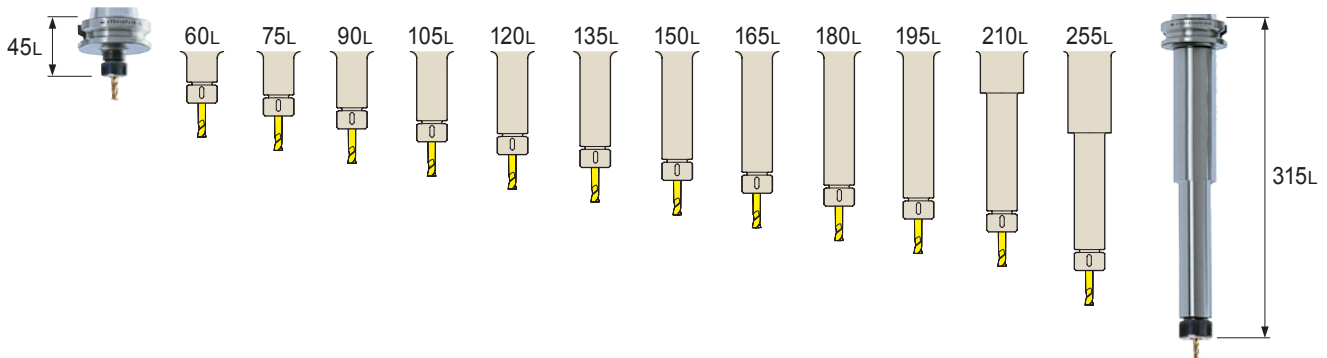

Pre-balanced by previously designing (CTH_{type})

The collet holder (CTH type) is pre-balanced by previously designing the holder to be as axisymmetrical as possible. When used with the precision collet, it enables stable machining during high-speed machining.

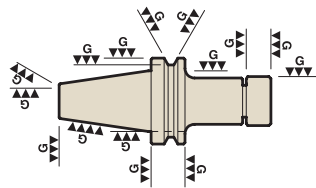

Comparison in imbalance value

Holder code	Spring collet used	Cutter used		Imbalance value (g·mm)
		Diameter	Overhang	
BT30-CTH10-75	Precision collet C10-10-P	φ10	40	3.3
-CTA10-75	Standard collet C10-10			13.1

Longer cutter life using through-spindle capability
➔ P. 117

Coolant-through system

The spindle-through feature can be used whether the cutting tool has oil holes or not. ➔ P. 39

Pressure
7 Mpa

Coolant-Through
Cutter

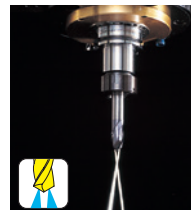

“SUKIMA”
Coolant Around Tool



Coolant-Through
Collet



COLLET HOLDER for high-speed (CTH)

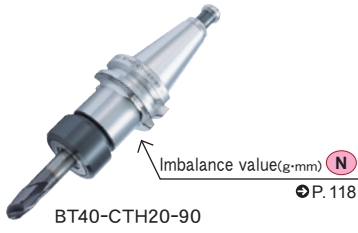





BT40-CTH20-90

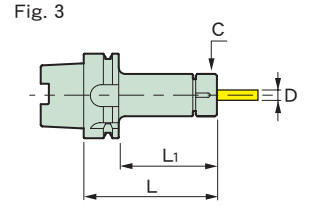
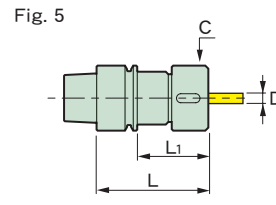
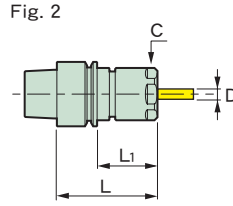
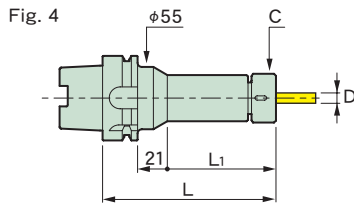
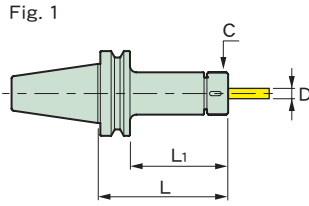

A63-CTH20-90



CODE	Fig.	φD	L	φC	L ₁	Kg	N
BT30-CTH10- 45	1	2.4~10	45	36	23	0.5	2.6
- 75			75		53	0.6	2.7
-CTH20- 60		5.8~20	60	50	38	0.9	4.3
- 90			90		68		4.7
BT40-CTH10- 60	1	2.4~10	60	36	33	1.1	3.8
- 90			90		63	1.3	4.0
-120			120		93	1.4	4.4
-150			150		123	1.6	4.6
-CTH20- 60		5.8~20	60	50	33	1.2	6.4
- 90			90		63	1.4	7.0
-120			120		93	1.7	7.3
-150			150		123	2.0	7.6
-CTH25- 75		5.8~25	75	62	48	1.5	8.9
-105			105		78	2.0	9.8
BT50-CTH10-105	1	2.4~10	105	36	67	3.8	5.3
-135			135		97	4.0	5.7
-165			165		127	4.1	6.1
-CTH20-105		5.8~20	105	50	67	4.2	8.3
-135			135		97	4.6	9.0
-165			165		127	4.9	9.4
-CTH25- 75		5.8~25	75	62	37	3.8	10.3
-105			105		67	4.4	11.0
-CTH32- 90		24.8~32	90	74	52	4.1	14.4
A40 -CTH10- 55		3	2.4~10	55	32	35	0.4
- 75	75			55		0.5	3.9
- 90	90			70		0.6	4.0
-CTH20- 75	5.8~20		75	50	55	0.7	7.3
- 90			90		70	0.8	7.0
-CTH25- 95	5.8~25		95	55	75	0.9	10.7
A50 -CTH10- 55	3	2.4~10	55	36	29	0.6	6.6
- 75			75		49	0.7	6.9
A50M-CTH20- 80*		5.8~20	80	50	54	0.9	10.2
-105*			105		79	1.2	11.1
-CTH25-105*		5.8~25		62		1.3	14.7

CODE	Fig.	φD	L	φC	L ₁		
A63 -CTH10- 75	3	2.4~10	75	36	49	0.9	10.2
- 90			90		64	1.0	10.4
-120			120		94	1.2	10.7
-150			150		124	1.4	11.0
-CTH20- 90		5.8~20	90	50	64	1.2	14.1
-120			120		94	1.5	14.0
-150			150		124	1.9	14.9
-CTH25-105		5.8~25	105	62	79	1.6	17.1
A100 -CTH10-135	3	2.4~10	135	36	106	2.7	25.1
-165			165		136	2.9	25.4
-225			225		175	3.4	26.0
-CTH20-135	3	5.8~20	135	50	106	3.2	28.5
-165			165		136	3.6	29.5
-225			225		196	4.3	31.1
-CTH25-135	5.8~25	135	62	106	3.7	31.4	
-165		165		136	4.3	32.7	
-195		195		166	4.8	34.1	
E32 -CTH10- 55	5	2.4~10	55	32	35	0.2	1.2
-CTS10- 50※	2		50				26
E40 -CTH10- 55	5	2.4~10	55	32	34	0.4	1.4
E50 -CTH10- 60	5	2.4~10	60	36	34	0.7	2.1
- 90			90		64	0.9	2.3
-CTH20- 75		5.8~20	75	50	49		3.8
F63 -CTH10- 60	5	2.4~10	60	36	34	0.9	2.2
- 90			90		64	1.1	2.4
-CTH20- 75		5.8~20	75	50	49		3.9
DN40AD -CTH20- 75	1	5.8~20	75	50	56	1.1	5.4
-135			135		116	1.7	5.9
 -CTH25- 75※		5.8~25	75	62	56	1.4	7.2
DN50AD -CTH20-105	1	5.8~20	105	50	70	3.6	9.1
-165			165		130	4.4	9.9
 -CTH25-105		5.8~25	105	62	70	3.8	10.9

■ Option

- Spring collet(Precison collet)→P.38 • Spanner→P.38 • Adjust screw→P.37
- Retention knob (BT)→P.64 • Adjustable torque wrench→P.38
- Coolant screw→P.39 • Sukima nut→P.39 • Collet remover→P.38

■ Std. Access.

- Nut (NUA-CTH)→P.37 • Coolant duct(Fixed) (HSK-A)→P.104

■ Note

- Swing type coolant ducts are available upon request (HSK-A). For details, please contact us.
- Applicable for coolant-through methods →P.39
- Be sure to use precision-type spring collet.

■ Caution

- ※ The undercut area of the A50M and DN40AD-CTH25 are different from the standards. Please be careful to check for interference with the ATC arm.
- ※ CTS10 = Collapsibility cannot be used. The collet can only chuck a tool of the reference diameter.
- HSK-E and F shank don't come with a coolant duct and cannot be attached.
- For precautions and maintenance, refer to page 116.

COLLET HOLDER(CTA)



BT50-CTA20-135



ST32T-CTA20-90

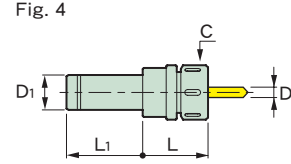
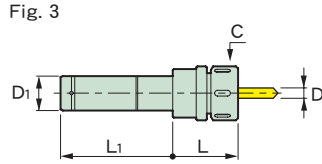
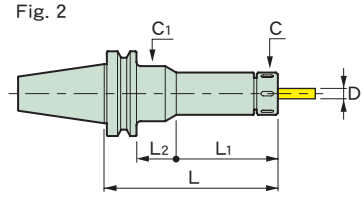
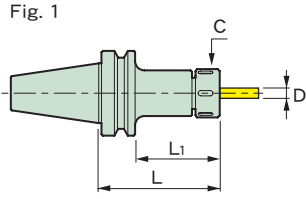

CODE	Fig.	ϕD	L	ϕC	L ₁	L ₂	ϕC_1	Kg	
BT30-CTA10- 45	1	2.4~10	45	36	23	—	—	0.5	
- 75			75		53			0.7	
-105			105		83			0.9	
-CTA20- 60		1	5.8~20	60	50	38	—	—	0.6
- 90	90			68		0.9			
BT40-CTA10- 60	1	2.4~10	60	36	33	—	—	1.1	
- 90			90		63			1.3	
-120			120		93			1.5	
-150			150		123			1.7	
-180			180		153			1.9	
-210			210		155			2.1	
-CTA20- 60			1		5.8~20			60	50
- 90	90	63		1.4					
-120	120	93		1.7					
-150	150	123		2.1					
-180	180	153		2.5					
-210	210	183		2.9					
-CTA25- 75	1	5.8~25		75	62	48	—	—	1.2
-105				105		78			1.6
-135				135		108			2.0
-CTA32-105	1	24.8~32		105	74	78	—	—	1.8
BT50-CTA10-105	1	2.4~10	105	36	67	—	—	3.8	
-135			135		97			3.9	
-165			165		127			4.0	
-195			195		157			4.2	
-255			255		155			4.9	
-CTA20-105	1	5.8~20	105	50	67	—	—	4.0	
-135			135		97			4.4	
-CTA20-105	2	5.8~20	165	50	127	—	—	4.8	
-195			195		157			5.2	
-255			255		180			6.3	
-315			315		122			7.7	
-CTA25- 75	1	5.8~25	75	62	37	—	—	3.6	
-105			105		67			4.2	
-135			135		97			4.8	
-165			165		127			5.4	
-195			195		157			6.0	
-255			255		217			7.2	
-CTA32- 90	1	24.8~32	90	74	52	—	—	4.0	
-120			120		82			4.7	
-CTA40- 90	1	31.8~42	150	90	112	—	—	5.4	
-180			180		142			6.1	
-120			120		82			5.0	

CODE	Fig.	φD	L	φC	L ₁	φD ₁	G	Kg (lbs)
DN40AD-CTA20- 75	1	5.8~20	75	50	56	—	—	1.1
-135			135		116			1.9
-CTA25- 75		5.8~25	75	62	56			1.7
DN50AD-CTA20-105	2	5.8~20	105	50	70	—	—	2.3
-165			165		130			3.0
-CTA25-105		5.8~25	105	62	70			2.9
CT40 -CTA20- 75	1	.23~.79	2.95	1.97	2.20	—	—	2.65
-135			5.31		4.57			3.75
-CTA25- 75		.23~.98	2.95	2.44	2.20			3.09
CT50 -CTA20-105	1	.23~.79	4.13	1.97	2.68	—	—	7.94
-165			6.50		5.12			9.70
-CTA25-105		.23~.98	4.13	2.44	2.68			8.60
ST20T-CTA10	3	2.4~10	35	36	110	20	—	—
ST25T-CTA10	3	2.4~10	35	36	110	25	—	—
-CTA20			60	50				
ST32T-CTA10- 30	3	2.4~10	30	36	100	32	—	—
- 60			60					
- 90			90					
-120			120					
-CTA20- 60		5.8~20	60	50				
- 90			90					
-120	120							
ST42T-CTA25- 90	3	5.8~25	90	62	110	42	—	—
-120			120					
S 32 -CTA10	4	2.4~10	30	36	70	32	—	—
-CTA20		5.8~20	60	50				
S 42 -CTA10	4	2.4~10	30	36	80	42	—	—
-CTA20		5.8~20	35	50				
-CTA25		5.8~25	80	62				

- **Option**
- Spring collet→P.38
 - Spanner→P.38
 - Retention knob(BT)→P.64
 - Adjustable torque wrench→P.38
- **Std. Access.**
- Nut(NUA-CTA)

- **Note**
- Applicable for coolant-through methods. Please contact us for more information.
- **Caution**
- The undercut area of the DN40AD-CTA25 and CT40-CTA25 are different from the standard. Please be careful to check for interference with the ATC arm.
 - For precautions and maintenance, refer to page 116.

Nut

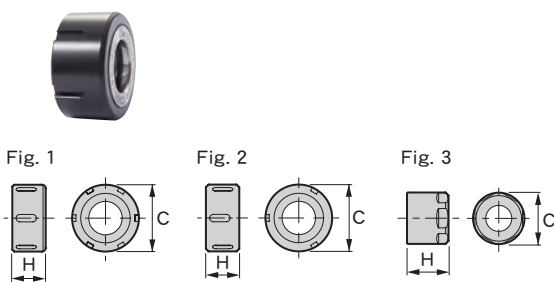

CODE	Fig.	φC	H	Holder type
NUA-CTA10	1	36	18	CTA10
-CTA20		50	25	CTA20
-CTA25		62	28.5	CTA25
-CTA32		74	32	CTA32
-CTA40		90	36	CTA40
-CTH10	2	36	18	CTH10
-CTH20		50	25	CTH20
-CTH25		62	28.5	CTH25
-CTH25-55		55		CTH25(A40)
-CTH32		74	32	CTH32
-CTH10-32	3	32	18	CTH10(A40, E32, E40)
-CTS10		26	21	CTS10

Adjust screw

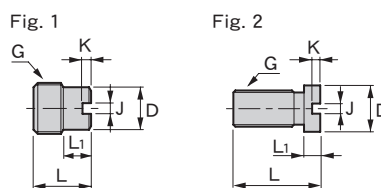

The overhang of the cutting tool can be adjusted.

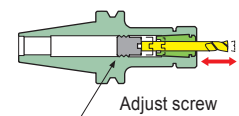

CODE	Fig.	L	φD	L ₁	J	K	G	Holder type
AJC-M14	1	22	10	8	1.5	3	M14×1.5	CTA10
ST25T-CTA20								
-M24		27	20	13	5	4	M24×1.5	CTA20 (※1)
BT40-CTA25- 75								
-M28	24	15	8			M18×1.5	CTA25 (※2)	
-M18							BT30-CTA20 ,	
-M18L	2	43	23					BT50-CTA32 , CTA40

※1 : Except BT30, SE30M, ST25T and ST32T
 ※2 : Except BT40-CTA25-75

SPRING COLLET

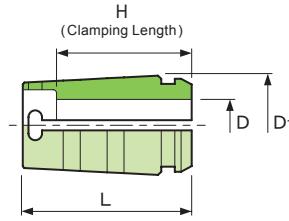

CODE		φD	Holder type	Collapsibility	L	φD1	H
Standard Collet	Precision Collet						
C10-D		2.6 2.8 3 3.2 3.4 3.6 3.8 4 4.2 4.4	CTH10 CTA10 CTS10*	0.2	26	17.2	D=2.6~5(Except 3,4) → 16
		4.6 4.8 5 5.2 5.4 5.6 5.8 6 6.2 6.4					3, 4, 5.2 ~ 5.8 → 18
		6.6 6.8 7 7.2 7.4 7.6 7.8 8 8.2 8.4					6 ~ 10 → 20
		8.6 8.8 9 9.2 9.4 9.6 9.8 10					
C20-D	Add "-P" after the standard type item code. (Example) C10 - 6 - P	6 6.2 6.4 6.6 6.8 7 7.2 7.4 7.6 7.8 8	CTH20 CTA20	0.2	50	29.5	D= 6 ~ 9.8 → 32
		8.2 8.4 8.6 8.8 9 9.2 9.4 9.6 9.8 10					10 ~ 15.8 → 35
		10.2 10.4 10.6 10.8 11 11.2 11.4 11.6					16 ~ 20 → 40
		11.8 12 12.2 12.4 12.6 12.8 13 13.2					
		13.4 13.6 13.8 14 14.2 14.4 14.6 14.8					
		15 15.2 15.4 15.6 15.8 16 16.2 16.4					
		16.6 16.8 17 17.2 17.4 17.6 17.8 18					
		18.2 18.4 18.6 18.8 19 19.2 19.4 19.6					
		19.8 20					
		C25-D					
14 14.5 15 15.5 16 16.5 17 17.5 18	10 ~ 15 → 48						
18.5 19 19.5 20 20.5 21 21.5 22 22.5	15.5 ~ 20 → 54						
23 23.5 24 24.5 25	20.5 ~ 25 → 57						
C32-D		25 28 30 32	CTH32 CTA32	0.2	80	46	D=25 ~ 28 → 66
							30 ~ 32 → 68
C40-D		32 40 42	CTA40	0.2	80	56	D=32 ~ 40 → 65
							42 → 70

CODE	φD	Holder type	Collapsibility	L	φD1	H
C20-D	1/4 5/16 3/8	CTA20	.008	1.97	1.16	1.14
	7/16 1/2					1.30
	5/8 3/4					1.57
C25-D	1/4 5/16 3/8	CTA25	.008	2.67	1.44	1.38
	7/16 1/2					1.81
	5/8 3/4					2.12
	1IN					2.24

Ex. C10 - 6 - P

- Option
 - Collet remover
- Note
 - Please contact us if you need a size that is not mentioned above, and we will manufacture it for you (standard accuracy collets only).
- Caution
 - *CTS10 = Collapsibility cannot be used. The collet can only chuck a tool of the reference diameter.

Spanner · Wrench



CODE	Fig.	Holder type	R	L	Tightening torque(N·m)
FC-32	1	CTH10 (A40, E32, E40)	16	120	40~60
-36		CTA10, CTH10	18	208	
-50		CTA20, CTH20	25	281	120
-55		CTH25(A40)	27.5	284	150
-62		CTA25, CTH25	31	312	
-74		CTA32, CTH32	37	364	
-90		CTA40	45		
RC-26	2	CTS10	-	240	-

Adjustable torque wrench

The nut-tightening torque can be adjusted more properly.

Spanner for torque wrench	Adjustable torque wrench	Holder type
FC-36AW	AW-1	CTA10, CTH10
-50AW	-2	CTA20, CTH20

Highest guaranteed accuracies throughout entire chucking range(100% inspection)

Collet	Run-out accuracy (μm)
Precision Collet	5
Standard Collet	10

※Accuracy of collet alone

D	L
~10	4×D
10 ~ 20	40
20.5~42	60

Spring collet standard set



CODE	Collet inner diameter	Q'ty	Holder type
C10-Aset	3, 4, 5, 6, 8, 10	6pcs. (1ea.)	CTA10
C20-Aset	6, 8, 10, 12, 16, 20		CTA20
C25-Aset	6, 8, 10, 12, 16, 20, 25	7pcs. (1ea.)	CTA25

- Std. Access.
 - Collet remover (C10-A set)

Collet remover

The collet can be attached/detached with ease.

CODE	Holder type
C10-RM	C10
C20-RM	C20
CE-CTS10	CTS10

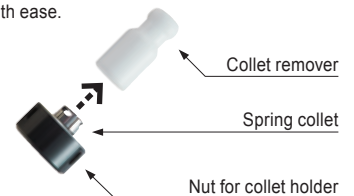

COOLANT-THROUGH SYSTEM

CODE	Retention knob with hole
BT30 -CTH10- 45	Model no. of retention knob depends on the machine model.
- 75	
-CTH20- 60	
- 90	
BT40 -CTH10- 60	
- 90	
-120	
-150	
-CTH20- 60	
- 90	
-120	
-150	
-CTH25- 75	
-105	
BT50 -CTH10-105	
-135	
-165	
-CTH20-105	
-135	
-165	
-CTH25- 75	
-105	
-CTH32- 90	
DN40AD-CTH20- 75	
-135	
-CTH25- 75	
DN50AD-CTH20-105	
-165	
-CTH25-105	

Coolant-through cutter SUKIMA through

Coolant screw	H	SUKIMA nut
CSA-M14	22~38	NUB-CTH10
-	22~68	-CTH20
※1	-	
CSA-M14	22~54	NUB-CTH10
-	22~67	-CTH20
-M24S	44~54	-CTH25
-M24L	36~46	-CTH32
-M24S	44~79	-CTH25
-M24L	36~71	-CTH32
-M24S	44~83	-CTH25
-M24L	36~75	-CTH32
-M24S	44~89	-CTH25
-M24L	36~81	-CTH32
-M24S	61~73	-CTH25
-M24L	53~65	-CTH32
-M28	61~80	-CTH25
CSA-M14	22~49	NUB-CTH10
-	22~67	-CTH20
-M24S	44~81	-CTH25
-M24L	36~73	-CTH32
-M24S	44~89	-CTH25
-M24L	36~81	-CTH32
-M24S	44~89	-CTH25
-M24L	36~81	-CTH32
-M24S	61~79	-CTH25
-M24L	61~89	-CTH32
※1	-	
CSA-M24S	44~ 69	NUB-CTH20
-M24L	36~ 61	-CTH25
-M24S	44~ 89	-CTH25
-M24L	36~ 81	-CTH25
-M24S	61~ 73	-CTH25
-M24L	53~ 65	-CTH25
CSA-M24S	44~ 89	NUB-CTH20
-M24L	36~ 81	-CTH20
-M24S	44~ 89	-CTH20
-M24L	36~ 81	-CTH20
-M28	61~ 90	-CTH25

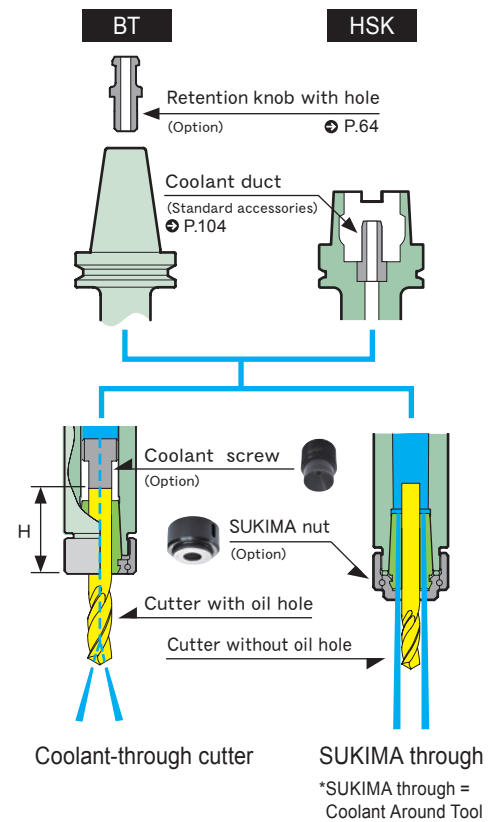

Coolant-through cutter SUKIMA through
*SUKIMA through = Coolant Around Tool

Coolant screw

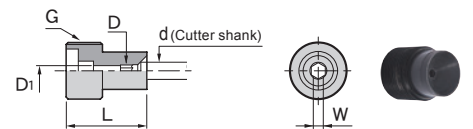

CODE	φD	φd	L	G	W
CSR-14	3	4~10	14	-	-
CP -14M		7~10	53	M14×1.5	3
CSA-M14	2.4	4~10	26		2
-M24S	7	10~20	30	M24×1.5	6
-M24L	3.4	6~12	38		3
-M28	6	10~25	40	M28×1.5	5

SUKIMA nut

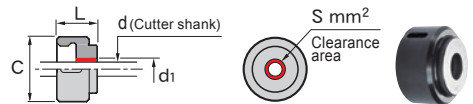

CODE	φC	L	φd	φd1	S
NUB-CTH10- 3.6	36	23	3	3.6	3.1
- 4.5			4	4.5	3.3
- 5.5			5	5.5	3.7
- 6.4			6	6.4	3.9
- 8.4			8	8.4	4.6
-10.3			10	10.3	4.8
-CTH20- 6.4	50	30	6	6.4	3.9
- 8.4			8	8.4	4.6
-10.3			10	10.3	4.8
-12.3			12	12.3	
-16.2			16	16.2	5.1
-20.2			20	20.2	5.7
-CTH25-20.2	62	34.5			
-25.2			25	25.2	5.9
-CTH32-25.2	74	38			
-32.1			32	32.1	6.0

Note

- For information on the asterisked (※1) coolant screw for the coolant-through cutter capability, please contact MST.
- A coolant duct is built into every tooling holder. However, the coolant ducts marked with ※2 are optional.
- Applicable for CTA type too. Please contact us for more information.

Caution

- Only the reference cutter size can be used.

Hi-ART MILLING CHUCK

Needle-roller type chuck

The Hi-ART milling chuck achieves the accuracy, rigidity and torque required of a milling chuck. Ideal for use as the end-milling base holder!!



Shrinker

Thanks to the shrinker, the cutter shank is chucked evenly from the bottom to the top of the gripping range, ensuring high rigidity and gripping force.

coolant-through



Nozzle-through



Coolant-Through Cutter

The shortest holder length is 85mm (BT40).

The shorter holder length means increased rigidity. The rigidity of the tool holder is inversely proportional to the cube of the length, meaning the deflection of this holder is about half that of a 105mm holder.

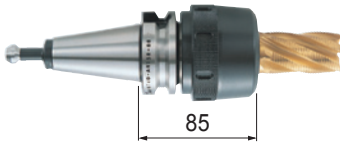

Memory line clearly confirms tightness of the nut.

You can check the recommended degree of tightening at a glance. Also, it only takes about one and half turns for tightening operation.



Keeps chips and coolant out completely

Dust-proof cover keeps chips and coolant out completely.

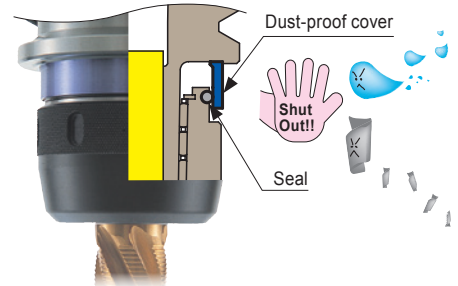

Applicable for coolant-through version

Nozzle-through

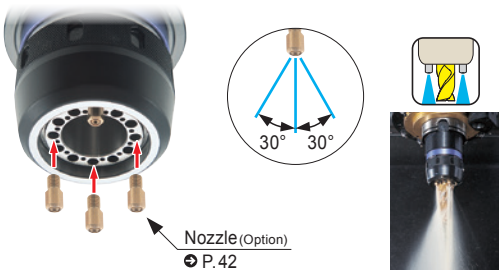

Coolant-Through Cutter

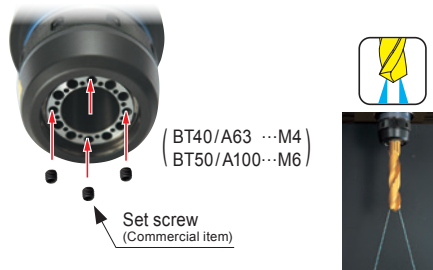

Longer cutter life using through-spindle capability → P.117

Applicable as a base holder for various applications

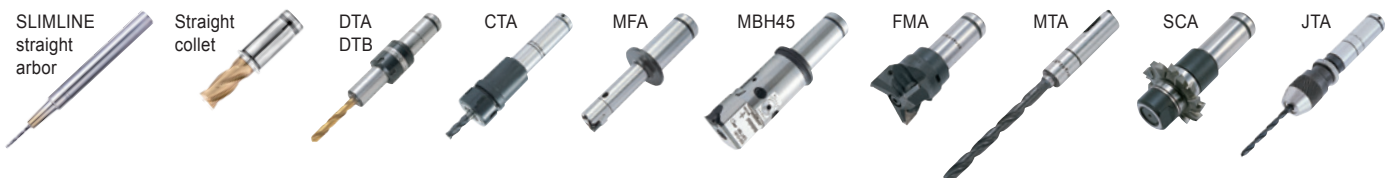

Hi-ART MILLING CHUCK (ART)

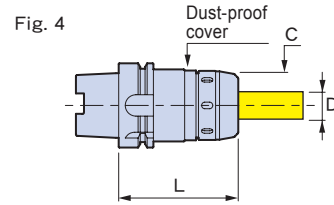
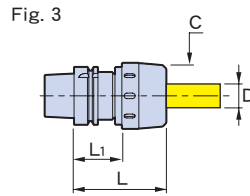
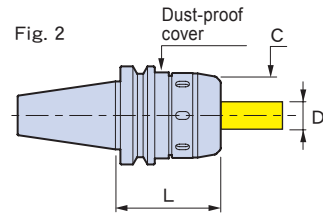
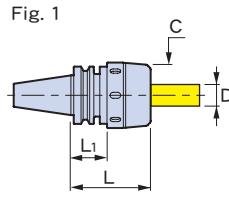

CODE	Fig.	φD	L	φC	L1	Cutter insertion length	Kg	MAX. min-1
BT40-ART32- 85	1	32	85	72	37	66~ 88	1.9	6,000
- 95			95		47		2.1	
-105			105		57		2.3	
-135			135		87		3.0	
BT50-ART32-105	2	32	105	82	—	66~ 98	5.1	5,000
-135			135				6.4	
-165			165				7.7	
-180			180				8.4	
-ART42-105			42				105	
-135		135		7.1				
A50M-ART32-100	3	32	100	72	44	66~ 71	1.7	6,000
A63 -ART32-100	3	32	100	72	44	66~ 71	2.0	6,000
A100-ART32-135	4	32	135	82	—	66~ 98	5.3	5,000
-ART42-135								

Option

- Straight collet→P.42 • Nozzle→P.42 • Spanner with ejection hook→P.42
- Adjust screw→P.42 • Retention knob(BT)→P.64

Std. Access.

- Coolant duct(Fixed)(HSK-A)→P.104

Note

- To utilize the coolant-through nozzle capability, the retention knob with hole and nozzle are required.
- Swing type coolant ducts are available upon request(HSK-A). For details, please contact us.

Caution

- For BT40 type, the outer diameter of the nut is larger than that of the V-flange. Therefore, pay close attention to possible interference with the ATC arm.
- When using the straight arbor in BT40, use the S type (ex.S32-CTA10).
- For A50M and A63, the coolant-through system is not available for straight collets.
- Cutter-through coolant is not available for straight collets.
- For precautions and maintenance, refer to page 116.

Increased rigidity with the Face Lock system

For face milling applications, combining a holder and a face mill arbor, with backup screw (ST32B, ST42B-FMA), will achieve strong gripping (Face Lock) and improve the rigidity during transverse feed milling.

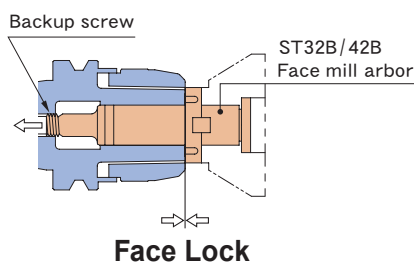

Straight collet

Standard type



F type

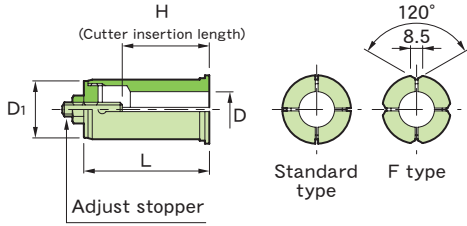

CODE		φD	L	φD1	H	Holder type
Standard type	F type					
S32- 6	S32- 6F	6	75	32	30~68	ART32
- 8	- 8F	8			40~68	
-10	-10F	10			50~68	
-12	-12F	12			55~68	
-16	-16F	16				
-20	-20F	20				
-25	-25F	25				
S42- 6	S42- 6F	6	80	42	30~73	ART42
- 8	- 8F	8			45~73	
-10	-10F	10			50~73	
-12	-12F	12				
-16	-16F	16				
-20	-20F	20				
-25	-25F	25				
-32	-32F	32				

- **Caution**
 - Remove the adjust stopper when using a straight collet with A50M/ A63.
 - When a straight collet with nozzles is used, use the F type.
- **Std. Access.**
 - Adjust stopper

Spanner with ejection hook

This spanner can be used to both tighten a nut and remove a straight collet.

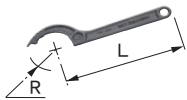

CODE	R	L	Holder type	Clamping torque(N·m)
FM-72	36	204	ART32 (BT40, A50M, A63)	60
-82	41	234	ART32 (BT50, A100)	70
-97	48.5	239	ART42 (BT50, A100)	

Nozzle

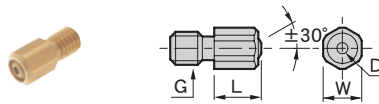

CODE	L	G	W	φD	Holder type	Q'ty
NOZ-M4-12	6.3	M4	4.5	1.2	BT40, A50M, A63	12pcs.
-60						60pcs.
-M6-12	8.5	M6	7	1.8	BT50, A100	12pcs.
-60						60pcs.

- **Std. Access.**
 - Wrench for attachment

Adjust screw

The overhang of the cutting tool can be adjusted.

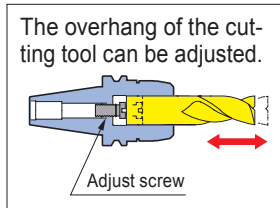
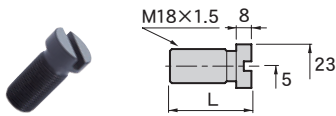

CODE	L	Shank type	Q'ty
AJN-M18L	38	BT40	5pcs.
-M18	63	BT50	

Cutting data

S55C
φ32 roughing end mill 4 flutes

n 350 min⁻¹
Vf 154 mm/min
Vc 35 m/min
fz 0.11 mm/t

BT40-ART32-85

S55C
φ32 roughing end mill 4 flutes

n 350 min⁻¹
Vf 181 mm/min
Vc 35 m/min
fz 0.13 mm/t

BT50-ART32-105

The ace for heavy-duty cutting!! The set screw holder that doesn't need a whistle notch.

- ▷ Accuracy → Less than $20\mu\text{m} / 100\text{L}$
- ▷ Gripping force → $4000\text{N} \cdot \text{m} (\phi 42)$



Adjustable projection of cutting tool

Our original tightening pad system allows a round shank, as well as a whistle notch shank end mill, to be used. The projection of the cutting tool, which is critical for heavy-duty cutting, can be made as short as possible.

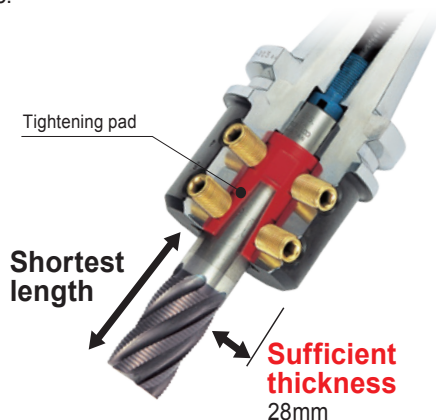

Applicable for coolant-through version (A100)

Nozzle-through

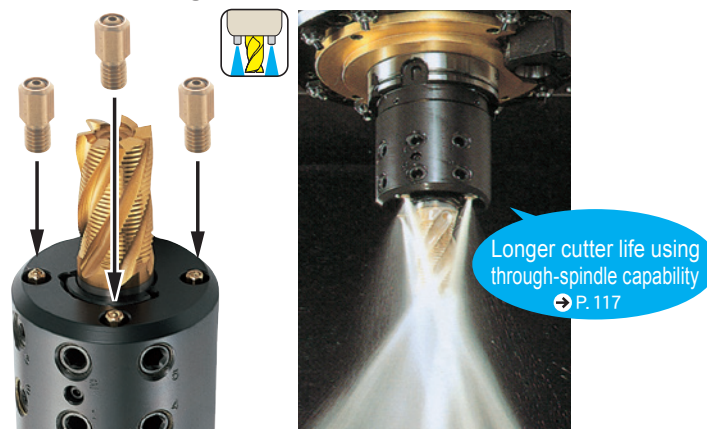

Applicable to high-speed cutting

Pre-balanced design

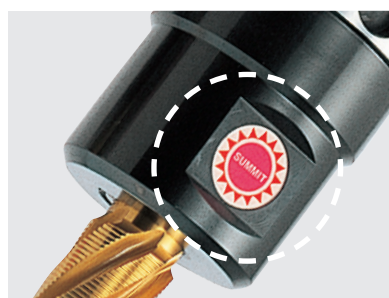

High accuracy thanks to its eccentric bore design

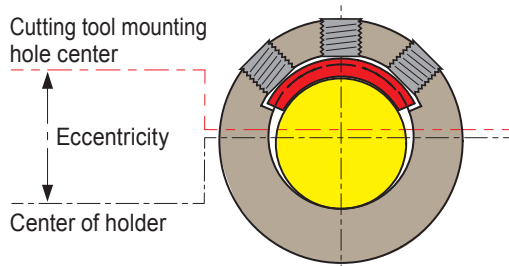

SUMMIT (SLZ)



BT50-SLZ32-105



A100-SLZ32-135

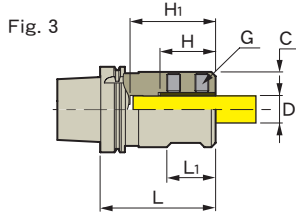
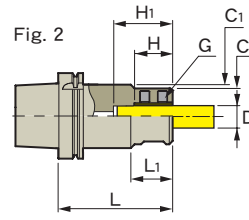
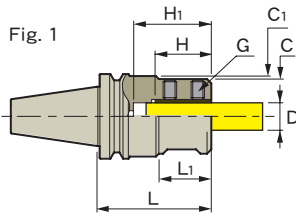

CODE	Fig.	φD	L	L ₁	φC	φC ₁	H	H ₁	G	Kg
BT50-SLZ25- 90	1	25	90	—	66	—	45	70	4-M12	4.6
-120			120	45		75				5.6
-150			150	—		—				6.5
-SLZ32-105	1	32	105	—	88	—	65	100	6-M16	5.9
-135			135	62		95				7.5
-165			165	—		—				9.1
-SLZ42-105	1	42	105	—	98	—	70	110	—	6.1
-135			135	—		—				7.8
-165			165	—		—				9.5
A 100-SLZ25-135	2	25	135	66	66	75	45	70	4-M12	4.9
-SLZ32-135	3	32		88	88	—	65	100	6-M16	6.1
-SLZ42-135	3	42		98	98	—	70	—	—	6.6

- Option**
 • Wrench • Adjust screw (BT50) • Nozzle (HSK-A100) • Retention knob(BT50)→P.64
- Std. Access.**
 • Coolant duct(Fixed) (HSK-A100)→P.104
- Note**
 • Swing type coolant ducts are available upon request(HSK-A). For details, please contact us.

- Caution**
 • If the dedicated wrench is not used, use a wrench with a minimum handle length of 30 cm for the M16 or 20 cm for the M12.
 • For precautions and maintenance, refer to page 117.

Wrench

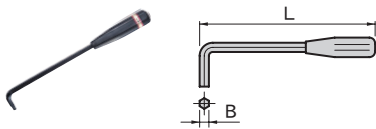

CODE	Holder type	B	L	Tightening torque(N·m)
W-206	SLZ25	6	200	40
-308	SLZ32 SLZ42	8	300	100

Nozzle

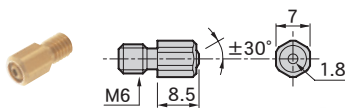

CODE	Q'ty
NOZ-M6-12	12pcs.
-60	60pcs.

- Std. Access.**
 • Wrench for attachment

Adjust screw

The overhang of the cutting tool can be adjusted.

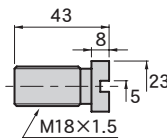

CODE	Shank type	Q'ty
AJC-M18L	BT50	5pcs.

The overhang of the cutting tool can be adjusted.

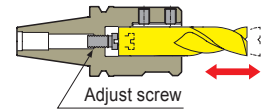

Cutting data

Tool	End Mill	Flutes	n	Vf	Vc	fz
A2017	φ38 end mill	4	5000 min ⁻¹	5000 mm/min	597 m/min	0.25 mm/t
S50C	φ40 roughing end mill	6	280 min ⁻¹	168 mm/min	35 m/min	0.1 mm/t
S50C	φ45 roughing end mill	6	190 min ⁻¹	114 mm/min	25 m/min	0.1 mm/t

The solution for high-efficient machining of deep cavity application.

1

Roughing

With a solid carbide core



FMH RIGID type Ⓢ P.46

Ideal for heavy duty roughing application at shallow and deep machining using a face milling arbor with a large size solid carbide core.

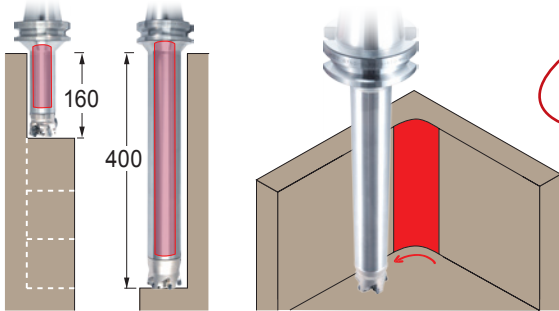

2

Semi-finishing

For screw-in end-mills



RED SCREW ARBOR Ⓢ P.48

Less vibration at a corner and pocket machining thanks to a solid design using a carbide shaft.

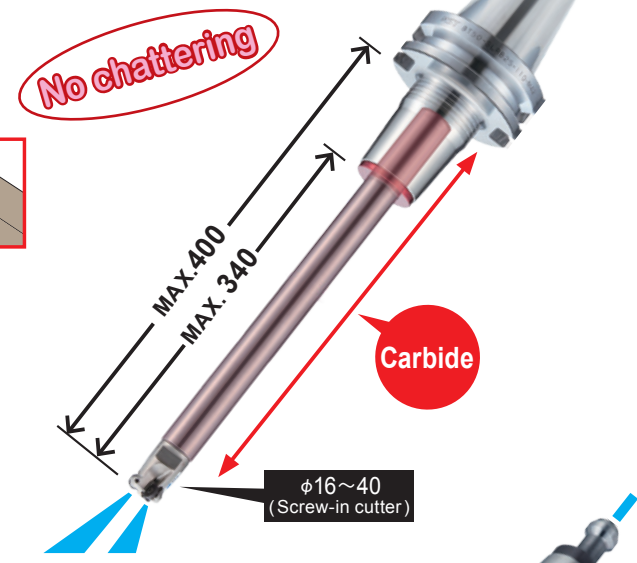
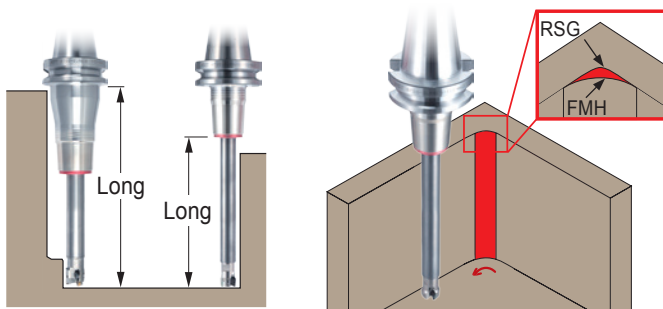

3

Finishing

SHRINK-FIT HOLDER



SLIMLINE MONO CURVE

Superior Accessibility.
Slim tip design of Curve minimizes cutter projection.

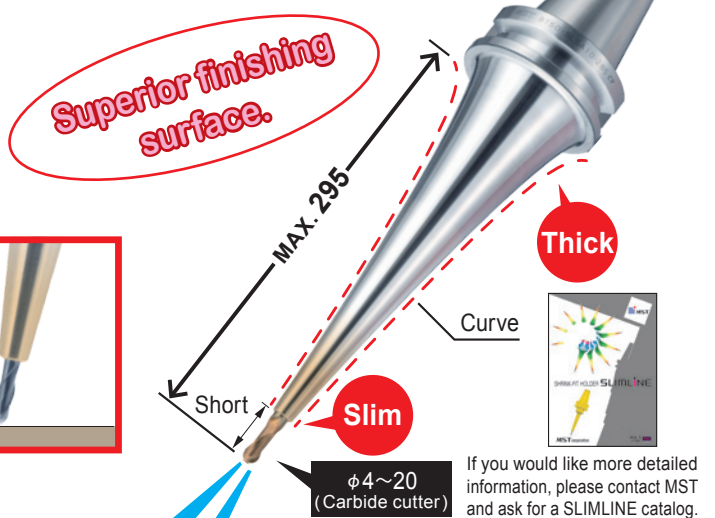
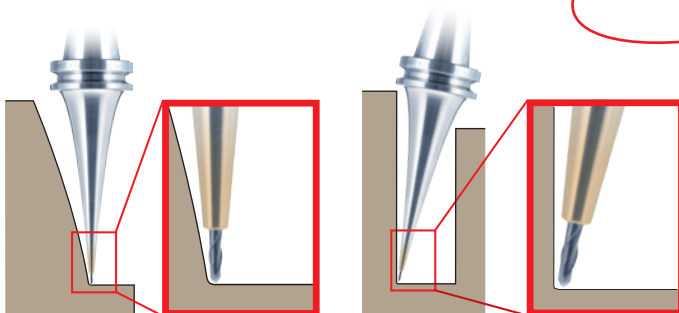

If you would like more detailed information, please contact MST and ask for a SLIMLINE catalog.

Achieves higher efficiency during long gauge length machining. Achieves stable machining during long, continuous operation.

FMH-H

▷ **Machining efficiency 2 times**
(Compared to conventional holders)

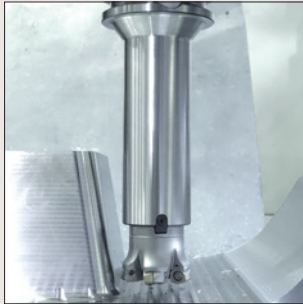

coolant-through



Large dia. Carbide core

The large-diameter carbide core is integrated into the thick body by shrink-fitting. Achieves less deflection and higher efficiency during long-gauge machining. Vibration-free machining leads to longer insert life and achieves stable machining during long and continuous operation.

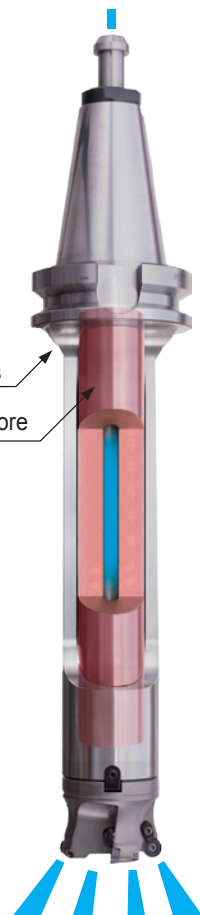

FMH standard

Available for FMH standard cutting tools that supplies coolant to the cutting edge properly.

Works with these manufacturers' cutting tools

OSG KYOCERA DIJET INDUSTRIAL Tungaloy
MITSUBISHI MATERIALS Mitsubishi Hitachi Tool Engineering

Even greater efficiency!

Effective length of our line up is from 110mm to 360mm and cutter dia of our line up is from φ40 to φ100. Shorter and longer gauge length models added to our current line up. Ideal for deep cavity mold applications. Makes more efficient roughing possible.

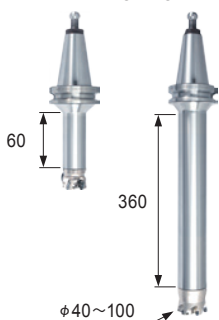

Comparison test

Cutting depth a_p (mm)	0.5	1.0	1.5	2.0
FMH RIGID type BT50-FMH22-60-315H	○	○	○	○
Conventional BT50-FMH22-60-300	○	✗ Chattering		

Double the Machining efficiency

- Application: Shouldering
- Material: S50C (Mild steel)
- Cutting speed: 220 m/min (S1,112 min⁻¹)
- Feed rate: 1,112 mm/min

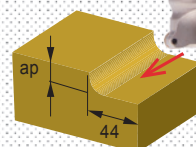

Cutter dia. φ63
4-flutes
Round insert

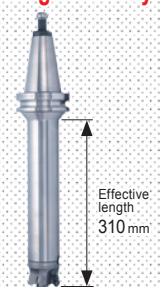

FMH RIGID type with a solid carbide core (FMH-H)

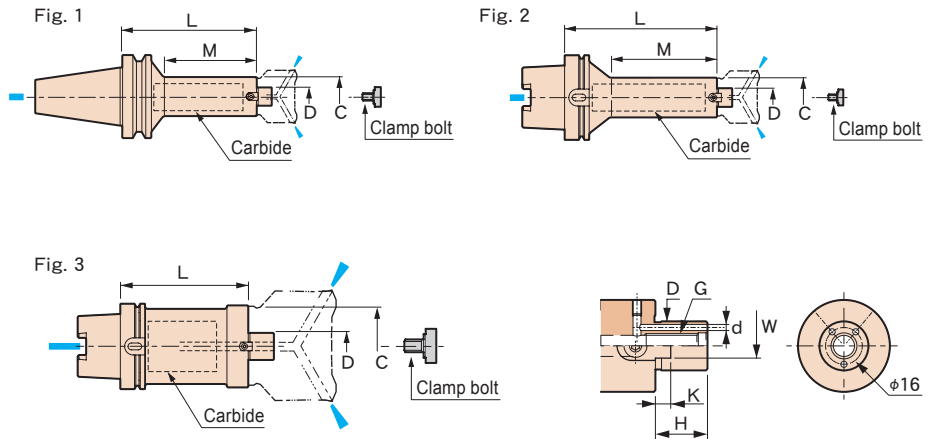

CODE	Fig.	L	M	Kg	Moment kgf·m
BT50-FMH16 -37-125H	1	125	60	5.2	—
NEW -175H		175	110	5.8	
-225H		225	160	6.5	
-275H		275	210	7.1	
-325H		325	260	7.8	
BT50-FMH22 -47-165H	1	165	110	5.7	0.1
-215H		215	160	6.5	0.2
-265H		265	210	7.3	0.3
-315H		315	260	8.2	0.6
-365H		365	310	9.0	0.8
BT50-FMH22 -60-165H	1	165	110	6.9	0.2
-215H		215	160	8.1	0.3
-265H		265	210	9.3	0.6
-315H		315	260	10.7	1.0
-365H		365	310	11.9	1.3
-415H		415	360	13.1	1.7
BT50-FMH31.75-76-215H	1	215	160	10.6	0.6
-265H		265	210	12.7	1.0
-315H		315	260	15.3	1.5
-365H		365	310	17.6	2.3
A100-FMH16 -37-125H	1	125	60	3.9	—
NEW -175H		175	110	4.5	
-225H		225	160	5.2	
-275H		275	210	5.8	
-325H		325	260	6.4	
A100-FMH22 -47-165H	2	165	110	4.2	0.1
-215H		215	160	5.1	0.3
-265H		265	210	5.9	
-315H		315	260	6.8	0.6
-365H		365	310	7.6	0.8
A100-FMH22 -60-165H	2	165	110	5.9	0.2
-215H		215	160	7.2	0.5
-265H		265	210	8.4	0.7
-315H		315	260	9.8	1.1
-365H		365	310	11.1	1.4
-415H		415	360	12.4	1.8
A100-FMH31.75-76-215H	2	215	160	9.7	0.7
-265H		265	210	11.8	1.2
-315H		315	260	14.0	1.7
-365H		365	310	16.3	2.4
A100-FMH31.75-96-250H	3	250	—	13.6	1.3
-300H		300		16.3	2.0
-350H		350		17.4	2.6

Common dimensions

CODE	Cutter dia.	φD	H	φC	W	K	φd	G	Clamp bolt
FMH16 -37	40	16	17	37	8	5	2	M 8	M 8※
FMH22 -47	50/52	22	18	47	10	5	3	M10	M10※
FMH22 -60	63/66	22	18	60	10	5	3	M10	M10※
FMH31.75-76	80	31.75	30	76	12.7	7	4	M16	MBF-M16
-96	100	31.75	30	96	12.7	7	4	M16	MBF-M16

Option

- Retention knob (BT50) → P.64

Std. Access.

- Coolant duct (Fixed) (HSK-A100) → P.104
- Clamp bolt (unless marked with in the list) • Stopper key

Note

- Swing type coolant ducts are available upon request (HSK-A). For details, please contact us.
- The clamp bolt marked with ※ in the list is a hexagonal socket bolt. Use a market standard bolt.
- Contact us to find out what manufacturers' cutters can be used with this product.

Caution

- The required clamp bolt design depends on the cutter manufacturer and the type of cutter.

Available for
DIN/ CAT.

RED SCREW arbor

PAT.

The arbor for screw-in End Mill

Displaying the highest cutting performance of any screw-in end mill!!

- ▷ Highly rigid design makes the best use of carbide properties (high Young's modulus).
- ▷ Ideal for deep standing-wall machining.

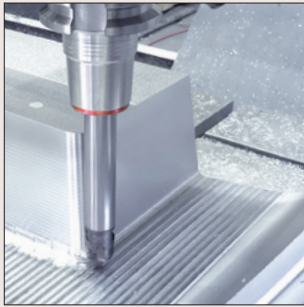

coolant-through



RSG

Carbide integral type

Carbide

NEW

φ16~40
Screw-in tool

Under-cut design

Works with these manufacturers' tools

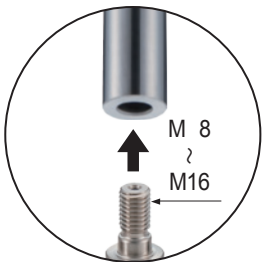

Many effective lengths for machining

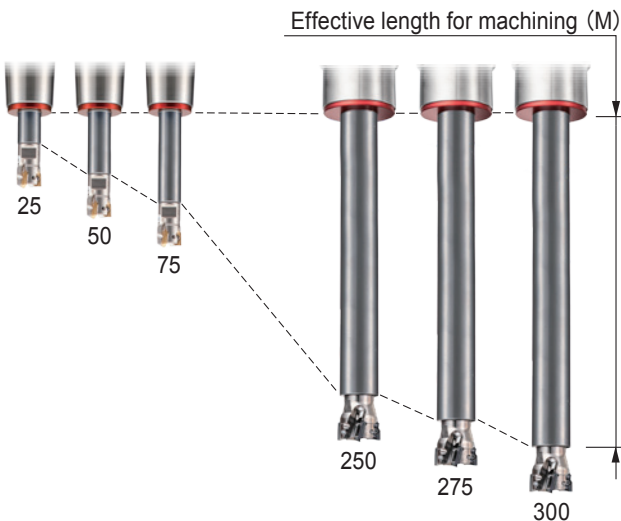

Heavy cutting ↔ Deep standing-wall machining

Machining example

RED screw arbor
BT50-RSG12-215-M100

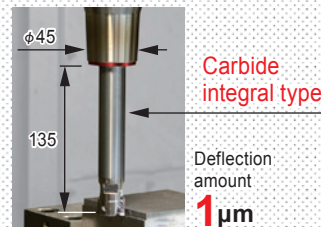

A general holder +
A steel shank

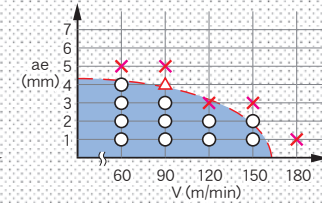
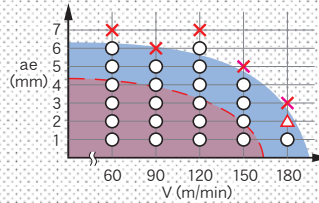
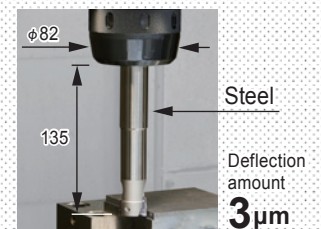

○ Excellent
✗ Chattering

Cutting condition

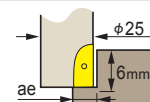

2-flutes end-mill
Climb milling
Feed : 0.1mm/tooth
Material : S50C

RED SCREW arbor (RSG)

BT



Rigidity value ($\mu\text{m} / \text{kgf}$)

S

BT50-RSG16-400-M225

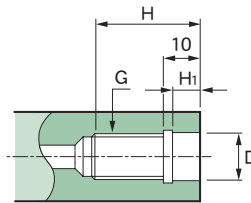
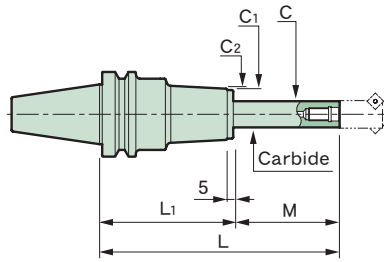

Dimensions for the screw-in end mill mounting.

Available for
DIN/ CAT.

■ Option

- Retention knob → P.64

■ Caution

- Some of the screw-in end mills cannot be attached to the RED screw arbor. Please check your screw-in end mills for conformance to the dimensions, or please contact MST.
- Because cutting resistance is greater than the tool holder connection force associated with the machine spindle, please reduce the recommended cutting conditions by 50% for the RED screw arbors marked with ※. Otherwise, the tool holder shank may experience fretting corrosion or fall out of the machine spindle.

S The rigidity value

A rigidity value represents the amount of deflection for the entire holder and tool when a bending load of 1 kgf (9.8 N) is applied to the tip of the tool. The smaller the numerical value is, the higher the rigidity and the more accurate the machining.

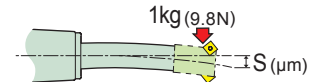

CODE	L	M	L1	Kg	S
BT40-RSG 8-105-M 25	105	25	80	1.4	0.6
-135-M 25	135		110	1.8	0.7
-165-M 25	165		140	2.1	0.8
-130-M 50	130	50	80	1.4	1.5
-160-M 50	160		110	1.8	1.7
-190-M 50	190		140	2.1	1.8
-155-M 75	155	75	80	1.5	3.1
-185-M 75	185		110	1.9	3.4
-215-M 75	215		140	2.2	3.5
-170-M 90	170	90	80	1.5	4.5
-200-M 90	200		110	1.9	4.8
-230-M 90	230		140	2.2	4.9
-185-M105	185	105	80	1.6	6.2
-215-M105	215		110	2.0	6.7
-245-M105	245		140	2.3	6.8
BT40-RSG10-125-M 25	125	25	100	1.8	0.4
-155-M 25	155		130	2.2	0.5
-185-M 25	185		160	2.4	0.7
-150-M 50	150	50	100	1.9	0.8
-180-M 50	180		130	2.3	1.0
-210-M 50	210		160	2.5	1.2
-175-M 75	175	75	100	2.0	1.6
-205-M 75	205		130	2.4	1.8
-235-M 75	235		160	2.6	2.0
-200-M100	200	100	100	2.0	2.7
-230-M100	230		130	2.4	3.0
-260-M100	260		160	2.6	3.3
-220-M120	220	120	100	2.1	4.0
-250-M120	250		130	2.5	4.3
-280-M120	280		160	2.7	4.6
BT40-RSG12-125-M 25	125	25	100	2.0	0.3
-155-M 25	155		130	2.4	0.4
-185-M 25	185		160	2.7	0.5
-150-M 50	150	50	100	2.1	
-180-M 50	180		130	2.5	0.7
-210-M 50	210		160	2.8	0.9
-175-M 75	175	75	100	2.3	
-205-M 75	205		130	2.7	1.1
-235-M 75	235		160	3.0	1.3

CODE	L	M	L1	Kg	S
BT40-RSG12-200-M100	200	100	100	2.4	1.4
-230-M100	230		130	2.8	1.6
-260-M100	260		160	3.1	1.9
-225-M125	225	125	100	2.6	2.1
-255-M125	255		130	3.0	2.4
-285-M125	285		160	3.3	2.8
BT40-RSG16-125-M 25	125	25	100	2.6	0.2
-150-M 50	150	50		2.8	0.3
-175-M 75	175	75		3.0	0.5
-200-M100	200	100		3.2	0.8
-225-M125※	225	125		3.4	1.2
BT50-RSG 8-120-M 25	120	25	95	4.0	0.6
-150-M 25	150		125	4.3	0.7
-180-M 25	180		155	4.8	
-145-M 50	145	50	95	4.0	1.5
-175-M 50	175		125	4.3	1.7
-205-M 50	205		155	4.8	
-170-M 75	170	75	95	4.1	3.1
-200-M 75	200		125	4.4	3.4
-230-M 75	230		155	4.9	
-185-M 90	185	90	95	4.1	4.4
-215-M 90	215		125	4.4	4.8
-245-M 90	245		155	4.9	
-200-M105	200	105	95	4.2	6.2
-230-M105	230		125	4.5	6.6
-260-M105	260		155	5.0	
BT50-RSG10-140-M 25	140	25	115	4.3	0.4
-170-M 25	170		145	4.6	0.5
-200-M 25	200		175	5.6	
-165-M 50	165	50	115	4.4	0.8
-195-M 50	195		145	4.7	0.9
-225-M 50	225		175	5.7	1.0
-190-M 75	190	75	115	4.5	1.6
-220-M 75	220		145	4.8	1.7
-250-M 75	250		175	5.8	1.8
-215-M100	215	100	115	4.5	2.7
-245-M100	245		145	4.8	2.9
-275-M100	275		175	5.8	

Common dimensions

CODE	Cutter dia.	G	φD	H	H ₁	φC	φC ₁	φC ₂
RSG 8	16	M 8	8.5	18	6.5	15	30	32
RSG10	20	M10	10.5	22	6.5	19	36	38
RSG12	25	M12	12.5	22	6	24	43	45
RSG16	32/40	M16	17	25	6	29	52	54
RSG16-37	40	M16	17	25	6	37	71	73



BT50-RSG16-37-265-M150

CODE	L	M	L ₁	Kg	S
BT50-RSG10-235-M120	235	120	115	4.6	3.9
-265-M120	265		145	4.9	4.2
-295-M120	295		175	5.9	
-255-M140	255	140	115	4.7	5.5
-285-M140	285		145	5.0	5.8
-315-M140	315		175	6.0	
BT50-RSG12-140-M 25	140	25	115	4.6	0.2
-170-M 25	170		145	5.0	0.3
-200-M 25	200		175	5.8	0.4
-165-M 50	165	50	115	4.7	0.5
-195-M 50	195		145	5.1	0.6
-225-M 50	225		175	5.9	
-190-M 75	190	75	115	4.9	0.8
-220-M 75	220		145	5.3	1.0
-250-M 75	250		175	6.1	
-215-M100	215	100	115	5.0	1.3
-245-M100	245		145	5.4	1.5
-275-M100	275		175	6.2	1.6
-240-M125	240	125	115	5.2	2.1
-270-M125	270		145	5.6	2.3
-300-M125	300		175	6.4	2.4
-265-M150	265	150	115	5.3	3.0
-295-M150	295		145	5.7	3.3
-325-M150	325		175	6.5	3.4
-290-M175	290	175	115	5.5	4.2
-320-M175	320		145	5.9	4.6
-350-M175	350		175	6.7	
BT50-RSG16-140-M 25	140	25	115	4.8	0.2
-170-M 25	170		145	5.4	
-200-M 25	200		175	6.6	
-165-M 50	165	50	115	5.0	0.3
-195-M 50	195		145	5.6	0.4
-225-M 50	225		175	6.8	
-190-M 75	190	75	115	5.3	0.5
-220-M 75	220		145	5.9	0.6
-250-M 75	250		175	7.0	
-215-M100	215	100	115	5.5	0.7
-245-M100	245		145	6.1	0.9
-275-M100	275		175	7.2	
-240-M125	240	125	115	5.7	1.1
-270-M125	270		145	6.3	1.3

CODE	L	M	L ₁	Kg	S
BT50-RSG16-300-M125	300	125	175	7.4	1.3
-265-M150	265	150	115	5.9	1.6
-295-M150	295		145	6.5	1.8
-325-M150	325		175	7.7	
-290-M175	290	175	115	6.1	2.2
-320-M175	320		145	6.7	2.4
-350-M175	350		175	7.9	2.5
-315-M200	315	200	115	6.3	3.0
-345-M200	345		145	6.9	3.2
-375-M200	375		175	8.1	3.3
-340-M225	340	225	115	6.5	3.9
-370-M225	370		145	7.1	4.1
-400-M225	400		175	8.3	4.2
BT50-RSG16- 37-190-M 75	190	75	115	6.8	0.2
-215-M100	215	100			0.3
NEW -240-M125	240	125		7.6	0.4
-265-M150	265	175			0.6
-290-M175	290	200		8.3	0.9
-315-M200	315	225			1.1
-340-M225	340	250		9.0	1.5
-365-M250	365	250			1.9
-390-M275	390	275		9.7	2.4
-415-M300	415	300			2.9

RED SCREW arbor (RSG)

HSK-A

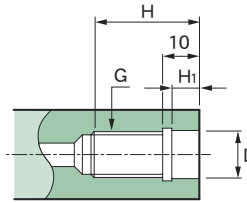
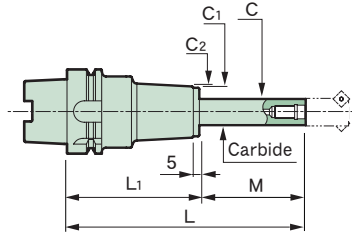

Dimensions for the screw-in end mill mounting.

Std. Access.

- Coolant duct (Fixed type) → P.64

Note

- Swing type coolant ducts are available upon request. For details, please contact us.

Caution

- Some of the screw-in end mills cannot be attached to the RED screw arbor. Please check your screw-in end mills for conformance to the dimensions, or please contact MST.
- Because cutting resistance is greater than the tool holder connection force associated with the machine spindle, please reduce the recommended cutting conditions by 50% for the RED screw arbors marked with ※. Otherwise, the tool holder shank may experience fretting corrosion or fall out of the machine spindle.

S The rigidity value

A rigidity value represents the amount of deflection of the entire holder and tool when a bending load of 1 kgf (9.8 N) is applied to the tip of the tool. The smaller the numerical value is, the higher the rigidity and the more accurate the machining.

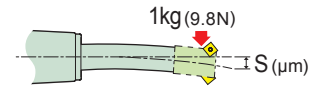





CODE	L	M	L ₁	Kg	S
A63-RSG 8-105-M 25	105	25	80	1.3	0.6
-135-M 25	135		110	1.4	0.7
-165-M 25	165		140	1.9	0.8
-130-M 50	130	50	80	1.3	1.5
-160-M 50	160		110	1.4	1.7
-190-M 50	190		140	1.9	
-155-M 75	155	75	80	1.4	3.1
-185-M 75	185		110	1.5	3.4
-215-M 75	215		140	2.0	
-170-M 90	170	90	80	1.4	4.4
-200-M 90	200		110	1.5	4.8
-230-M 90	230		140	2.0	4.9
-185-M105	185	105	80	1.5	6.2
-215-M105	215		110	1.6	6.6
-245-M105	245		140	2.1	6.7
A63-RSG10-125-M 25	125	25	100	1.6	0.4
-155-M 25	155		130	1.9	0.5
-185-M 25	185		160	2.3	0.6
-150-M 50	150	50	100	1.7	0.8
-180-M 50	180		130	2.0	1.0
-210-M 50	210		160	2.4	1.2
-175-M 75	175	75	100	1.8	1.6
-205-M 75	205		130	2.1	1.8
-235-M 75	235		160	2.5	2.0
-200-M100	200	100	100	1.8	2.7
-230-M100	230		130	2.1	2.9
-260-M100	260		160	2.5	3.2
-220-M120	220	120	100	1.9	4.0
-250-M120	250		130	2.2	4.2
-280-M120	280		160	2.6	4.5
-240-M140	240	140	100	2.0	5.6
-270-M140	270		130	2.3	5.9
-300-M140	300		160	2.7	6.2

CODE	L	M	L ₁	Kg	S
A63 -RSG12-125-M 25	125	25	100	1.9	0.3
-155-M 25	155		130	2.3	0.4
-185-M 25	185		160	2.7	0.5
-150-M 50	150	50	100	2.0	
-180-M 50	180		130	2.4	0.6
-210-M 50	210		160	2.8	0.8
-175-M 75	175	75	100	2.2	0.9
-205-M 75	205		130	2.6	1.0
-235-M 75	235		160	3.0	1.3
-200-M100	200	100	100	2.3	1.4
-230-M100	230		130	2.7	1.6
-260-M100	260		160	3.1	1.9
-225-M125	225	125	100	2.5	2.1
-255-M125	255		130	2.9	2.4
-285-M125	285		160	3.3	2.7
-250-M150	250	150	100	2.6	3.1
-280-M150	280		130	3.0	3.4
-310-M150	310		160	3.4	3.8
A63 -RSG16-140-M 25	140	25	115	2.6	0.2
-165-M 50	165	50		2.8	0.4
-190-M 75	190	75		3.0	0.6
-215-M100	215	100		3.2	0.9
-240-M125※	240	125		3.4	1.3
-265-M150※	265	150		3.7	1.9
-290-M175※	290	175		3.9	2.5
A100-RSG 8-120-M 25	120	25	95	2.6	0.6
-150-M 25	150		125	2.9	0.8
-180-M 25	180		155	3.4	
-145-M 50	145	50	95	2.6	1.5
-175-M 50	175		125	2.9	1.7
-205-M 50	205		155	3.4	
-170-M 75	170	75	95	2.7	3.1
-200-M 75	200		125	3.0	3.4

Common dimensions

CODE	Cutter dia.	G	φD	H	H ₁	φC	φC ₁	φC ₂
RSG 8	16	M 8	8.5	18	6.5	15	30	32
RSG10	20	M10	10.5	22	6.5	19	36	38
RSG12	25	M12	12.5	22	6	24	43	45
RSG16	32/40	M16	17	25	6	29	52	54
RSG16-37	40	M16	17	25	6	37	71	73

CODE	L	M	L ₁	 Kg	 S	CODE	L	M	L ₁	 Kg	 S
A100-RSG 8-230-M 75	230	75	155	3.5	3.4	A100-RSG16-140-M 25	140	25	115	4.0	0.2
-185-M 90	185	90	95	2.7	4.5	-170-M 25	170		145	4.5	
-215-M 90	215		125	3.0	4.9	-200-M 25	200		175	5.7	
-245-M 90	245		155	3.5	4.8	-165-M 50	165	50	115	4.2	0.3
-200-M105	200	105	95	2.8	6.3	-195-M 50	195		145	4.7	0.4
-230-M105	230		125	3.1	6.7	-225-M 50	225		175	5.9	
-260-M105	260		155	3.6	6.6	-190-M 75	190	75	115	4.5	0.5
A100-RSG10-140-M 25	140	25	115	3.1	0.4	-220-M 75	220		145	5.0	0.6
-170-M 25	170		145	3.5	0.5	-250-M 75	250		175	6.1	
-200-M 25	200		175	4.4		-215-M100	215	100	115	4.7	0.8
-165-M 50	165	50	115	3.2	0.8	-245-M100	245		145	5.2	0.9
-195-M 50	195		145	3.6	1.0	-275-M100	275		175	6.3	
-225-M 50	225		175	4.5		-240-M125	240	125	115	4.9	1.1
-190-M 75	190	75	115	3.3	1.6	-270-M125	270		145	5.4	1.3
-220-M 75	220		145	3.7	1.8	-300-M125	300		175	6.5	
-250-M 75	250		175	4.6		-265-M150	265	150	115	5.1	1.6
-215-M100	215	100	115	3.3	2.7	-295-M150	295		145	5.6	1.8
-245-M100	245		145	3.7	2.9	-325-M150	325		175	6.7	
-275-M100	275		175	4.6		-290-M175	290	175	115	5.3	2.2
-235-M120	235	120	115	3.4	4.0	-320-M175	320		145	5.8	2.4
-265-M120	265		145	3.8	4.2	-350-M175	350		175	7.0	2.5
-295-M120	295		175	4.7		-315-M200	315	200	115	5.5	3.0
-255-M140	255	140	115	3.5	5.6	-345-M200	345		145	6.0	3.2
-285-M140	285		145	3.9	5.8	-375-M200	375		175	7.2	3.3
-315-M140	315		175	4.8		-340-M225	340	225	115	5.7	3.9
A100-RSG12-140-M 25	140	25	115	3.4	0.3	-370-M225	370		145	6.3	4.2
-170-M 25	170		145	3.7	0.4	-400-M225	400		175	7.4	
-200-M 25	200		175	4.7		A100-RSG16- 37-190-M 75	190	75	115	6.3	0.2
-165-M 50	165	50	115	3.5	0.5	NEW -215-M100	215	100			0.3
-195-M 50	195		145	3.8	0.6	-240-M125	240	125		7.1	0.4
-225-M 50	225		175	4.8		-265-M150	265	150			0.6
-190-M 75	190	75	115	3.7	0.8	-290-M175	290	175		7.8	0.9
-220-M 75	220		145	4.0	1.0	-315-M200	315	200			1.1
-250-M 75	250		175	5.0		-340-M225	340	225		8.5	1.5
-215-M100	215	100	115	3.8	1.4	-365-M250	365	250			1.9
-245-M100	245		145	4.1	1.6	-390-M275	390	275		9.2	2.4
-275-M100	275		175	5.1		-415-M300	415	300			2.9
-240-M125	240	125	115	4.0	2.1						
-270-M125	270		145	4.3	2.4						
-300-M125	300		175	5.3							
-265-M150	265	150	115	4.1	3.0						
-295-M150	295		145	4.4	3.4						
-325-M150	325		175	5.4							
-290-M175	290	175	115	4.3	4.3						
-320-M175	320		145	4.6	4.6						
-350-M175	350		175	5.6							

Cutter arbor with spindle-through coolant (FMH)

- ▷ Standard design has through-coolant holes that allow superior chip evacuation, cutting edge cooling and lubrication.
- ▷ Achieves amazing high-feed machining
- ▷ We also have a variety of ultra-long type arbors.

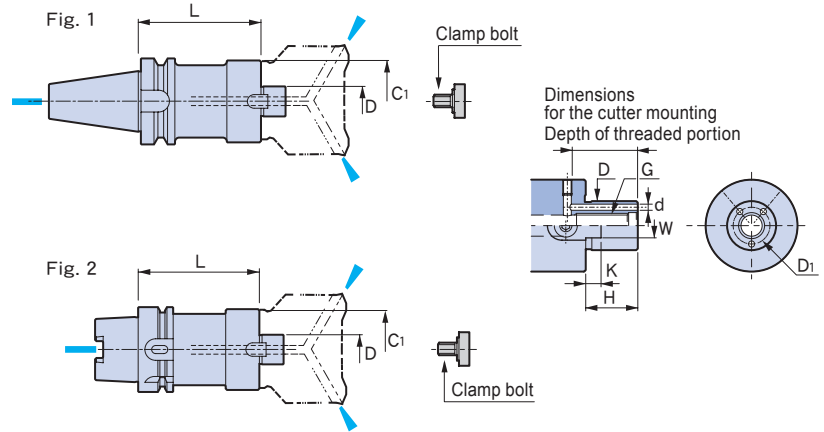

CODE	Fig.	Cutter dia.	L	φC1	kg	
BT40-FMH16 -29- 45	1	32	45	29	1.1	
- 90			90		1.4	
-120			120		1.5	
-37- 45		40	45	37	1.2	
- 90			90		1.6	
-120			120		1.9	
BT40-FMH22 -47- 45	1	50/52	45	47	1.3	
- 90			90		1.9	
-150			150		2.7	
-200			200		3.3	
-60- 45			63/66	45	60	1.4
- 90		90			2.2	
-150		150			3.2	
-200		200			4.1	
BT40-FMH22.225-47- 45		1		50/52	45	47
- 90			90			1.9
-150	150				2.7	
-200	200				3.3	
-60- 45	63/66		45		60	1.4
- 90			90		2.2	
-150			150		3.2	
-200			200		4.1	
BT40-FMH25.4 -70- 60			1	80	60	70
- 90	90					2.4
-150	150				3.4	
BT40-FMH31.75 -76- 60	1	80			60	76
- 90			90		2.6	
-150			150		3.6	
-200			200		4.4	
-96- 60			100	60	96	2.4
- 90		90			3.1	
-150		150			4.1	
-200		200			4.9	
BT50-FMH16 -29- 90		1		32	90	29
-150			150			4.3
-37- 90	40		90	37	4.1	
-150			150		4.7	
-200			200		5.3	

CODE	Fig.	Cutter dia.	L	φC1	kg
BT50-FMH22 -47- 90	1	50/52	90	47	4.4
-150			150		5.4
-200			200		6.2
-250			250		7.2
-300			300		8.3
-60- 90	1	63/66	90	60	4.8
-150			150		6.4
-200			200		7.8
-250			250		9.2
-300			300		10.8
BT50-FMH22.225-47- 90	1	50/52	90	47	4.4
-150			150		5.4
-200			200		6.2
-250			250		7.2
-300			300		8.3
-60- 90		63/66	90	60	4.8
-150			150		6.4
-200			200		7.7
-250			250		9.2
-300			300		10.8
BT50-FMH25.4 -70- 60	1	80	60	70	4.4
- 90			90		5.3
-150			150		7.0
BT50-FMH31.75 -76- 60	1	80	60	76	4.5
- 90			90		5.6
-150			150		7.6
-200			200		9.3
-250			250		11.0
-300		300		12.8	
-96- 60		100	60	96	5.0
- 90			90		6.4
-150			150		9.2
-200			200		11.5
-250	250			13.8	
-300	300		16.2		
BT50-FMH38.1-100- 60	1	125	60	100	5.2
- 90			90		6.6
-150			150		9.4
-200			200		11.7
-250			250		13.9
BT50-FMH50.8-100- 60	1	160	60	100	5.4
- 90			90		6.9
-150			150		9.6
-200			200		11.8
-250			250		14.1

Common dimensions

CODE	φD	H	W	K	G	Clamp bolt
FMH16	16	17	8	5	M 8	M 8 ※
FMH22	22	18	10	5	M10	M10 ※
FMH22.225	22.225	17	8	3.5	M10	M10 ※
FMH25.4	25.4	22	9.5	5	M12	MBF-M12
FMH31.75	31.75	30	12.7	7	M16	MBF-M16
FMH38.1	38.1	34	15.9	9	M20	MBF-M20
FMH50.8	50.8	36	19.05	10	M24	MBF-M24

CODE	Fig.	Cutter dia.	L	φC1	kg			
A63 -FMH16 -29- 45	2	32	45	29	0.8			
			90		1.1			
			120		1.3			
			40	45	37	0.9		
			90		1.3			
			120		1.6			
A63 -FMH22 -47- 45	2	50/52	45	47	1.0			
			90		1.6			
			150		2.6			
			200		3.5			
			63/66	60	60	1.4		
			90		1.9			
			150		2.9			
			200		3.8			
			A63 -FMH22.225-47- 45	2	50/52	45	47	1.0
						90		1.6
150		2.6						
200		3.4						
63/66	60	60				1.4		
90		1.9						
150		2.9						
200		3.8						
A63 -FMH25.4 -70- 60	2	80				60	70	1.6
						90		2.1
			150		3.1			
			A63 -FMH31.75 -76- 60	2	80	60	76	1.7
90		2.3						
150		3.3						
200		4.1						
100	60	96				2.1		
90		2.9						
A100-FMH16 -29- 90	2	32	90	29	2.4			
			150		2.8			
			40	90	37	2.6		
			150		3.3			
			200		3.9			
			A100-FMH22 -47- 90	2	50/52	90	47	2.9
150		3.9						
200		4.8						
250		5.8						
300		6.9						

Clamp bolt

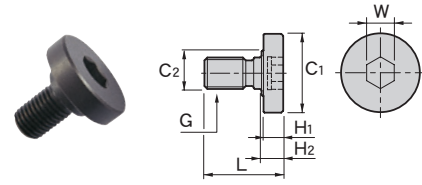

CODE	L	φC1	φC2	H1	H2	W	G	FMH model
MBF-M12	30	33	23	10	11	10	M12	FMH25.4
-M16	40	40				14	M16	FMH31.75
-M20	50	50	27	14	16	17	M20	FMH38.1
-M24	59	65	37			19	M24	FMH50.8

CODE	Fig.	Cutter dia.	L	φC1	kg	
A100-FMH22 - 60- 90	2	63/66	90	60	3.5	
			150		5.1	
			200		6.4	
			250		7.9	
			300		9.5	
			A100-FMH22.225- 47- 90	2	50/52	90
150		3.9				
200		4.8				
250		5.8				
300		6.9				
63/66	90	60			3.4	
	150				5.0	
	200				6.4	
	250				7.9	
	300				9.5	
A100-FMH25.4 - 70- 60	2	80	60	70	3.1	
			90		4.0	
			150		5.7	
A100-FMH31.75 - 76- 60	2	80	60	76	3.3	
			90		4.3	
			150		6.4	
			200		8.1	
			250		9.8	
			300		11.5	
			100	90	96	5.3
				150		8.1
				200		10.4
				250		12.7
A100-FMH38.1 -100- 90	2	125	90	100	5.5	
			150		8.2	
			200		10.5	
			250		12.8	
A100-FMH50.8 -100- 90	2	160	90	100	5.7	
			150		8.4	
			200		10.7	
			250		12.9	

- Option
 - Retention knob → P.64
- Std. Access.
 - Coolant duct(Fixed) (HSK-A) → P.104
 - Clamp bolt (unless marked with ※ in the list) • Stopper key
- Note
 - The clamp bolt marked with ※ in the list is a hexagonal socket bolt. Use a market standard bolt.
 - Swing type coolant ducts are available upon request. For details, please contact us.
- Caution
 - The required clamp bolt design depends on the cutter manufacturer and the type of cutter.

Applicable for all applications, from finishing to roughing.

MFA



Super precision finishing boring holder

MBH



Finishing and heavy duty boring holder

MBJ

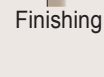

Wide range and multi-purpose boring holder

Super precision finishing boring holder

MFA P.57

Rigid design thanks to the square sliding head

The square slide system can achieve greater rigidity against cutting force compared to a round slide system since it has 2-face contact.

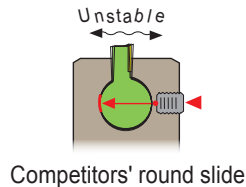
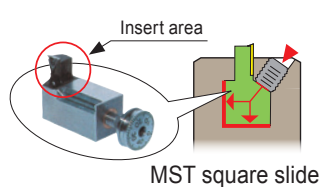

Guaranteed fine adjustment

It allows 0.01mm dia. fine adjustment easily and precisely. The setting diameter doesn't change when you clamp the head.

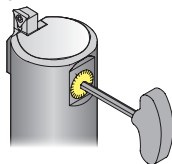

System

MODEL	Boring dia.
MFA20	$\phi 20 \sim 24.5$
MFA24	$\phi 24 \sim 30$
MFA29	$\phi 29 \sim 38$
MFA36	$\phi 36 \sim 52$
MFA50	$\phi 50 \sim 77$
MFA75	$\phi 75 \sim 102$

Available for spindle-through coolant as standard.



Adjustable effective length

Using the extension allows for increased effective length

MODEL	Length (mm)
MFA20	30 · 35 · 40 · 45
MFA24	
MFA29	30 · 40 · 50 · 60
MFA36	40 · 50 · 60 · 70
MFA50	45 · 60 · 75 · 90
MFA75	



Finishing and heavy duty boring holder **MBH**

Sliding rack design ... Wide adjusting range

The micro head, MBH provides a wide adjusting range and secure clamping by making use of the sliding rack design for fine adjustment in combination with dovetail clamping capability.

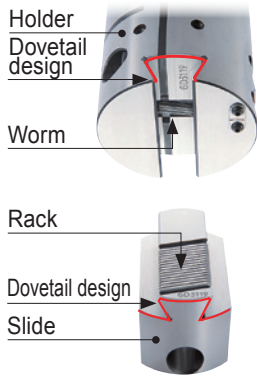

Dovetail clamping ... High rigidity and accuracy

The dovetail clamping capability holds the slide portion firmly without needing to change the setting diameter when clamping the slide. It is ideal for high-rigidity, high-accuracy boring applications.

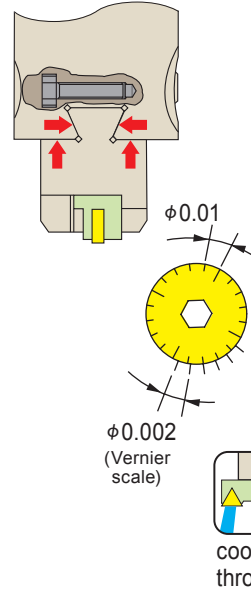

System

MODEL	Boring dia.
MBH 50	φ 50 ~ 80
MBH 75	φ 75 ~ 120
MBH115	φ 115 ~ 185
MBH180	φ 180 ~ 250
MBH245	φ 245 ~ 315
MBH310	φ 310 ~ 380



Wide range and multi-purpose boring holder **MBJ**

The combination of two kinds of boring bars allows for a wide range of boring applications from 5.5mm to 205mm dia.

MBJ45

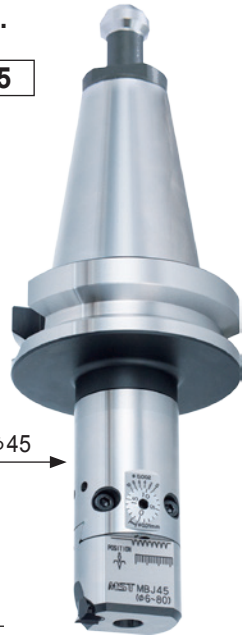

MBJ70

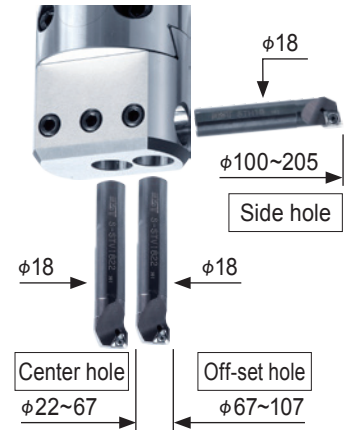

Cutting data

Micro Head for engraving

If you would like more detailed information, please contact MST and ask for a catalog.



MICRO HEAD MFA type (MFA)

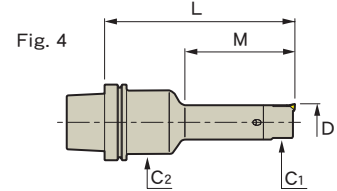
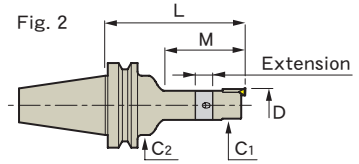
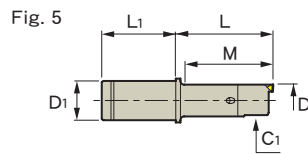
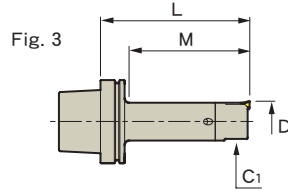
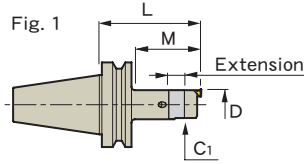

CODE	Fig.	Boring dia. (φD)	L	M	φC1	φC2	Extension	Kg					
BT30-MFA20- 90	1	20~ 24.5	90	63	19	—	—	0.6					
-MFA24- 90		24~ 30			22								
-MFA29-105		29~ 38	105	78	27.6								
-MFA36-105					36~ 52				34.4				
BT40-MFA20-120	2	20~ 24.5	120	65	19	46	—	1.4					
-150			150	81	—			1.5					
-MFA24-150		24~ 30	—	—	62			22	1.7				
-180					180			92	30	1.8			
-MFA29-150		29~ 38	150	82	27.6			—	1.7				
-180									180	112	30	1.8	
-MFA36-150		36~ 52	150	97	34.4			62	—	1.9			
-195										195	142	45	2.2
-MFA50-150		50~ 77	150	102	46			—	—	2.4			
-195										195	147	45	3.0
-MFA75-150		75~ 102	150	102	51			—	—	2.5			
-195										195	147	45	3.1
BT50-MFA20-165		2	20~ 24.5	165	54			19	62	—	4.9		
-195				195	84			—			5.0		
-240	240			64	—	6.3							
-MFA24-165	24~ 30			165	52	22	4.9						
-195			195				82	30			5.0		
-240	240		62	—	—	6.3							
-270						270	92	30			6.4		
-MFA29-165	29~ 38		165	82	27.6	70	—	4.7					
-195								195			112	30	4.8
-240								240			82	—	6.7
-270								270			112	30	6.9
-MFA36-165	36~ 52		165	97	34.4	—	—	4.6					
-210								210			142	45	4.9
-255								255			97	80	7.9
-300		300						142	45	8.2			
-MFA50-165	1	50~ 77	165	122	46	—	4.9						
-210							210	167	45	5.5			
-255							2	255	147	86	7.6		
-300								300	192	45	8.2		
-MFA75-165	1	75~ 102	165	122	51	—	5.0						
-210							210	167	45	5.6			
-255							2	255	147	86	7.7		
-300								300	192	45	8.3		

Extension

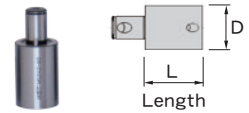

CODE	Applicable head	φD	L	Kg
MS0-30	MFA20	19	30	0.1
-35			35	0.1
-40			40	0.1
-45			45	0.1
MS1-30	MFA24	22	30	0.1
-35			35	0.1
-40			40	0.1
-45			45	0.1
MS2-30	MFA29	27.6	30	0.1
-40			40	0.2
-50			50	0.2
-60			60	0.3
MS3-40	MFA36	34.4	40	0.3
-45			45	0.3
-50			50	0.3
-70			70	0.5
MS4-45	MFA50 MFA75	46	45	0.6
-60			60	0.7
-75			75	0.9
-90			90	1.1

Caution

- Longer projection length causes chattering and reduced rigidity

Insert



CODE	R	Insert material	Q'ty	Work material
TPA082-PA	0.2	Cermet	10pcs.	Steel
TPA084-PA	0.4			
TPA082-MA	0.2			
TPA084-MA	0.4	Carbide	—	Stainless
TPA082-KA	0.2			
TPA084-KA	0.4			
TPA082-NA	0.2	Polycrystalline diamond	1pc.	Aluminum
TPA084-NA	0.4			
TPA082-ND	0.2			
TPA084-ND	0.4			

CODE	Fig.	Boring dia. (ϕ D)	L	M	ϕ C1	ϕ C2	Extension	D1	L1	 Kg						
A40 -MFA20- 90 -MFA24- 90 -MFA29-105 -MFA36-105 -MFA50-105	3	20~ 24.5	90	65	19	—	—	—	—	0.4						
		24~ 30			22											
		29~ 38	105	82	27.6											
		36~ 52			34.4											
		50~ 77			46											
A50 -MFA20-120 -MFA24-120 -MFA29-120 -MFA36-120 -MFA50-120 -MFA75-120	4	20~ 24.5	120	69	19	41	—	—	—	0.8						
		24~ 30			22											
		29~ 38			82											
	3	36~ 52	91	34.4	—					—	—	—	—	1.1		
		50~ 77		46										1.6		
		75~102		51										1.7		
A63 -MFA20-150 -MFA24-150 -180 -MFA29-150 -180 -MFA36-150 -195 -MFA50-150 -195 -MFA75-150 -195	4	20~ 24.5	150	81	19	46	—	—	—	1.3						
		24~ 30		62						22	1.5					
			180	92							30	1.6				
		29~ 38	150	82	27.6						—	1.5				
			180	112							30	1.6				
		36~ 52	150	97	34.4					52	—	1.7				
			195	142							45	2.0				
		50~ 77	150	102	46						—	2.2				
			195	147							45	2.7				
		75~102	150	102	51						—	2.3				
			195	147							45	2.8				
		A100 -MFA20-165 -195 -240 -MFA24-165 -195 -240 -270 -MFA29-165 -195 -240 -270 -MFA36-165 -210 -255 -300 -MFA50-165 -210 -255 -300 -MFA75-165 -210 -255 -300	4	20~ 24.5	165					54	19	62	—	—	—	3.8
					195					84						
240	64					—	5.3									
24~ 30	165			52	22		3.8									
	195			82		30	3.9									
	240			62		—	5.4									
270	92				30	5.5										
29~ 38	165			82	27.6	70	—	3.7								
	195			112			30	3.8								
	240			82			—	5.8								
	270		112		30		6.0									
36~ 52	165		97	34.4	80	—	3.7									
	210		142			45	4.0									
	255		97			—	7.2									
	300		142			45	7.5									
	3		50~ 77	165		131	46	—	3.6							
				210		176			45	4.2						
4				255	147	85		—	6.7							
	300		192		45		7.3									
3	75~102		165	131	51	—	3.7									
		210	176			45	4.3									
		4	255	147		85	—	6.8								
			300	192				45	7.4							
F63 -MFA20-150 -MFA24-150 -180 -MFA29-150 -180 -MFA36-150 -195 -MFA50-150 -195	4	20~ 24.5	150	81	19	46	—	—	—	1.3						
		24~ 30		62						22	1.5					
			180	92							30	1.6				
		29~ 38	150	82	27.6						—	1.5				
			180	112							30	1.6				
		36~ 52	150	97	34.4					52	—	1.7				
			195	142							45	2.0				
		50~ 77	150	102	46						—	2.2				
			195	147							45	2.7				
		ST25T -MFA20- 75 -MFA24- 90 -MFA29-105	5	20~ 24.5	75					75	19	—	—	25	70	—
24~ 30	90			85	22											
29~ 38	105			105	27.6											
S 32 -MFA20- 90 -MFA24- 90 -MFA29-105 -MFA36-105 -MFA50-105	5	20~ 24.5	90	75	19	—	—	32	70	—						
		24~ 30			80						22					
		29~ 38	105	95	27.6											
		36~ 52			34.4											
		50~ 77			46											

■Option

- Insert •Retention knob (BT) →P.64

■Std. Access.

- T wrench •Insert clamping screw •Coolant duct(Fixed)(HSK-A)→P.104
- Torx wrench

■Note

- Swing type coolant ducts are available upon request. For details, please contact us.
- Drive key slot and cutting direction are in alignment.
- The extension mentioned in the list is set between shank and head. The number refers to the extension length.



MICRO HEAD MBH type (MBH)



BT50-MBH180-225



A100-MBH75-165

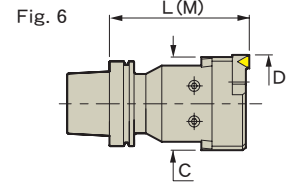
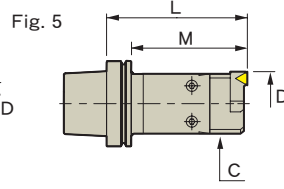
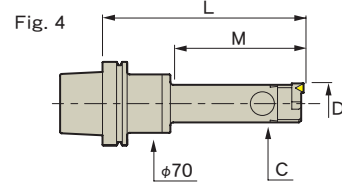
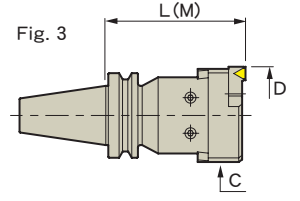
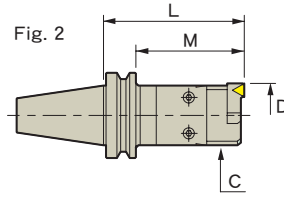
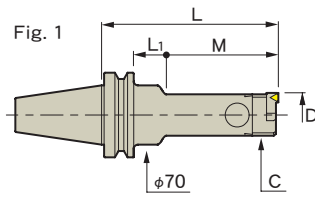

CODE	Fig.	Boring dia. (φD)	L	M	φC	L ₁	Cartridge	Kg
BT40-MBH 50-150	2	50~ 80	150	118	45	—	PTC 10	2.1
-210	1		210	155		28	STGP10	3.0
-MBH 75-165	3	75~120	165	165	70	—	PTC 12 STGP12	4.0
-MBH115-165		115~185			110			5.9
-MBH180-165		180~250			153			6.6
BT50-MBH 50-150	2	50~ 80	150	107	45	—	PTC 10 STGP10	4.5
-180			180	137				5.6
-240	1		240	155		47		6.3
-300			300			107		7.0
-MBH 75-165	3	75~120	165	127	70	—	PTC 12 STGP12	6.7
-225			225	187				8.5
-285			285	247				10.3
-315			315	277				11.2
-MBH115-165		115~185	165	165	110			8.6
-225			225	225			10.4	
-285			285	285			12.2	
-315			315	315			13.1	
-MBH180-165		180~250	165	165	153		9.3	
-225			225	225			11.1	
-285			285	285			12.9	
-MBH245-165		245~315	165	165	200		10.0	
-225			225	225			11.8	
-285			285	285			13.6	
-MBH310-165		310~380	165	165	255		11.0	
-225			225	225			12.8	
A50M-MBH 50-135	5	50~ 80	135	109	45	—	PTC10/STGP10	1.6
-MBH 75-175		75~120	175	149	70		PTC12/STGP12	3.4
A63 -MBH 50-150	5	50~ 80	150	119	45	—	PTC 10 STGP10	1.9
-210			210	179				2.6
-MBH 75-195	6	75~120	195	195	70		PTC 12 STGP12	4.5
-MBH115-195		115~185			110			6.5
-MBH180-195		180~250			153			7.2
A100-MBH 50-150	5	50~ 80	150	116	45	—	PTC 10 STGP10	3.3
-180			180	146				3.6
-240	4		240	155		56		5.2
-300			300			116		6.8
-MBH 75-165	6	75~120	165	131	70	—	PTC 12 STGP12	5.3
-225			225	191				6.9
-285			285	251				8.6
-315			315	281				9.4

CODE	Fig.	Boring dia. (φD)	L	M	φC	L ₁	Cartridge	Kg
A100-MBH115-165	4	115~185	165	165	110	—	PTC 12 STGP12	7.2
-225			225	225				8.9
-285			285	285				10.5
-315			315	315				11.4
-MBH180-165		180~250	165	165	153			7.9
-225			225	225				9.6
-285			285	285				11.2
-MBH245-165		245~315	165	165	200			8.7
-225			225	225				10.3
-285			285	285				12.0
-MBH310-165		310~380	165	165	255			9.6
-225			225	225				11.2



Option

- Insert • Cartridge • Coolant-through • Retention knob(BT)→P.64

Std. Access.

- T wrench • Coolant duct(Fixed) (HSK-A)→P.104

Note

- Swing type coolant ducts are available upon request. For details, please contact us.
- Drive key slot and cutting direction are in alignment.
- Add "C" after the MBH model no. for through-spindle coolant when you order. (Example: BT50-MBH75C-165)

Caution

- Each slide part is produced to match precisely with its corresponding slide, so such parts are not interchangeable with each other.
- The undercut area of the A50M is different from the standards. Please be careful to check for interference with the ATC arm.



Cartridge

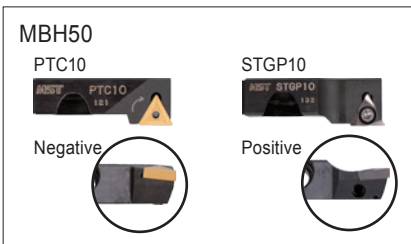

CODE	Work-piece material	Holder type
PTC10	Steel·Cast Iron·Stainless	MBH50
STGP10	Steel·Cast Iron Stainless·Aluminum	
PTC12	Steel·Cast Iron	MBH75 ~310
STGP12	Steel·Cast Iron Stainless·Aluminum	

Note

- PTC : Pin lock type
- STGP: Clamp-on type

Insert

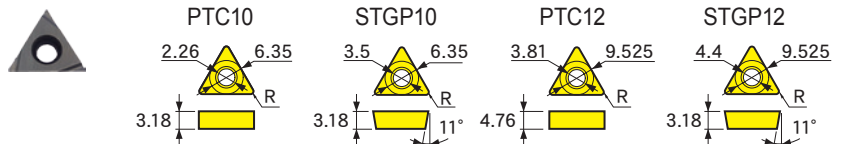

CODE	R	Insert material	Work-piece material	Application	Q'ty	Cartridge	
TNB114-PB	0.4	Carbide coating	Steel	Semi-finishing	10pcs.	PTC 10	
-MB		Carbide	Stainless				
-KB			Cast iron				
-PMA		Cermet	Steel·stainless	Finishing			
-KA	Carbide	Cast iron					
TPC112-PA	0.2	Cermet	Steel	Finishing	10pcs.	STGP10	
TPC114-PA	0.4						
TPC112-MA	0.2	Carbide	Stainless				
TPC114-MA			0.4				
TPC112-KA			0.2				Cast iron
TPC114-KA	0.4						
TPC112-NA	0.2		Aluminum				
TPC114-NA	0.4						
TPC112-ND	0.2	Polycrystalline diamond			1pc.		
TPC114-ND	0.4						
TNB168-PB	0.8	Carbide coating	Steel	Semi-finishing	10pcs.	PTC 12	
-MB			Stainless				
-KB		Carbide	Cast iron				
TNB164-PMA	0.4	Cermet	Steel·stainless	Finishing			
-KA		Carbide	Cast iron				
TPC164-PA	0.4	Cermet	Steel	Finishing	10pcs.	STGP12	
-MA		Carbide coating	Stainless				
-KA		Carbide	Cast iron				
-NA			Aluminum				
-ND		Polycrystalline diamond			1pc.		

MICRO HEAD MBJ45 type (MBJ45)



A100-MBJ45-150



S32-MBJ45-105

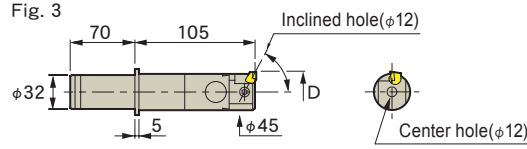
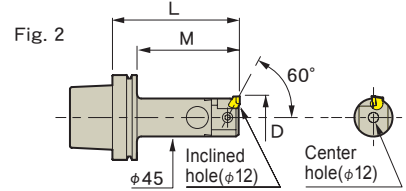
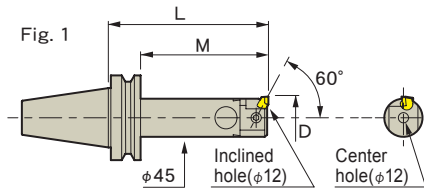

CODE	Fig.	Boring dia. (φD)	L	M	Kg
BT30-MBJ45-120	1	5.5~80	120	98	1.3
BT40-MBJ45-150	1	5.5~80	150	123	2.2
BT50-MBJ45-150	1	5.5~80	150	112	4.6
-180			180	142	5.6
A63 -MBJ45-150	2	5.5~80	150	124	2.0
A100-MBJ45-150	2	5.5~80	150	121	3.3
-180			180	151	3.7
S32 -MBJ45-105	3	5.5~80	—	—	—

- Option
- Insert + Insert holder
 - Insert and insert holder set
 - Retention knob (BT) → P.64
- Std. Access.
- Wrench set
 - Coolant duct (Fixed) (HSK-A) → P.104
- Note
- Swing type coolant ducts are available upon request. For details, please contact us.
 - Drive key slot and cutting direction are in alignment.

Insert holder, Insert

For center hole



Boring diameter φ5.5~8		Boring diameter φ8~10																																																																																																																																																																			
Insert holder	Insert	Insert holder	Insert																																																																																																																																																																		
<table border="1"> <thead> <tr> <th>CODE</th> <th>R</th> <th>Insert material</th> <th>Q'ty</th> <th>Work material</th> </tr> </thead> <tbody> <tr> <td>STV-C12055</td> <td>0.2</td> <td>Cermet</td> <td>10pcs.</td> <td>Steel</td> </tr> <tr> <td rowspan="3">Carbide shank</td> <td></td> <td>Carbide coating</td> <td></td> <td>Stainless</td> </tr> <tr> <td></td> <td>Cast iron</td> <td></td> <td>Aluminum</td> </tr> <tr> <td></td> <td>Carbide</td> <td></td> <td></td> </tr> </tbody> </table>	CODE	R	Insert material	Q'ty	Work material	STV-C12055	0.2	Cermet	10pcs.	Steel	Carbide shank		Carbide coating		Stainless		Cast iron		Aluminum		Carbide			<table border="1"> <thead> <tr> <th>CODE</th> <th>R</th> <th>Insert material</th> <th>Q'ty</th> <th>Work material</th> </tr> </thead> <tbody> <tr> <td>TPE042-PA</td> <td>0.2</td> <td>Cermet</td> <td>10pcs.</td> <td>Steel</td> </tr> <tr> <td>-MKA</td> <td></td> <td>Carbide coating</td> <td></td> <td>Stainless</td> </tr> <tr> <td>-NA</td> <td></td> <td>Carbide</td> <td></td> <td>Aluminum</td> </tr> </tbody> </table>	CODE	R	Insert material	Q'ty	Work material	TPE042-PA	0.2	Cermet	10pcs.	Steel	-MKA		Carbide coating		Stainless	-NA		Carbide		Aluminum	<table border="1"> <thead> <tr> <th>CODE</th> <th>R</th> <th>Insert material</th> <th>Q'ty</th> <th>Work material</th> </tr> </thead> <tbody> <tr> <td>STV-C1208</td> <td>0.2</td> <td>Cermet</td> <td>10pcs.</td> <td>Steel</td> </tr> <tr> <td rowspan="5">Carbide shank</td> <td></td> <td>Carbide coating</td> <td></td> <td>Stainless</td> </tr> <tr> <td></td> <td>Cast iron</td> <td></td> <td>Aluminum</td> </tr> <tr> <td></td> <td>Carbide</td> <td></td> <td></td> </tr> <tr> <td></td> <td>Carbide</td> <td></td> <td></td> </tr> <tr> <td></td> <td>Carbide</td> <td></td> <td></td> </tr> </tbody> </table>	CODE	R	Insert material	Q'ty	Work material	STV-C1208	0.2	Cermet	10pcs.	Steel	Carbide shank		Carbide coating		Stainless		Cast iron		Aluminum		Carbide				Carbide				Carbide			<table border="1"> <thead> <tr> <th>CODE</th> <th>R</th> <th>Insert material</th> <th>Q'ty</th> <th>Work material</th> </tr> </thead> <tbody> <tr> <td>TPE032-PA</td> <td>0.2</td> <td>Cermet</td> <td>10pcs.</td> <td>Steel</td> </tr> <tr> <td>TPE034-PA</td> <td>0.4</td> <td></td> <td></td> <td></td> </tr> <tr> <td>TPE032-MKA</td> <td>0.2</td> <td>Carbide coating</td> <td></td> <td>Stainless</td> </tr> <tr> <td>TPE034-MKA</td> <td>0.4</td> <td></td> <td></td> <td>Cast iron</td> </tr> <tr> <td>TPE032-NA</td> <td>0.2</td> <td>Carbide</td> <td></td> <td>Aluminum</td> </tr> <tr> <td>TPE034-NA</td> <td>0.4</td> <td></td> <td></td> <td></td> </tr> </tbody> </table>	CODE	R	Insert material	Q'ty	Work material	TPE032-PA	0.2	Cermet	10pcs.	Steel	TPE034-PA	0.4				TPE032-MKA	0.2	Carbide coating		Stainless	TPE034-MKA	0.4			Cast iron	TPE032-NA	0.2	Carbide		Aluminum	TPE034-NA	0.4																																																								
CODE	R	Insert material	Q'ty	Work material																																																																																																																																																																	
STV-C12055	0.2	Cermet	10pcs.	Steel																																																																																																																																																																	
Carbide shank		Carbide coating		Stainless																																																																																																																																																																	
		Cast iron		Aluminum																																																																																																																																																																	
		Carbide																																																																																																																																																																			
CODE	R	Insert material	Q'ty	Work material																																																																																																																																																																	
TPE042-PA	0.2	Cermet	10pcs.	Steel																																																																																																																																																																	
-MKA		Carbide coating		Stainless																																																																																																																																																																	
-NA		Carbide		Aluminum																																																																																																																																																																	
CODE	R	Insert material	Q'ty	Work material																																																																																																																																																																	
STV-C1208	0.2	Cermet	10pcs.	Steel																																																																																																																																																																	
Carbide shank		Carbide coating		Stainless																																																																																																																																																																	
		Cast iron		Aluminum																																																																																																																																																																	
		Carbide																																																																																																																																																																			
		Carbide																																																																																																																																																																			
		Carbide																																																																																																																																																																			
CODE	R	Insert material	Q'ty	Work material																																																																																																																																																																	
TPE032-PA	0.2	Cermet	10pcs.	Steel																																																																																																																																																																	
TPE034-PA	0.4																																																																																																																																																																				
TPE032-MKA	0.2	Carbide coating		Stainless																																																																																																																																																																	
TPE034-MKA	0.4			Cast iron																																																																																																																																																																	
TPE032-NA	0.2	Carbide		Aluminum																																																																																																																																																																	
TPE034-NA	0.4																																																																																																																																																																				
<table border="1"> <thead> <tr> <th>CODE</th> <th>R</th> <th>Insert material</th> <th>Q'ty</th> <th>Work material</th> </tr> </thead> <tbody> <tr> <td>STV-C1210</td> <td>0.2</td> <td>Cermet</td> <td>10pcs.</td> <td>Steel</td> </tr> <tr> <td rowspan="6">Carbide shank</td> <td></td> <td>Carbide coating</td> <td></td> <td>Stainless</td> </tr> <tr> <td></td> <td>Cast iron</td> <td></td> <td>Aluminum</td> </tr> <tr> <td></td> <td>Carbide</td> <td></td> <td></td> </tr> <tr> <td></td> <td>Carbide</td> <td></td> <td></td> </tr> <tr> <td></td> <td>Carbide</td> <td></td> <td></td> </tr> <tr> <td></td> <td>Carbide</td> <td></td> <td></td> </tr> </tbody> </table>	CODE	R	Insert material	Q'ty	Work material	STV-C1210	0.2	Cermet	10pcs.	Steel	Carbide shank		Carbide coating		Stainless		Cast iron		Aluminum		Carbide				Carbide				Carbide				Carbide			<table border="1"> <thead> <tr> <th>CODE</th> <th>R</th> <th>Insert material</th> <th>Q'ty</th> <th>Work material</th> </tr> </thead> <tbody> <tr> <td>TPE082-PA</td> <td>0.2</td> <td>Cermet</td> <td>10pcs.</td> <td>Steel</td> </tr> <tr> <td>TPE084-PA</td> <td>0.4</td> <td></td> <td></td> <td></td> </tr> <tr> <td>TPE082-MA</td> <td>0.2</td> <td>Carbide coating</td> <td></td> <td>Stainless</td> </tr> <tr> <td>TPE084-MA</td> <td>0.4</td> <td></td> <td></td> <td>Cast iron</td> </tr> <tr> <td>TPE082-KNA</td> <td>0.2</td> <td>Carbide</td> <td></td> <td>Aluminum</td> </tr> <tr> <td>TPE084-KNA</td> <td>0.4</td> <td></td> <td></td> <td></td> </tr> </tbody> </table>	CODE	R	Insert material	Q'ty	Work material	TPE082-PA	0.2	Cermet	10pcs.	Steel	TPE084-PA	0.4				TPE082-MA	0.2	Carbide coating		Stainless	TPE084-MA	0.4			Cast iron	TPE082-KNA	0.2	Carbide		Aluminum	TPE084-KNA	0.4				<table border="1"> <thead> <tr> <th>CODE</th> <th>R</th> <th>Insert material</th> <th>Q'ty</th> <th>Work material</th> </tr> </thead> <tbody> <tr> <td>STV-C1212</td> <td>0.2</td> <td>Cermet</td> <td>10pcs.</td> <td>Steel</td> </tr> <tr> <td rowspan="6">Carbide shank</td> <td></td> <td>Carbide coating</td> <td></td> <td>Stainless</td> </tr> <tr> <td></td> <td>Cast iron</td> <td></td> <td>Aluminum</td> </tr> <tr> <td></td> <td>Carbide</td> <td></td> <td></td> </tr> <tr> <td></td> <td>Carbide</td> <td></td> <td></td> </tr> <tr> <td></td> <td>Carbide</td> <td></td> <td></td> </tr> <tr> <td></td> <td>Carbide</td> <td></td> <td></td> </tr> </tbody> </table>	CODE	R	Insert material	Q'ty	Work material	STV-C1212	0.2	Cermet	10pcs.	Steel	Carbide shank		Carbide coating		Stainless		Cast iron		Aluminum		Carbide				Carbide				Carbide				Carbide			<table border="1"> <thead> <tr> <th>CODE</th> <th>R</th> <th>Insert material</th> <th>Q'ty</th> <th>Work material</th> </tr> </thead> <tbody> <tr> <td>TPE112-PA</td> <td>0.2</td> <td>Cermet</td> <td>10pcs.</td> <td>Steel</td> </tr> <tr> <td>TPE114-PA</td> <td>0.4</td> <td></td> <td></td> <td></td> </tr> <tr> <td>TPE112-MA</td> <td>0.2</td> <td>Carbide coating</td> <td></td> <td>Stainless</td> </tr> <tr> <td>TPE114-MA</td> <td>0.4</td> <td></td> <td></td> <td>Cast iron</td> </tr> <tr> <td>TPE112-KNA</td> <td>0.2</td> <td>Carbide</td> <td></td> <td>Aluminum</td> </tr> <tr> <td>TPE114-KNA</td> <td>0.4</td> <td></td> <td></td> <td></td> </tr> </tbody> </table>	CODE	R	Insert material	Q'ty	Work material	TPE112-PA	0.2	Cermet	10pcs.	Steel	TPE114-PA	0.4				TPE112-MA	0.2	Carbide coating		Stainless	TPE114-MA	0.4			Cast iron	TPE112-KNA	0.2	Carbide		Aluminum	TPE114-KNA	0.4																									
CODE	R	Insert material	Q'ty	Work material																																																																																																																																																																	
STV-C1210	0.2	Cermet	10pcs.	Steel																																																																																																																																																																	
Carbide shank		Carbide coating		Stainless																																																																																																																																																																	
		Cast iron		Aluminum																																																																																																																																																																	
		Carbide																																																																																																																																																																			
		Carbide																																																																																																																																																																			
		Carbide																																																																																																																																																																			
		Carbide																																																																																																																																																																			
CODE	R	Insert material	Q'ty	Work material																																																																																																																																																																	
TPE082-PA	0.2	Cermet	10pcs.	Steel																																																																																																																																																																	
TPE084-PA	0.4																																																																																																																																																																				
TPE082-MA	0.2	Carbide coating		Stainless																																																																																																																																																																	
TPE084-MA	0.4			Cast iron																																																																																																																																																																	
TPE082-KNA	0.2	Carbide		Aluminum																																																																																																																																																																	
TPE084-KNA	0.4																																																																																																																																																																				
CODE	R	Insert material	Q'ty	Work material																																																																																																																																																																	
STV-C1212	0.2	Cermet	10pcs.	Steel																																																																																																																																																																	
Carbide shank		Carbide coating		Stainless																																																																																																																																																																	
		Cast iron		Aluminum																																																																																																																																																																	
		Carbide																																																																																																																																																																			
		Carbide																																																																																																																																																																			
		Carbide																																																																																																																																																																			
		Carbide																																																																																																																																																																			
CODE	R	Insert material	Q'ty	Work material																																																																																																																																																																	
TPE112-PA	0.2	Cermet	10pcs.	Steel																																																																																																																																																																	
TPE114-PA	0.4																																																																																																																																																																				
TPE112-MA	0.2	Carbide coating		Stainless																																																																																																																																																																	
TPE114-MA	0.4			Cast iron																																																																																																																																																																	
TPE112-KNA	0.2	Carbide		Aluminum																																																																																																																																																																	
TPE114-KNA	0.4																																																																																																																																																																				
<table border="1"> <thead> <tr> <th>CODE</th> <th>R</th> <th>Insert material</th> <th>Q'ty</th> <th>Work material</th> </tr> </thead> <tbody> <tr> <td>STV-C1214</td> <td>0.2</td> <td>Cermet</td> <td>10pcs.</td> <td>Steel</td> </tr> <tr> <td rowspan="6">Carbide shank</td> <td></td> <td>Carbide coating</td> <td></td> <td>Stainless</td> </tr> <tr> <td></td> <td>Cast iron</td> <td></td> <td>Aluminum</td> </tr> <tr> <td></td> <td>Carbide</td> <td></td> <td></td> </tr> <tr> <td></td> <td>Carbide</td> <td></td> <td></td> </tr> <tr> <td></td> <td>Carbide</td> <td></td> <td></td> </tr> <tr> <td></td> <td>Carbide</td> <td></td> <td></td> </tr> </tbody> </table>	CODE	R	Insert material	Q'ty	Work material	STV-C1214	0.2	Cermet	10pcs.	Steel	Carbide shank		Carbide coating		Stainless		Cast iron		Aluminum		Carbide				Carbide				Carbide				Carbide			<table border="1"> <thead> <tr> <th>CODE</th> <th>R</th> <th>Insert material</th> <th>Q'ty</th> <th>Work material</th> </tr> </thead> <tbody> <tr> <td>TPE112-PA</td> <td>0.2</td> <td>Cermet</td> <td>10pcs.</td> <td>Steel</td> </tr> <tr> <td>TPE114-PA</td> <td>0.4</td> <td></td> <td></td> <td></td> </tr> <tr> <td>TPE112-MA</td> <td>0.2</td> <td>Carbide coating</td> <td></td> <td>Stainless</td> </tr> <tr> <td>TPE114-MA</td> <td>0.4</td> <td></td> <td></td> <td>Cast iron</td> </tr> <tr> <td>TPE112-KNA</td> <td>0.2</td> <td>Carbide</td> <td></td> <td>Aluminum</td> </tr> <tr> <td>TPE114-KNA</td> <td>0.4</td> <td></td> <td></td> <td></td> </tr> </tbody> </table>	CODE	R	Insert material	Q'ty	Work material	TPE112-PA	0.2	Cermet	10pcs.	Steel	TPE114-PA	0.4				TPE112-MA	0.2	Carbide coating		Stainless	TPE114-MA	0.4			Cast iron	TPE112-KNA	0.2	Carbide		Aluminum	TPE114-KNA	0.4				<table border="1"> <thead> <tr> <th>CODE</th> <th>R</th> <th>Insert material</th> <th>Q'ty</th> <th>Work material</th> </tr> </thead> <tbody> <tr> <td>STV1216</td> <td>0.2</td> <td>Cermet</td> <td>10pcs.</td> <td>Steel</td> </tr> <tr> <td rowspan="9">Steel shank</td> <td></td> <td>Carbide</td> <td></td> <td>Stainless</td> </tr> <tr> <td></td> <td>Cast iron</td> <td></td> <td>Aluminum</td> </tr> <tr> <td></td> <td>Polycrystalline diamond</td> <td>1pc.</td> <td>Aluminum</td> </tr> <tr> <td></td> <td>Carbide</td> <td></td> <td></td> </tr> <tr> <td></td> <td>Carbide</td> <td></td> <td></td> </tr> <tr> <td></td> <td>Carbide</td> <td></td> <td></td> </tr> <tr> <td></td> <td>Carbide</td> <td></td> <td></td> </tr> <tr> <td></td> <td>Carbide</td> <td></td> <td></td> </tr> <tr> <td></td> <td>Carbide</td> <td></td> <td></td> </tr> </tbody> </table>	CODE	R	Insert material	Q'ty	Work material	STV1216	0.2	Cermet	10pcs.	Steel	Steel shank		Carbide		Stainless		Cast iron		Aluminum		Polycrystalline diamond	1pc.	Aluminum		Carbide				Carbide				Carbide				Carbide				Carbide				Carbide			<table border="1"> <thead> <tr> <th>CODE</th> <th>R</th> <th>Insert material</th> <th>Q'ty</th> <th>Work material</th> </tr> </thead> <tbody> <tr> <td>TPC092-PA</td> <td>0.2</td> <td>Cermet</td> <td>10pcs.</td> <td>Steel</td> </tr> <tr> <td>TPC094-PA</td> <td>0.4</td> <td></td> <td></td> <td></td> </tr> <tr> <td>TPC092-MA</td> <td>0.2</td> <td>Carbide</td> <td></td> <td>Stainless</td> </tr> <tr> <td>TPC094-MA</td> <td>0.4</td> <td></td> <td></td> <td>Cast iron</td> </tr> <tr> <td>TPC092-KNA</td> <td>0.2</td> <td>Carbide</td> <td></td> <td>Aluminum</td> </tr> <tr> <td>TPC094-KNA</td> <td>0.4</td> <td></td> <td></td> <td></td> </tr> <tr> <td>TPC092-ND</td> <td>0.2</td> <td>Polycrystalline diamond</td> <td>1pc.</td> <td>Aluminum</td> </tr> <tr> <td>TPC094-ND</td> <td>0.4</td> <td></td> <td></td> <td></td> </tr> </tbody> </table>	CODE	R	Insert material	Q'ty	Work material	TPC092-PA	0.2	Cermet	10pcs.	Steel	TPC094-PA	0.4				TPC092-MA	0.2	Carbide		Stainless	TPC094-MA	0.4			Cast iron	TPC092-KNA	0.2	Carbide		Aluminum	TPC094-KNA	0.4				TPC092-ND	0.2	Polycrystalline diamond	1pc.	Aluminum	TPC094-ND	0.4			
CODE	R	Insert material	Q'ty	Work material																																																																																																																																																																	
STV-C1214	0.2	Cermet	10pcs.	Steel																																																																																																																																																																	
Carbide shank		Carbide coating		Stainless																																																																																																																																																																	
		Cast iron		Aluminum																																																																																																																																																																	
		Carbide																																																																																																																																																																			
		Carbide																																																																																																																																																																			
		Carbide																																																																																																																																																																			
		Carbide																																																																																																																																																																			
CODE	R	Insert material	Q'ty	Work material																																																																																																																																																																	
TPE112-PA	0.2	Cermet	10pcs.	Steel																																																																																																																																																																	
TPE114-PA	0.4																																																																																																																																																																				
TPE112-MA	0.2	Carbide coating		Stainless																																																																																																																																																																	
TPE114-MA	0.4			Cast iron																																																																																																																																																																	
TPE112-KNA	0.2	Carbide		Aluminum																																																																																																																																																																	
TPE114-KNA	0.4																																																																																																																																																																				
CODE	R	Insert material	Q'ty	Work material																																																																																																																																																																	
STV1216	0.2	Cermet	10pcs.	Steel																																																																																																																																																																	
Steel shank		Carbide		Stainless																																																																																																																																																																	
		Cast iron		Aluminum																																																																																																																																																																	
		Polycrystalline diamond	1pc.	Aluminum																																																																																																																																																																	
		Carbide																																																																																																																																																																			
		Carbide																																																																																																																																																																			
		Carbide																																																																																																																																																																			
		Carbide																																																																																																																																																																			
		Carbide																																																																																																																																																																			
		Carbide																																																																																																																																																																			
CODE	R	Insert material	Q'ty	Work material																																																																																																																																																																	
TPC092-PA	0.2	Cermet	10pcs.	Steel																																																																																																																																																																	
TPC094-PA	0.4																																																																																																																																																																				
TPC092-MA	0.2	Carbide		Stainless																																																																																																																																																																	
TPC094-MA	0.4			Cast iron																																																																																																																																																																	
TPC092-KNA	0.2	Carbide		Aluminum																																																																																																																																																																	
TPC094-KNA	0.4																																																																																																																																																																				
TPC092-ND	0.2	Polycrystalline diamond	1pc.	Aluminum																																																																																																																																																																	
TPC094-ND	0.4																																																																																																																																																																				

For inclined hole

S-STA12

Boring diameter $\phi 48 \sim 80$					
Insert holder		Insert			
CODE	CODE	R	Insert material	Q'ty	Work material
S-STA12	TPC112-PA	0.2	Cermet	10pcs.	Steel
	TPC114-PA	0.4			
	TPC112-MA	0.2	Carbide		Stainless
	TPC114-MA	0.4			
	TPC112-KA	0.2	Cast iron		
	TPC114-KA	0.4			
	TPC112-NA	0.2	Aluminum		
	TPC114-NA	0.4			
	TPC112-ND	0.2	Polycrystalline diamond		1pc.
	TPC114-ND	0.4			

Steel shank

3.5 6.35
t = 3.18

Insert and insert holder set

CODE	Insert holder	Q'ty	Insert	Q'ty	Work material
PJ-45	STV1216	1pc.	TPC094-PA	10pcs.	Steel
	S-STA12		TPC114-PA		
KJ-45	STV1216	1pc.	TPC094-KNA	10pcs.	Cast iron Aluminum
	S-STA12		TPC114-KA		

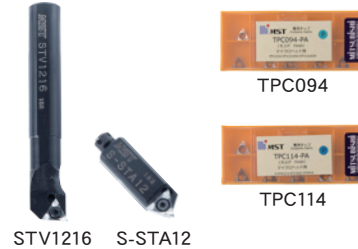

MICRO HEAD MBJ70 type (MBJ70)

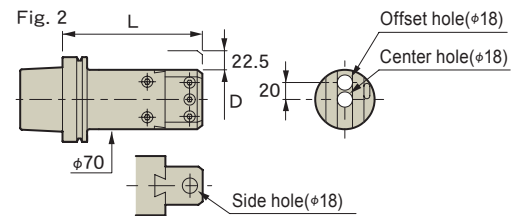
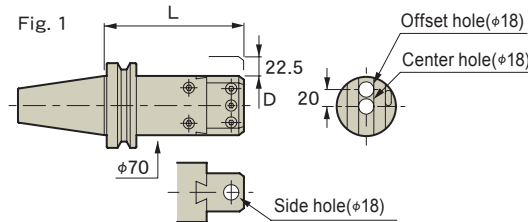

CODE	Fig.	Chucking range (ϕD)	L	Kg
BT40-MBJ70-165	1	22~205	165	4.2
BT50-MBJ70-165	1	22~205	165	6.5
A63-MBJ70-195	2	22~205	195	4.6
A100-MBJ70-165	2	22~205	165	5.4

Option

- Insert • Insert holder • Insert and insert holder set
- Clamping sleeve • Retention knob (BT) → P.64

Std. Access.

- Wrench set • Coolant duct (Fixed) (HSK-A) → P.104

Note

- Swing type coolant ducts are available upon request. For details, please contact us.
- Drive key slot and insertion direction are in alignment.
- The throw-away insert for aluminum is a diamond insert. Sales unit is per 1 piece.

Insert holder, Insert

For center hole · inclined hole

S-STV1822

Boring diameter $\phi 22 \sim 107$					
Insert holder		Insert			
CODE	CODE	R	Insert material	Q'ty	Work material
S-STV1822	TPC112-PA	0.2	Cermet	10pcs.	Steel
	TPC114-PA	0.4			
	TPC112-MA	0.2	Carbide		Stainless
	TPC114-MA	0.4			
	TPC112-KA	0.2	Cast iron		
	TPC114-KA	0.4			
	TPC112-NA	0.2	Aluminum		
	TPC114-NA	0.4			
	TPC112-ND	0.2	Polycrystalline diamond		1pc.
	TPC114-ND	0.4			

Steel shank

Center hole $\phi 70$

Boring diameter $\phi 22 \sim 67$

Offset hole $\phi 70$

Boring diameter $\phi 67 \sim 107$

3.5 6.35
t = 3.18

For side hole

Boring diameter $\phi 100 \sim 205$

STH18

Insert holder		Insert			
CODE	CODE	R	Insert material	Q'ty	Work material
STH18	CCD094-PA	0.4	Carbide coating	10pcs.	Steel
	CCD094-MA				
	CCD094-KA	Carbide	Cast iron		
	CCD094-NA				
	CCD094-ND	Polycrystalline diamond	1pc.		Aluminum

Steel shank

4 A D

9.525 4.4
R t = 3.97

A	ϕD
15	100~145
35	140~185
45	160~205

Insert and insert holder set

CODE	Insert holder	Q'ty	Insert	Q'ty	Work material
PJ-70	S-STV1822	1pc.	TPC114-PA	10pcs.	Steel
	STH18		CCD094-PA		
KJ-70	S-STV1822	1pc.	TPC114-KA	10pcs.	Cast iron
	STH18		CCD094-KA		



Cutting data

MFA type

<p>S45C - Finishing - Insert : TPA084-PA (Nose R0.4)</p> <p>n 3317 min⁻¹ Vf 331 mm/min Vc 250 m/min f 0.1 mm/rev</p> <p>BT50-MFA24-270</p>	<p>SUS304 - Finishing - Insert : TPA084-MA (Nose R0.4)</p> <p>n 1326 min⁻¹ Vf 132 mm/min Vc 100 m/min f 0.1 mm/rev</p> <p>BT50-MFA24-240</p>	<p>FC250 - Finishing - Insert : TPA084-KA (Nose R0.4)</p> <p>n 636 min⁻¹ Vf 63 mm/min Vc 100 m/min f 0.1 mm/rev</p> <p>BT50-MFA50-300</p>	<p>A5056 - Finishing - Insert : TPA084-NA (Nose R0.4)</p> <p>n 3538 min⁻¹ Vf 353 mm/min Vc 400 m/min f 0.1 mm/rev</p> <p>BT50-MFA36-300</p>
--	--	---	---

MBH type

<p>S45C - Semi-finishing - Insert : TNB168-PB (Nose R0.8) Cartridge : PTC12</p> <p>n 575 min⁻¹ Vf 86 mm/min Vc 150 m/min f 0.15 mm/rev</p> <p>BT50-MBH75-315</p>	<p>SUS304 - Semi-finishing - Insert : TNB168-MB (Nose R0.8) Cartridge : PTC12</p> <p>n 383 min⁻¹ Vf 57 mm/min Vc 100 m/min f 0.15 mm/rev</p> <p>BT50-MBH75-315</p>	<p>FC250 - Semi-finishing - Insert : TNB168-KB (Nose R0.8) Cartridge : PTC12</p> <p>n 383 min⁻¹ Vf 57 mm/min Vc 100 m/min f 0.15 mm/rev</p> <p>BT50-MBH75-315</p>	<p>A5056 - Semi-finishing - Insert : TPC164-NA (Nose R0.4) Cartridge : STGP12</p> <p>n 806 min⁻¹ Vf 120 mm/min Vc 200 m/min f 0.15 mm/rev</p> <p>BT50-MBH75-315</p>
<p>S45C - Finishing - Insert : TPC164-PA (Nose R0.4) Cartridge : STGP12</p> <p>n 1057 min⁻¹ Vf 105 mm/min Vc 250 m/min f 0.1 mm/rev</p> <p>BT50-MBH75-315</p>	<p>SUS304 - Finishing - Insert : TPC164-MA (Nose R0.4) Cartridge : STGP12</p> <p>n 507 min⁻¹ Vf 50 mm/min Vc 120 m/min f 0.1 mm/rev</p> <p>BT50-MBH75-315</p>	<p>FC250 - Finishing - Insert : TPC164-KA (Nose R0.4) Cartridge : STGP12</p> <p>n 507 min⁻¹ Vf 50 mm/min Vc 120 m/min f 0.1 mm/rev</p> <p>BT50-MBH75-315</p>	<p>A5056 - Finishing - Insert : TPC164-NA (Nose R0.4) Cartridge : STGP12</p> <p>n 1693 min⁻¹ Vf 169 mm/min Vc 400 m/min f 0.1 mm/rev</p> <p>BT50-MBH75-315</p>

MBJ type

<p>S45C - Finishing - Insert : TPE032-PA (Nose R0.2) Insert holder : STV-C1208</p> <p>n 3107 min⁻¹ Vf 186 mm/min Vc 80 m/min f 0.06 mm/rev</p> <p>BT40-MBJ45-150</p>	<p>SUS304 - Finishing - Insert : TPE032-MKA (Nose R0.2) Insert holder : STV-C1208</p> <p>n 1165 min⁻¹ Vf 69 mm/min Vc 30 m/min f 0.06 mm/rev</p> <p>BT40-MBJ45-150</p>	<p>FC250 - Finishing - Insert : TPE032-MKA (Nose R0.2) Insert holder : STV-C1208</p> <p>n 3107 min⁻¹ Vf 186 mm/min Vc 80 m/min f 0.06 mm/rev</p> <p>BT40-MBJ45-150</p>	<p>A5056 - Finishing - Insert : TPE032-NA (Nose R0.2) Insert holder : STV-C1208</p> <p>n 6602 min⁻¹ Vf 396 mm/min Vc 170 m/min f 0.06 mm/rev</p> <p>BT40-MBJ45-150</p>
--	--	--	--

Retention knob



Caution

- Retention knobs in this catalog are typical models for various machine tool companies. Confirm the correct retention knob design refer to the machine specification sheet.
- We manufacture other kinds of retention knobs. Please contact us for the details.

Machine manufacturers	Standard type						For through spindle coolant type		
	BT30		BT40		BT50		BT30	BT40	BT50
	Standard	Standard type with a through hole	Standard	Standard type with a through hole	Standard	Standard type with a through hole			
OKUMA	-		P40T-2 (MB series)	P-339	P50T-2	P-419	-	P-499	P-419
			P40T-1 (MILLAC series)	P-297					
OKK	-		P40T-1	-	P-143	-	-	-	-
OHTORI	-		P40T-1	P-297	P50T-1	P-299	-	-	-
KITAMURA	P30T-1	P-445	P-348	P-323-1	P-400		-	P-323-1	P-400
	P-399(Mycenter-1Xi)								
KIRA	P30T-1	P-445	P40T-1	P-297	-		-	P-323-1	-
KIWA	P30T-1	P-445	P-348	P-323-1	P-400		-	P-323-1	P-400
KURASHIKI	-		P40T-1	P-297	P50T-1	P-299	-	-	-
KOMATSU NTC	P30T-1	P-445	P40T-1	P-297	P50T-1	P-299	P-522	P-505	P-384
JTEKT	-		P40T-1	P-297	P50T-1	P-299	-	P-297	P-299
SHIZUOKA	P30T-1	P-445	P-141	P-498	P-143	P-402	-	-	-
SNK	-		P40T-2	P-339	P50T-2	P-419	-	-	-
SUGINO	P30T-2	P-497	-		-		-	-	-
DMG MORI	P30T-1	P-445	P-141	-	P-143	-	-	P-435	P-513
TOSHIBA MACHINE	-		-		P50T-1	P-299	-	-	-
NIIGATA MACHINE TECHNO	-		-		P50T-2	P-419	-	-	-
FANUC	P30T-1	P-522	-		-		P-522	-	-
BROTHER	P30T-2	P-511	-		-		P-511	-	-
HOWA	P30T-1	P-445	P40T-1	P-297	P50T-1	P-299	-	-	-
MAKINO	-		P40T-1	P-297 (V-series)	P50T-1	P-299 (A, MCC, V-series)	-	P-323-1	P-299
			P-348	P-323-1 (a-series, D-series)	P-400 (A-series, a-series)				
MATSUURA	P30T-2	P-511	P-348	P-323-1	P50T-2	P-419	-	P-323-1	-
	P-399				P-400				
MITSUI SEIKI	-		P-007	-	P-008	P-250	-	-	-
MITSUBISHI	-		P40T-1	-	P50T-2	-	-	-	-
YASDA	-		P-348	P-438	P50T-1	P-299	-	P-509	P-459
					P-400 (YBM1218V)			-	P-288-1 (YBM1218V)
YAMAZAKI GIKEN	-		P40T-1	P-297	P50T-2	P-419	-	-	-
MAZAK	-		P-227		P-514		-	P-227	P-514

BT30

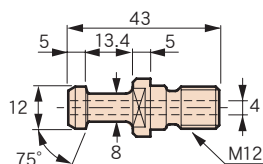
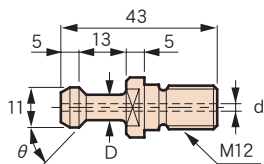

CODE	φD	φd	θ	Note
P30T-1	7	-	45	MAS-1
P-445		3		P30T-1 through hole
P30T-2		-	60	MAS-2
P-497		2		P30T-2 through hole
-522	8	4	45	FANUC center-through
-511	7.5	2.5	60	BROTHER center-through

CODE	Note
P-399	JIS30P

BT40

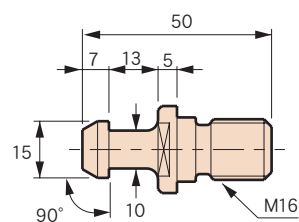
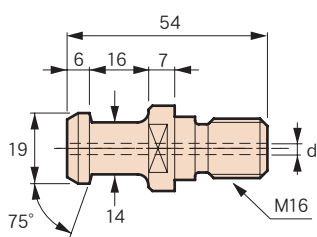
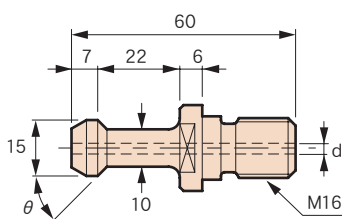

CODE	φd	θ	Note
P40T-1	-	45	MAS-1
P-297	4		P40T-1 through hole
P40T-2	-	60	MAS-2
P-339	4		P40T-2 through hole
-141	-	90	-
-498	4		P-141 through hole
-505	3	45	KOMATSU NTCcenter-through

CODE	φd	Note
P-348	-	JIS40P
-323-1	7	P-348 through hole
-499	4	OKUMA center-through
-438	7	YASDA through hole
-509		YASDA center-through

CODE	Note
P-007	MITSUI SEIKI

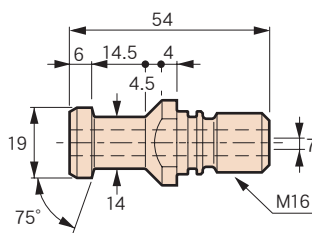
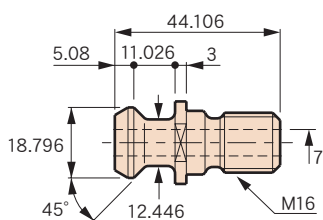

CODE	Note
P-227	MAZAK

CODE	Note
P-435	DMG MORI center-through

HSK-T Tooling Systems for Turning Mill

**World
standard
ISO**
for Turning Mill
HSK
TOOLING SYSTEM

Set screw holders for Round shank

For through-spindle coolant
CC type



For nozzle-coolant
CN type



➔ P.69

Insert holders for Square-shank

For external turning and cutting off
SV type



For external / face turning
SA type



For external / face turning
SB type

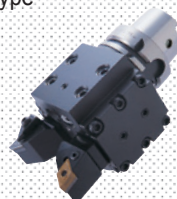

For external / face turning
SC type



For external / face turning
SN type



For face turning
SH type



➔ P.70

BLANK TOOL

CHECKING ARBOR



➔ P.72



➔ P.72



HSK-T TOOLING SYSTEMS for TURNING MILL

The obvious choice for ISO standard, HSK-T specs turning mill spindles!!

- ▷ A full range of milling tool holders, covering 70% of multi-tasking machine applications!
- ▷ Compatible with machining center holders!
- ▷ Supplied by tool holder manufacturer world wide!
- ▷ Extensive line-up and reasonable price!

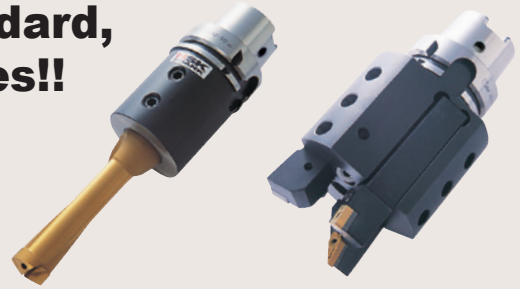

Standardized by many machine tool manufacturers!

OKUMA · MULTUS SERIES · MACTURN SERIES etc	DMG MORI · NT (NTX) Series · FD Series · CTX Series	Nakamura-tome Precision Industry · Super NTJX Series · Super NTMX Series etc	YAMAZAKI MAZAK · INTEGREX i Series J Series e Series etc
MATSUURA MACHINERY CORPORATION · CUBLEX Series	HERMLE · MT Series	HORKOS · NS70 Version	

Turning tools (HSK-T standard)

Maintains high precision during turning operation

By using an ICTM tool holder, which minimizes the gap between the machine spindle drive key and tool holder drive key way, the height of the cutting edge is maintained precisely and variation in workpiece diameter is minimized.

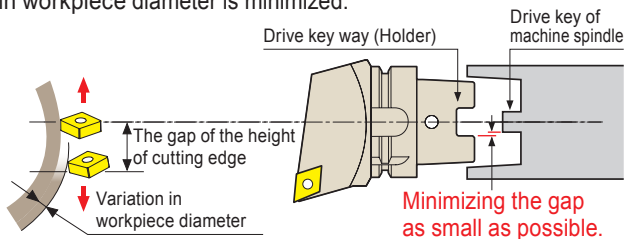

High bending rigidity

During turning, the cutting force of a spindle axis becomes very large. Therefore, a rigid, two-face-contact clamping system performs very well.

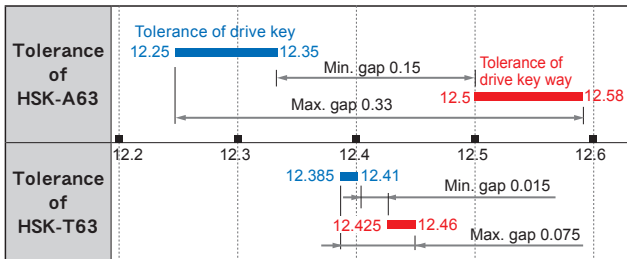
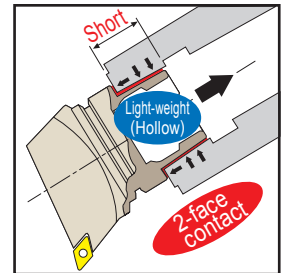

Designed to shorten undercut area

We made an undercut area thicker and as short as possible in order to increase the holder rigidity.

Improved rigidity!

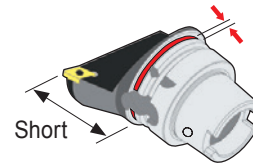

Undercut area
 Width 4 mm
 Depth 0.5 mm

Rotating tools (HSK-A standard)

Compatible with machining center

Needless to say, the holder of a machining center and a turning mill machine can be shared.

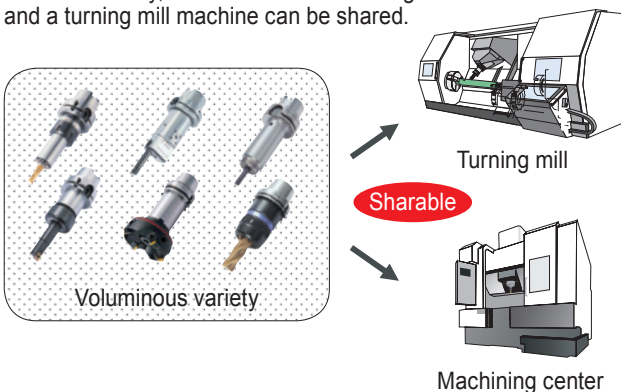

Pre-balanced design

The HSK-A-type shank is unbalanced in its standard form, but at MST we have applied our original pre-balancing to make the tool holders applicable for high-speed machining. According to DIN standards, only the area marked with ※ in the hollow shank needs to be finished. However, MST provides perfect finishing for all areas after heat treatment in order to improve balance.

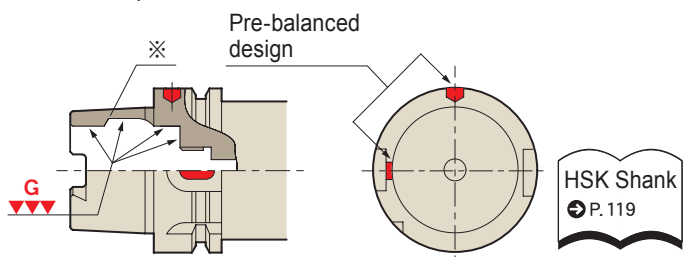

Set screw holders for Round shank

CC type for through-spindle coolant

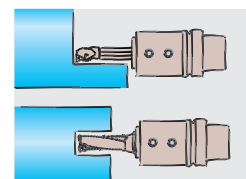
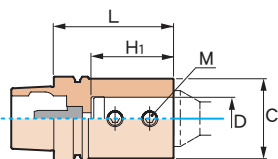

CODE	L	φD	φC	H ₁	M	Kg
T40 -CC32- 90	90	32	58	62	M12	1.2
T50 -CC32- 85	85	32	62	62	M12	1.4
T63 -CC32- 90	90	32	62	62	M12	1.6
-CC40-100	100	40	68	72		2
T100 -CC40-105	105	40	82	72	M12	4.5
-CC50-115	115	50	92	82	M14	5.3

- **Option**
 - Sleeve for set screw holder (SS)
- **Std. Access.**
 - Coolant duct→P.104
- **Note**
 - Available for both boring bar and indexable drill.

CN type for nozzle-coolant

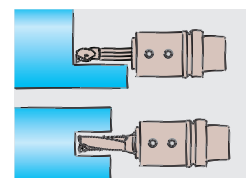
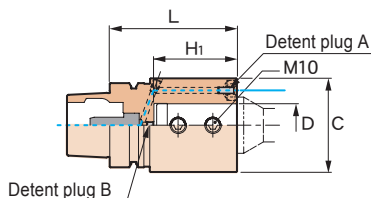

CODE	L	φD	φC	H ₁	M	Kg
T40 -CN32- 95	95	32	70	62	M12	2
T50 -CN32-100	100	32	70	62	M12	2.1
T63 -CN32- 95	95	32	70	62	M12	2.2
-CN40-105	105	40	78	71		2.7
T100 -CN40-115	115	40	82	72	M12	4.9
-CN50-125	125	50	92	82	M14	5.8

- **Option**
 - Sleeve for set screw holder (SS)
- **Std. Access.**
 - Coolant duct→P.104
 - Detent plug for a nozzle A = Set screw (M5-12L)
 - Detent plug for Center through B = Set screw (M5-5L)
- **Note**
 - The coolant nozzle direction is adjustable.
 - Nozzle-coolant type is available for through-spindle coolant.
 - Available for both boring bar and indexable drill.

Sleeve for set screw holders

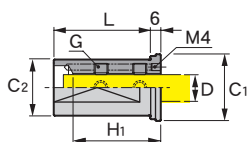

CODE	L	φD	φC ₁	φC ₂	H ₁	G
SS32- 8	55	8	38	32	35	M 6
-10					40	M 8
-12					45	
-16					50	
-20						
-25					58	※
SS40- 8	60	8	46	40	35	M 6
-10					40	M 8
-12					45	
-16					50	
-20						M10
-25					58	
-32					62	※

- **Note**
 - Items marked with ※ in the G section of the list means they are screw-tightening type.
 - Available for both boring bar and indexable drill.

Insert holders for Square-shank

SV type for external turning and cutting off

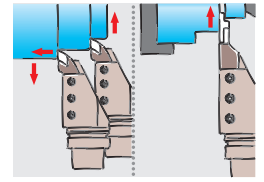
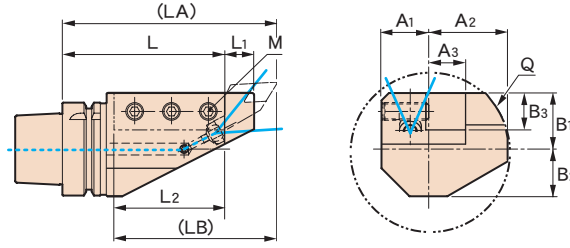

CODE	L	L ₁	L ₂	(LA)	(LB)	A ₁	A ₂	A ₃	B ₁	B ₂	B ₃	M	Q	kg
T40 -SV2020R- 90	90	15	60	120	90	24.5	39	20	25	22	20	M10	78	1.5
-SV2020L- 90														
T50 -SV2020R- 95	95	15	60	125	90	25	43.5	20	25	25	20	M10	87	1.9
-SV2020L- 95														
T63 -SV2020R-105	105	20	70	135	100	32	45	20	33	32	20	M12	90	2.7
-SV2020L-105														
-SV2525R-105※								105	135	45	28		90	2.7
-SV2525L-105※														
-SV2525R-105D	115	145	53.5	38	108	3.3								
-SV2525L-105D														
-SV2525R-115	115	145	53.5	38	108	3.3								
-SV2525L-115														
T100 -SV2525R-150	150	20	70	190	150	37	59	25	48	43	25	M12	118	9.1
-SV2525L-150														
-SV3232R-150		25	100	195	145	40	68.5	32	47	32	M14	137	9.3	
-SV3232L-150														

- Std. Access.
 ● Coolant duct→P.104

- Note
 ● The coolant nozzle direction is adjustable.

- Caution
 ● The maximum coolant pressure for the nozzle on the holder is 1.5MPa.
 ● The holder marked with ※ in the chart cannot be installed on the Mazak INTEGREX I and J series.

SA type for external / face turning

The multi-inserts type holder reduces using holders quantity, it saves A.T.C. magazine pot.

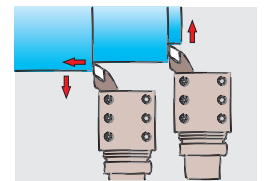
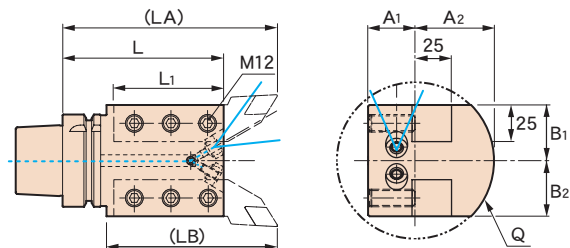
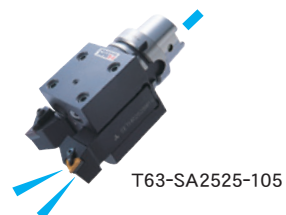

CODE	L	L ₁	(LA)	(LB)	A ₁	A ₂	B ₁	B ₂	Q	kg
T63 -SA2525-105※	105	70	135	100	32	54	38	38	108	3.7
-115										
T100 -SA2525-150	150	70	185	105	37	59	48	48	118	9.3

- Std. Access.
 ● Coolant duct→P.104
 ● Detent plug for a nozzle=Set screw(M5-12L)(Ex.) When using only right-hand, plug the nozzle on the left-hand side.

- Note
 ● The coolant nozzle direction is adjustable.

- Caution
 ● The maximum coolant pressure for the nozzle on the holder is 1.5MPa.
 ● The holder marked with ※ in the chart cannot be installed on the Mazak INTEGREX I and J series.

SB type for external / face turning

The multi-inserts type holder reduces using holders quantity, it saves A.T.C. magazine pot.

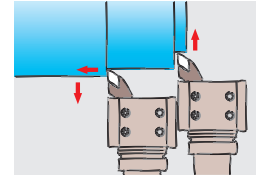
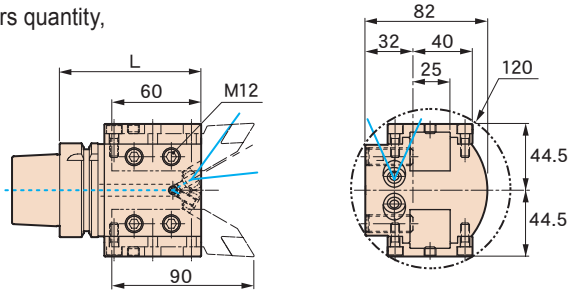

CODE	L	Kg
T63-SB2525- 95 *	95	3.2
-105	105	

■ Std. Access.

- Coolant duct → P.104
- Detent plug for a nozzle = Set screw (M5-12L)
(Ex.) When using only right-hand, plug the nozzle on the left-hand side.

■ Note

- The coolant nozzle direction is adjustable.

■ Caution

- The maximum coolant pressure for the nozzle on the holder is 1.5MPa.
- The holder marked with * in the chart cannot be installed on the Mazak INTEGREX I and J series.

SC type for external / face turning

The multi-inserts type holder reduces using holders quantity, it saves A.T.C. magazine pot.

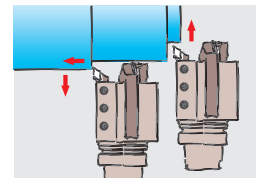
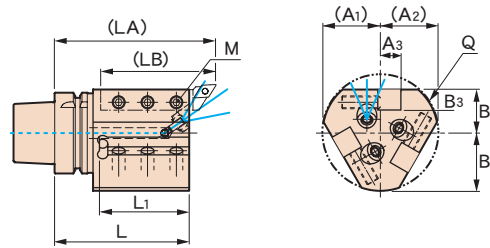

CODE	L	L ₁	(LA)	(LB)	(A ₁)	(A ₂)	A ₃	B ₁	B ₂	B ₃	M	Q	Kg
T40 -SC1616R- 90	90	60	110	80	38	38	16	30	38.5	16	M10	77	1.7
T50 -SC2020R- 95	95	60	125	90	44.5	44.5	20	35	45	20	M10	90	2.4
T63 -SC2020R-105	105	70	140	105	44.5	44.5	20	35	45	20	M12	90	3.0
T100-SC2525R-150	150	70	185	105	59	59	25	48	59	25	M12	108	9.7

■ Std. Access.

- Coolant duct → P.104
- Detent plug for a nozzle = Set screw (M5-12L)

■ Note

- The coolant nozzle direction is adjustable.

■ Caution

- The maximum coolant pressure for the nozzle on the holder is 1.5MPa.

SN type for external / face turning

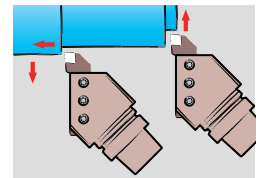
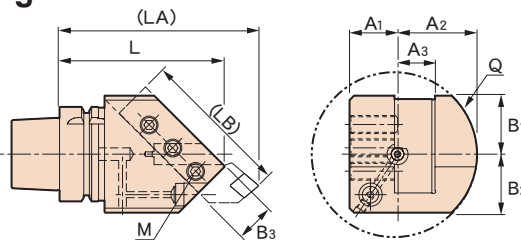

CODE	L	(LA)	(LB)	A ₁	A ₂	A ₃	B ₁	B ₂	B ₃	M	Q	Kg
T40 -SN2020R-100	100	125	80	25	40	20	32	32	20	M10	80	1.7
T50 -SN2020R-110	110	135	85	25	45	20	35	35	20	M10	90	2.2
T63 -SN2020R-110	110	135	85	25	45	20	35	35	20	M10	90	2.5
-SN2020L-110												
-SN2525R-110												
-SN2525L-110												
T100-SN2525R-135	135	165	105	32	54	25	43	43	25	M12	108	6.1
-SN2525L-135												
-SN3232R-135												
-SN3232L-135												

■ Std. Access.

- Coolant duct → P.104

■ Note

- The coolant nozzle direction is adjustable.

■ Caution

- The maximum coolant pressure for the nozzle on the holder is 1.5MPa.

SH type for face turning

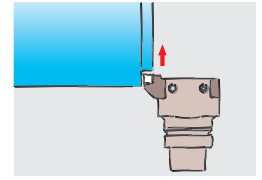
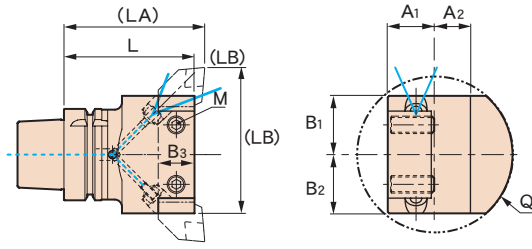
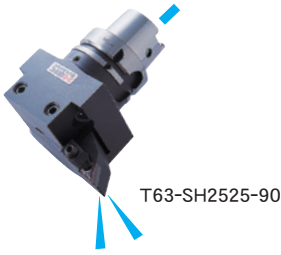

CODE	L	(LA)	(LB)	A ₁	A ₂	B ₁	B ₂	B ₃	M	Q	Kg
T40 -SH2020- 75	75	79	70	25	20	25	25	20	M12	80	1.2
-120	120	124									1.6
T50 -SH2020- 90	90	94	75	25	20	27.5	27.5	20	M12	90	1.8
-120	120	124									2.3
T63 -SH2020- 90	90	94	80	32	20	30	30	20	M12	90	2.5
-SH2525- 90		97									100
-120		120	127								3.6
T100 -SH2525-105	105	112	120	32	25	48	48	25	M12	118	6.1
-150	150	157									8.8
-SH3232-105	105	113	145	40	32	57	57	32	M14	148	7.7

- **Std. Access.**
 • Coolant duct → P.104 • Detent plug for a nozzle = Set screw (M5-12L)
 (Ex.) When using only right-hand, plug the nozzle on the left-hand side.
- **Note**
 • The coolant nozzle direction is adjustable.

- **Caution**
 • The maximum coolant pressure for the nozzle on the holder is 1.5MPa.

BLANK TOOL (For additional machining)

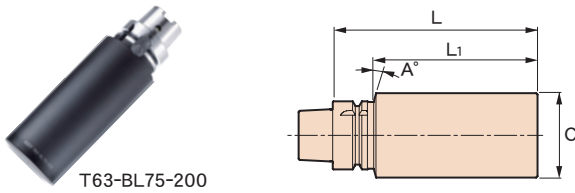

CHECKING ARBOR

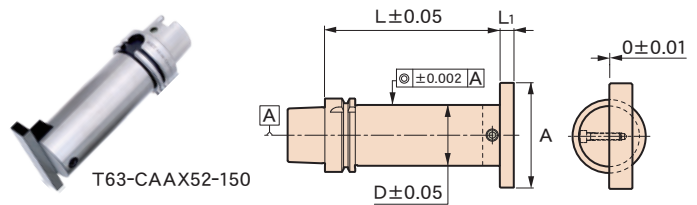

CODE	L	L ₁	φC	A°	Kg
T40 -BL 32- 35	35	15	32	0	0.3
-BL 48-120	120	97	48	15	1.6
-BL 95- 75	75	52	95		2.9
T50 -BL 40- 42	42	16	40	0	0.6
-BL 62-150	150	120	62	15	3.3
-BL105- 90	90	60	105		4.3
T63 -BL 52- 45	45	19	52	0	1.0
-BL 75-200	200	168	75	15	6.6
-BL115- 90	90	58	115		5.5
T100 -BL 87- 45	45	16	87	0	2.8
-BL100-200	200	166	100		12.6
-BL118-120	120	86	118	15	9.7

CODE	L	L ₁	φD	A	Kg
T40 -CAAX32-150	150	10	32	60	1.1
T50 -CAAX40-150	150	10	40	70	1.7
T63 -CAAX52-150	150	10	52	90	2.9
T100 -CAAX60-250	250	12	60	110	7.2

- **Std. Access.**
 • Coolant duct → P.104
 • Special case
- **Usage**
 1. Measure the concentricity of the spindle using cylinder area.
 2. When using a flat surface, adjustment of the insert position can be verified.
 3. Confirm and adjust the absolute dimension in the X direction.
 4. Measure the bending of the spindle using flange surface area.
 5. Can be used with tool presetter.
- **Note**
 • ATC repeatability can be observed.
 • Flatness of square test bar for the datum A is within ±0.01mm.

- **Std. Access.**
 • Coolant duct → P.104
- **Note**
 • Material: SNCM439, Heat treatment hardness : 43HRC±2
 • Hardening depth indicates depth to the center.
- **Caution**
 • If heat treatment is applied again to a holder produced from a blank tool, the original taper area may be deformed. Therefore, please do not apply heat treatment.

Universal Facing Boring Head

Universal Boring Head allows any applications just using this holder.

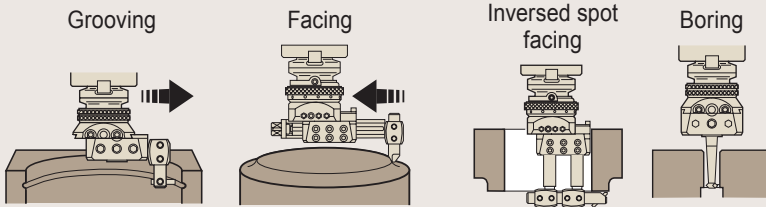

Automatic feeding using the machine spindle rotation.

High accuracy and Long life

Hand scraping surface leads to higher accuracy and longer life.



Specification

We guarantee a slide traverse accuracy of 5μm squareness at 50L, and we provide thorough overhaul and repair after-service.

TYPE	Max. Boring diameter	Max. slide movement	Automatic feed speed	Fine adjustment (one graduation)	Fast return screw	Max. rotation min ⁻¹	Kg
MU	φ260	48	0.05 / Rotation	0.005 Vernier scale 0.001	—	600	2.1
MU-S4	φ400	52	0.02 } 0.24 / Rotation 12 speeds	0.005	3.0 / Rotation	400	7
MU-S5	φ620	112					8.7
MU-S6H	φ800	140				250	21
MU-S6	φ920	210					23.3

Parts name

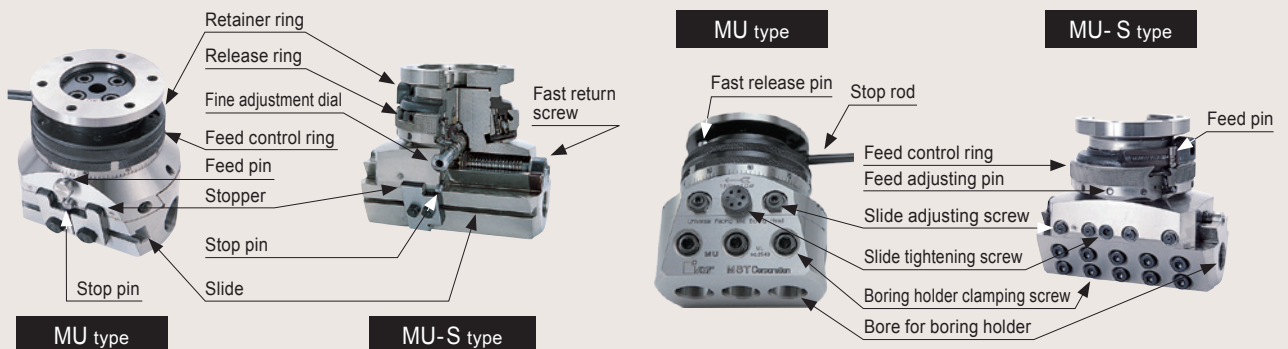

Combination of shank and head

Shank

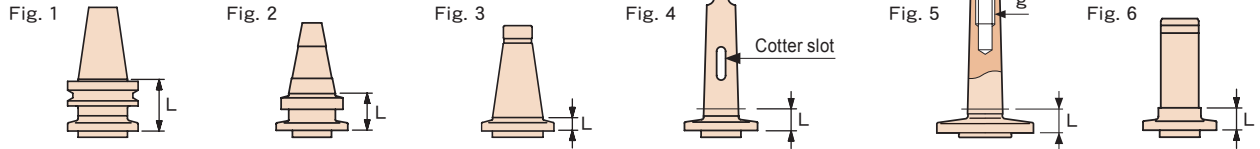

※Please inform us when the cotter slot is needed.
(please inform us the machine brand and model).

CODE	Fig.	L	g
BT40 -MU	1	49	—
H 40 -MU	2	34	—
NT40U-MU	3	15	—
MT3 -MU(Tang type)	4	18	—
MT4 -MU(Tang type)		19.5	—
MT3 -MU(Screw type)	5	18	M12
MT4 -MU(Screw type)		19.5	M16
S32 -MU-20	6	20	—
S42 -MU-20			—

CODE	Fig.	L	g
BT50 -MU-S4/S5	1	73.5	—
H 50 -MU-S4/S5	2	44.5	—
NT40U-MU-S4/S5	3	17.1	—
NT50U-MU-S4/S5		18.7	—
MT4 -MU-S4/S5(Tang type)	4	28	—
MT5 -MU-S4/S5(Tang type)			—
MT6 -MU-S4/S5(Tang type)		29.5	—
MT4 -MU-S4/S5(Screw type)	5	27	M16

CODE	Fig.	L
BT50 -MU-S6H/S6	1	77
NT50U-MU-S6H/S6	2	28.2
MT6 -MU-S6H/S6(Tang type)	3	35

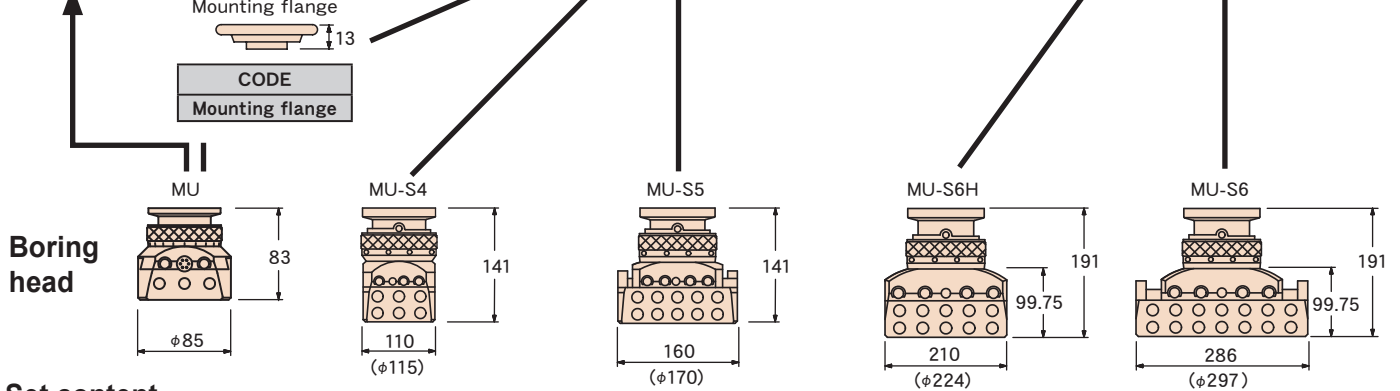

Set content

Boring head (set)		MU	MU-S4	MU-S5	MU-S6H	MU-S6				
Accessories										
Boring head		MU-H	MU-S4-H	MU-S5-H	MU-S6H-H	MU-S6-H				
Boring bar	Diameter×length	18× 60	22× 85	22× 85	30×120	30×120				
	Effective length	30	45	45	70	70				
	Q'ty	1	1	1	1	1				
		18× 90	22×125	22×125	30×200	30×200				
	60	85	85	150	150					
	1	1	1	1	1					
	18×120	22×165	22×165	30×260	30×260					
	90	125	125	210	210					
	1	1	1	1	1					
Boring bar holder	Diameter×Shank length	18× 82	22× 98	22× 98	30×120	30×120				
	Q'ty	1	3	2	2	2				
		18×120	22×180	22×130	30×220	30×220				
	Q'ty	1	1	1	1	1				
	—	—	22×229	30×360	30×360					
	—	—	1	1	1					
Adjustment collar for boring bar holder	—		Inner diameter×Thickness	Q'ty	Inner diameter×Thickness	Q'ty	Inner diameter×Thickness	Q'ty		
	—		22×10	1	22×10	1	30×10	1		
	—		22×20	1	22×20	1	30×20	1		
	—		22×60	1	22×45	1	30×40	1		
	—		—	—	22×60	1	30×70	1		
	—		—	—	—	—	30×80	1		
Draw bolt for boring bar holder	—		Diameter×length	Q'ty	Diameter×length	Q'ty	Diameter×length	Q'ty		
	—		M12×40	1	M12×89	1	M16×80	1		
	—		—	—	—	—	—	—		
	—		—	—	—	—	—	—		
Clamping sleeve	Outer dia.× Inner dia.	Q'ty	Outer dia.× Inner dia.	Q'ty	Outer dia.× Inner dia.	Q'ty	Outer dia.× Inner dia.	Q'ty		
	18× 8	1	22× 8	1	22× 8	1	22×12	1		
	18×10	1	22×10	1	22×10	1	22×14	1		
	18×12	1	22×12	1	22×12	1	22×18	1		
	18×14	1	22×14	1	22×14	1	30×22-A	1		
	—	—	22×18	1	22×18	1	30×22-B	1		
Insert	Material	□ × length	Q'ty	□ × length	Q'ty	□ × length	Q'ty	□ × length	Q'ty	
	HSS	□ 6×30L-H	3	□ 6×40L-H	3	□ 6×40L-H	3	□ 10×60L-H	3	
	Carbide	□ 6×30L-C	1	□ 6×30L-C	1	□ 6×30L-C	1	□ 10×60L-C	1	
Other accessories	<ul style="list-style-type: none"> ●Stop rod ●Spanner ●Knocking rod ●L wrench 		<ul style="list-style-type: none"> ●Stop rod ●T handle wrench ●Connection for wrench ●L wrench ●Spanner 		<ul style="list-style-type: none"> ●Stop rod ●T handle wrench ●Connection for wrench ●L wrench ●Spanner 		<ul style="list-style-type: none"> ●Stop rod ●T handle wrench ●Connection for wrench ●Auxiliary bar ●L wrench ●Spanner 		<ul style="list-style-type: none"> ●Stop rod ●T handle wrench ●Connection for wrench ●Auxiliary bar ●L wrench ●Spanner 	

■ Note
●We can provide only the head without accessories.

The fixture creates the new machining process.

- ▷ A highly rigid work-clamping fixture developed for both 5-axis machining centers and multi-surface machining with 3-axis machining centers (with a rotary table)

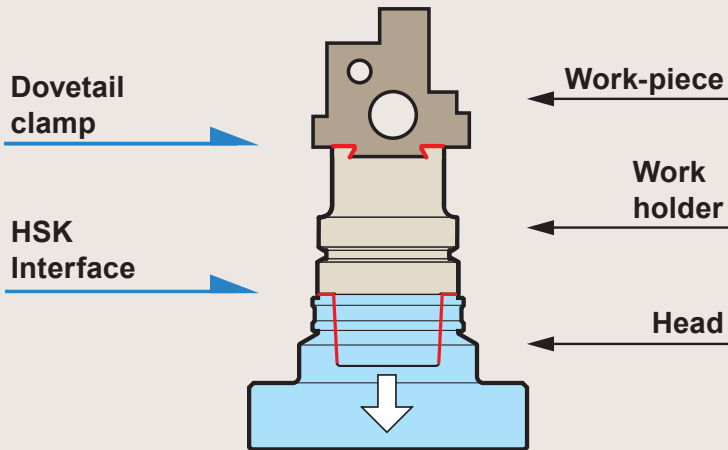

5-axis machine
Clamping force



Automated robotic work-piece changing system
3-axis + rotary table



Small- and Medium-size Enterprises Award for Excellence in New Innovative Technologies and Products
The Resona Foundation for Small and Medium Enterprise Promotion and The Daily Industrial News

Multi-surface machining

Process integration on a 3-axis machining center with a rotary table and 5-axis machining center

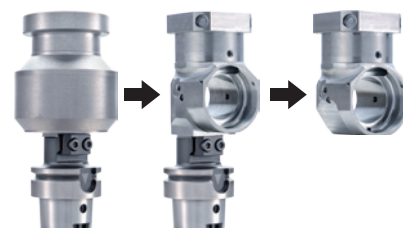
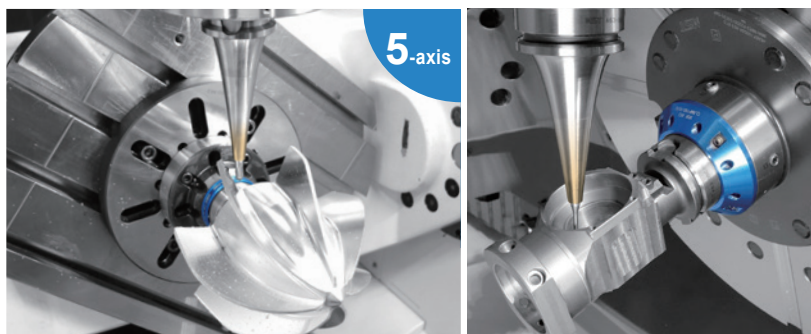
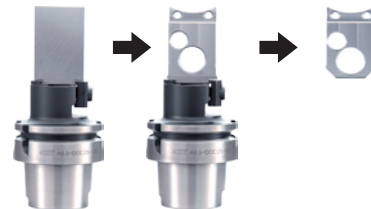
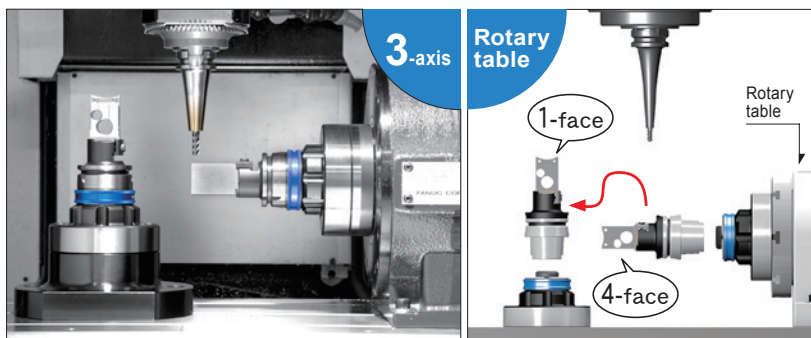

Clamping force

HSK (2-face clamping interface) and dovetail clamping

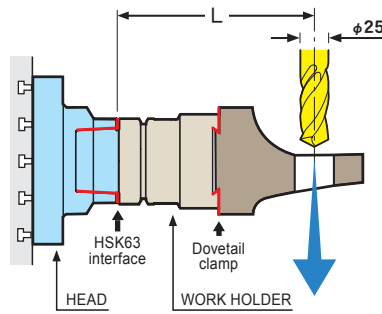
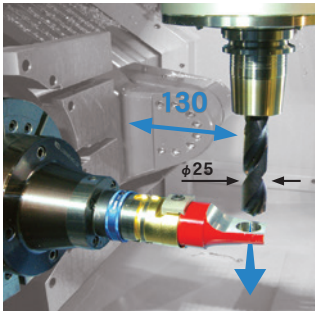

Maximum cutting force

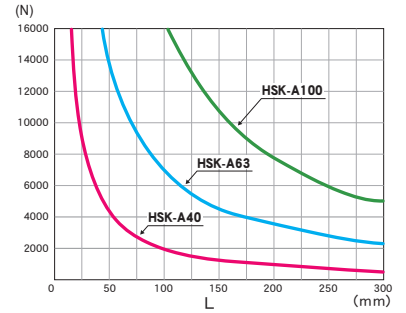

Avoids interference

The fixture(work-holders and heads) design has much smaller than the work-piece.

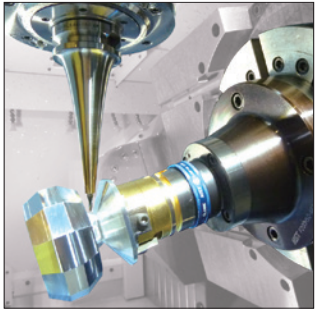

- The fixture has less interference with a tool holder and a cutting tool and it endures large machining force in a different direction.

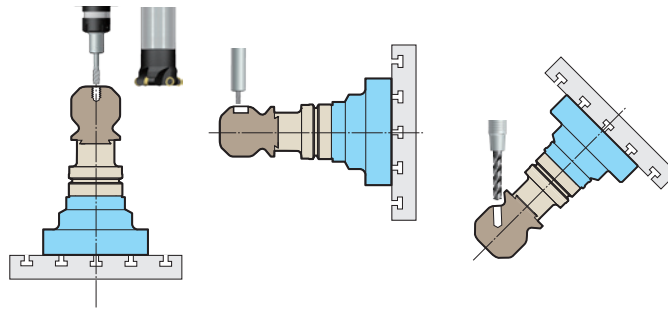

Quick change

Clamping 5-sec. Unclamping 5-sec.



- Easy operation – just mount the work holder on the head and tighten with a wrench.

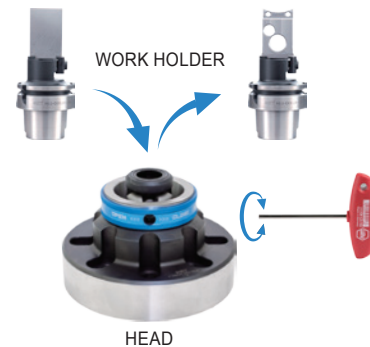

Off-line set-up

Minimizing machine downtime.

- You can start machining the next work-piece quickly when it is mounted in a work holder in advance.
- The machine runs continuously, so you can maximize the machine utilization ratio.

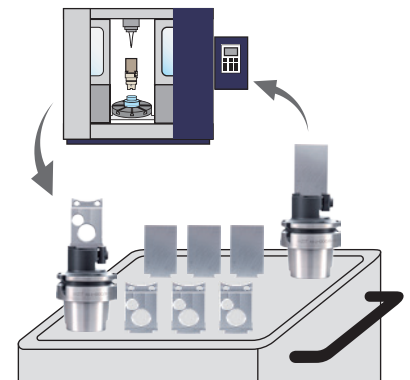
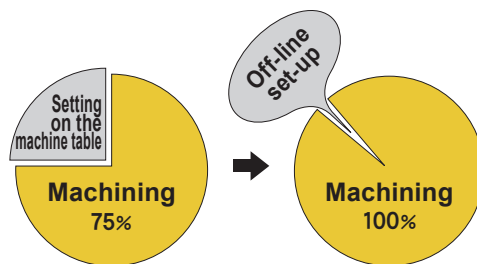

Repeatability

No alignment by experienced workers required.

L=3×D	D	L
A40	40	120
A63	63	190
A100	100	300

If necessary, please off-set the rotational direction using a touch probe.

BLUM high-accuracy touch probe

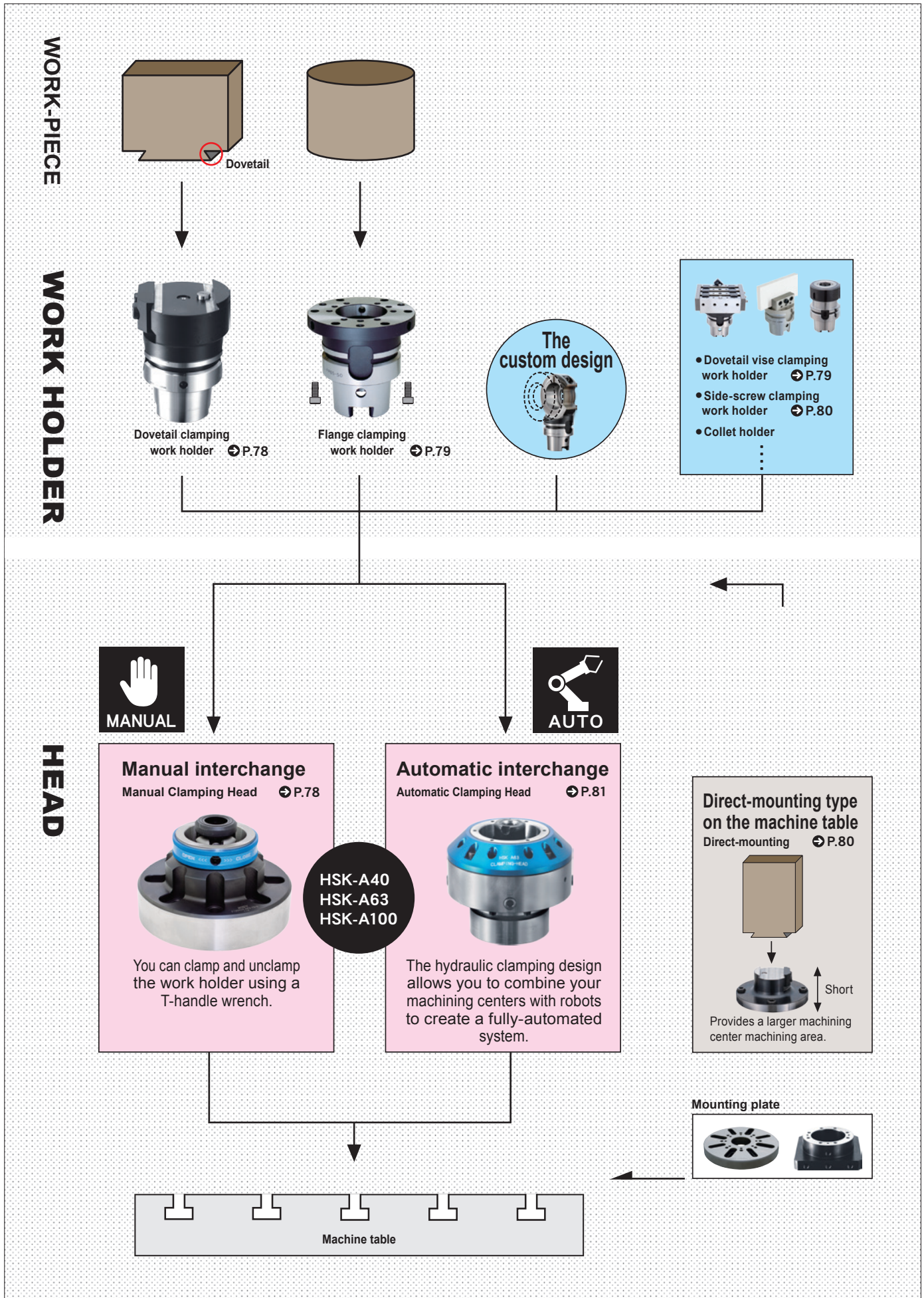

HEAD

The Manual Clamping Head (Manual exchange)

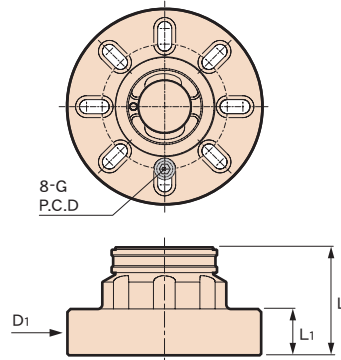
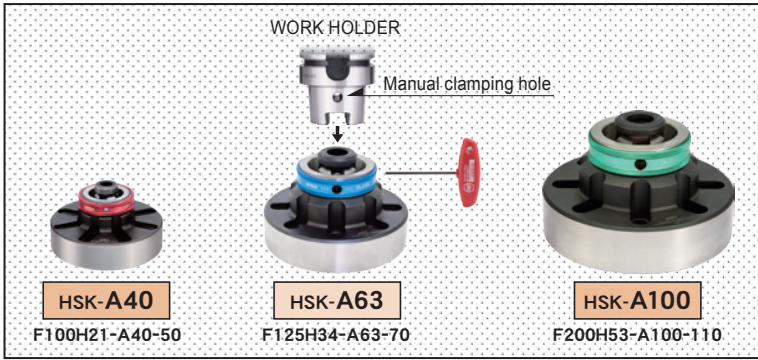

CODE	Interface	L	φD1	L1	G	P.C.D.	Clamping force (kN)	Kg
F 100H21-A40 - 50	HSK-A40	50	100	25	M 6×30	55~ 85	10	1.7
F 125H34-A63 - 70	HSK-A63	70	125	30	M 8×35	80~100	20	3.8
F 200H53-A100-110	HSK-A100	110	200	50	M12×50	125~160	30	14

- Option
 - Mounting plate
- Std access.
 - T-handle wrench • Mounting bolt × 4pcs.
- Note
 - A manual clamping hole on the work holder is required for mounting.

Please use a mounting plate if the fixing hole of the head doesn't match with a T-groove on the machine table. Also, we can make a custom-designed mounting plate for you if necessary.

CODE	Interface	T	φD	φH	G1	G2	G3	P.C.D.	Kg
F160H32-A40	HSK-A40	20	160	32	M 5×20	M 6×20	M 6	80~125	2.6
F200H32-A40		25	200		M 8×25	M10×25		100~160	5
F160H50-A63	HSK-A63	20	160	50	M 5×20	M 6×20	M 6	80~125	2.4
F200H50-A63		25	200		M 8×25	M10×25		100~160	4.7
F250H50-A63		30	250	50	M10×30	M12×30	M12	140~200	9.4
F250H80-A100	HSK-A100	30	250	80	M10×30	M12×30	M12	140~200	8.7

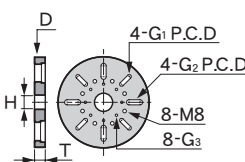

WORK HOLDER

Dovetail clamping work holder

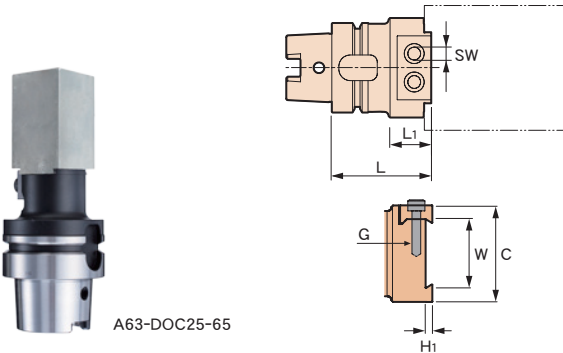

CODE	L	L1	φC	W	H1	G	SW	Kg
A40 -DOC 17.5-55	55	25	30	17.5	2	M 5	4	0.4
		28	40	25	3	M 6	5	0.6
		25	50	35				0.7
A63 -DOC 25 -65	65	30	70	50	5	M 8	6	1.2
		27	40	25	3	M 6	5	1.2
		50	35					1.3
A100-DOC 35 -70	70	30	70	50	5	M 8	6	1.8
		35	100	70		M10	8	3
		27	50	35	3	M 6	5	3.3
A100-DOC 50 -75	75	32	70	50	5	M 8	6	3.8
		35	100	70		M10	8	5
		40	140	100	10			7.7

Dovetail grooving a work-piece
 Dovetail grooving of the work-piece clamping area using an angular cutter is required prior to machining. After machining, cut off the dovetail of the work-piece.



Details of dovetail dimensions

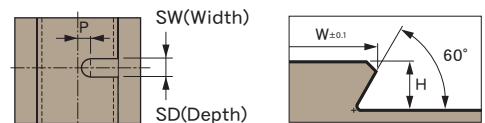

Holder type	W	H	P	SW	SD
DOC 17.5	17.5	2.5	2.5	4	2
DOC 25	25	3.5		6	2.5
DOC 35	35		5.5	8	
DOC 50	50	5.5	9	10	4
DOC 70	70		18	12	
DOC100	100	10.5	26	15	

Flange clamping work holder



A63-FP85-50

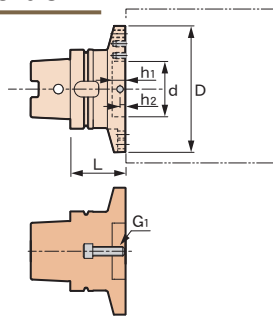

Fig. 1

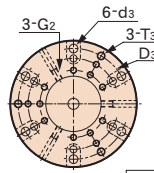

Fig. 2

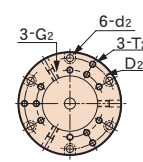
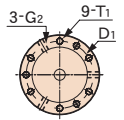
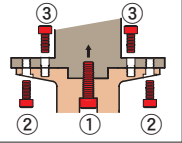

Fig. 3



3 Ways to Mount Work-pieces

- ① Center bolt
- ② Flange bolt from the head
- ③ Flange bolt from the work-piece



CODE	Fig.	L	φD	φD1	φD2	φD3	φd	h1	h2	T1	T2	T3	φd2	φd3	G1	G2	KG
A40 -FP 40-35	3	35	40	32	—	—	25	12	4	M4×6	—	—	—	—	M 6×15	M4×8	0.3
-FP 63-40	2	40	63	—	50	—	$25^{+0.053}_{+0.020}$	—	—	—	M5	—	5.5	—	M 6×20	—	0.5
A63 -FP 63-45	3	45	63	50	—	—	40	13	5	M5×8	—	—	—	—	M10×20	M6×10	0.9
-FP 85-50	2	50	85	—	73	—	$40^{+0.064}_{+0.025}$	—	—	—	M6	—	6.6	—	M10×25	—	1.2
-FP110-55	1	55	110	—	95	—	—	—	—	—	M6×9	M 8	9	—	M10×30	—	1.7
A100 -FP100-55	3	55	100	85	—	—	70	17	7	M8×12	—	—	—	—	M12×25	M8×16	3.0
-FP130-65	2	65	130	—	115	—	$70^{+0.076}_{+0.030}$	—	—	—	M8	—	9	—	M12×35	—	4.2
-FP160-70	1	70	160	—	140	—	—	—	—	—	M8×12	M10	11	—	M12×40	—	5.3

Std access.

- Center bolt (G1)×1pc.
- Set screw (G2)×3pcs.
- M6 special small-head bolt (the head diameter size is the same as the M5 bolt)×3pcs. (A63FP-85-50 / A63-FP110-55)
- ※Regular M6 cap screw doesn't fit.

Option

- Positioner boss
- Adapter

Note

- Use the G1 set screw when you use the center bolt to clamp the work-piece. When you need whirl-stop machining of a work-piece, make a flat surface on the work-piece and clamp it using a set screw (G2).

Positioner boss (Flange clamping)

Use it when you need centering.

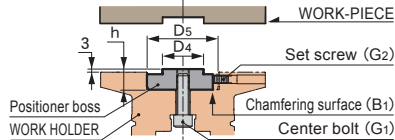

CODE	Holder type	φD4	φD5	h	KG
IR15-A40 FP	HSK-A40	$15^{0}_{-0.027}$	25	15	0.05
IR25-A63 FP	HSK-A63	$25^{0}_{-0.033}$	40	16	0.1
IR40-A100FP	HSK-A100	$40^{0}_{-0.039}$	70	20	0.5

Note

- When you do not want the work-piece to rotate, make a flat surface on the O.D. (B1) of the boss, and attach it using a set screw (G2).



Please use an adapter for small size work-pieces.

Minimizing clamping area for a small-size work-pieces reduces the interference area.



RS-A63-A40

CODE	Work holder	Fig.	φD	φD1	φd	H1	H2	H	T1	G1	G2	G3	KG
RS-A63 -A40	A63 -FP 63-45	1	40	32	25	12	4	50	M4×6	M 6×20	M4×8	M5×16	0.5
	-FP 85-50	—	$40^{+0.064}_{+0.025}$	—	—	—	—	—	—	—	—	—	—
	-FP110-55	—	—	—	—	—	—	—	—	—	—	—	—
RS-A100-A40	A100-FP100-55	2	40	32	25	12	4	60	M4×6	M 6×20	M4×8	M8×25	1.5
	-FP130-65	—	$40^{+0.053}_{+0.020}$	—	—	—	—	—	—	—	—	—	—
	-FP160-70	—	—	—	—	—	—	—	—	—	—	—	—
RS-A100-A63	A100-FP100-55	1	63	50	40	13	5	55	M5×8	M10×20	M6×10	M8×25	1.7
	-FP130-65	—	$63^{+0.053}_{+0.020}$	—	—	—	—	—	—	—	—	—	—
	-FP160-70	—	—	—	—	—	—	—	—	—	—	—	—

Std access.

- Center bolt (G1)×1pc.
- Set screw (G2)×3pcs.
- Fixing bolt (G3)×3pcs.

Note

- Attach the work-piece with the center bolt (G1). When you do not want the work-piece to rotate, secure the chamfering surface using a set screw.

Fig. 1

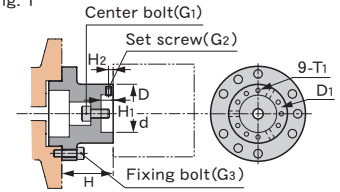
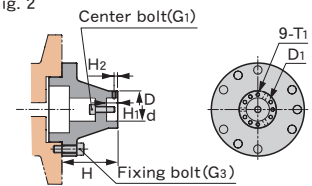

Fig. 2



Dovetail Vise clamping work holder



A63-DOV90

Fig. 1

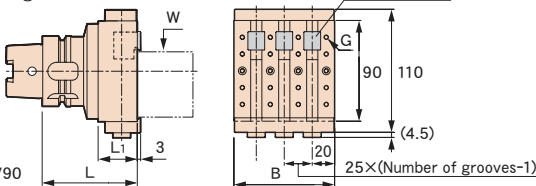

A63-DOV110I

Fig. 2

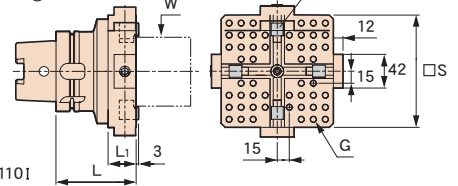

CODE	Fig.	□S	Number of grooves	B	W	G (Depth)	L	L1	KG
A63 -DOV 90	1	—	3	90	12~73	20-M4(6)	85	35	3.8
110I	2	110	—	—	36~80	24-M8(10)	90	—	5.7
A100 -DOV140	1	—	5	140	12~73	30-M4(6)	100	35	7.7
	140I	2	140	—	—	52-M8(10)	—	—	9.9

Std access.

- 8mm hexagonal wrench



Angular cutter

For more information, please contact MST.

Note

- Dovetail grooving of the work-piece clamping area using an angular cutter is required prior to machining. After machining, cut off the dovetail of the work-piece.
- Work-piece clamping jaws move individually.
- Please use the screw hole on the top face as necessary.

Side screw clamping work holder

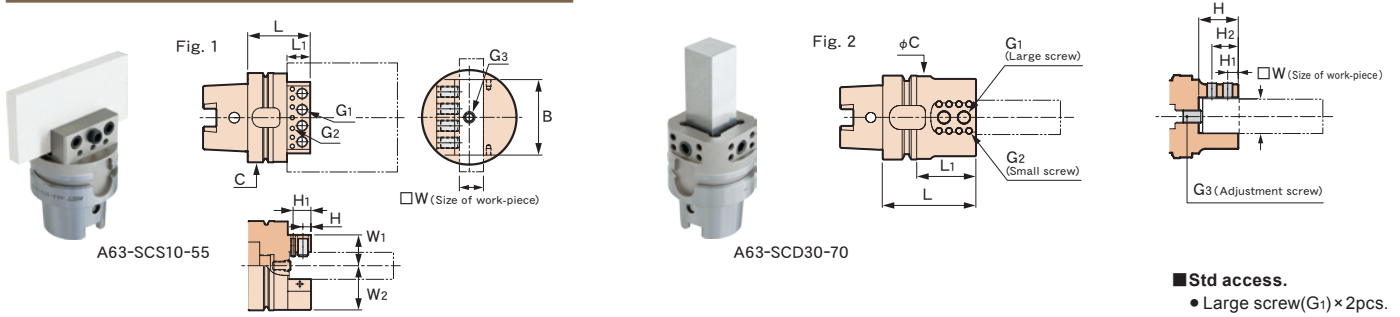

■ Std access.
 • Large screw(G1) × 2pcs.

CODE	Fig.	□W	W ₁	W ₂	B	L	L ₁	ϕC	H	H ₁	H ₂	G ₁ (Bolt)	G ₂	G ₃	KG
A40 -SCS10-40	1	5 ~ 10	13	18.6	30	40	11	39	4.5	—	—	M 6×10	—	M 6	0.5
-SCD20-55	2	15 ~ 20	—	—	—	55	30	49	25	11	—	M 8×16	M4	M10	0.5
A63 -SCS10-55	1	5 ~ 10	20	23.5	50	55	21	62	7.5	17	—	M10×15	M5	M10	1.1
-SCS20-55		15 ~ 20	25	28.5											
-SCD20-65	2	15 ~ 20	—	—	—	65	30	49	25	11	—	M 8×16	M4	M10	1.2
-SCD25-70		20 ~ 25				70	35	56	30	8	20				1.3
-SCD30-70		25 ~ 30					44	62	35	9	24	M10×20	M5		1.4
-SCD40-85		35 ~ 40				85	52	76	45	12	30	M12×20	M6		1.9
A100 -SCS20-70	1	12 ~ 20	29.5	34	80	70	26	99	9	20	—	M12×20	M5	M12	3.6
-SCS30-70		22 ~ 30	34.5	39											
-SCD20-70	2	15 ~ 20	—	—	—	70	30	49	25	11	—	M 8×16	M4	M10	3
-SCD25-75		20 ~ 25				75	35	56	30	8	20				3.4
-SCD30-80		25 ~ 30				80		62	35	9	24	M10×20	M5		3.5
-SCD40-90		35 ~ 40				90	45	76	45	12	30	M12×20	M6		3.9

Direct-mounting (Direct-mounting type on the machine table)

Dovetail clamping type

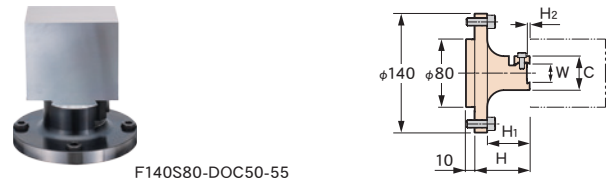

- Option
 - Mounting plate
- Note
 - Dovetail grooving of the work-piece clamping area using an angular cutter is required prior to machining. After machining, cut off the dovetail of the work-piece.
- Std access.
 - Mounting bolt×4pcs.

CODE	H	H ₁	H ₂	ϕC	W	KG
F140S80-DOC17.5-60	60	45	2	30	17.5	2.5
-DOC25 -60			3	40	25	2.6
-DOC35 -55	55	40		50	35	2.8

CODE	H	H ₁	H ₂	ϕC	W	KG
F140S80-DOC 50-55	55	40	5	70	50	3.4
-DOC 70-55				100	70	4.7
-DOC100-55			10	140	100	5.5

Flange clamping type

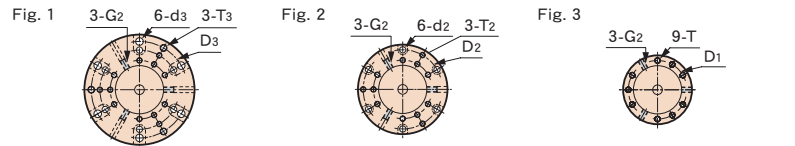
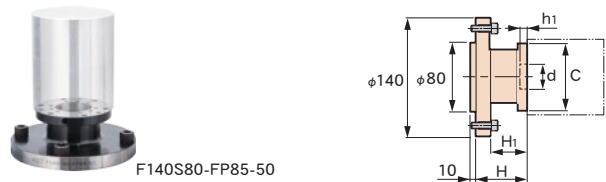

CODE	Fig.	H	H ₁	ϕC	ϕD ₁	ϕD ₂	ϕD ₃	ϕd	h ₁	T ₁	T ₂	T ₃	d ₂	d ₃	G ₂	KG
F140S80-FP 63-50	3	50	25	63	50	—	—	40	13	M5×8	—	—	—	—	M6×10	2.6
-FP 85-50	2			85		73					M6		6.6			3.1
-FP110-70	1	70	45	110			95				M6×9	M8		9		3.7
-FP130-75	2	75		130	85	115	—	70	17	M8×12	M8	—	9	—	M8×16	5.5

- Option
 - Mounting plate
 - Positioner boss → P.79
 - Adapter → P.79
- Std access.
 - Mounting bolt×4pcs.

The mounting plate is required.
 Also, we can make a custom design mounting plate.

CODE	KG
F200H80-MP140-25	4.3

The Automatic Clamping Head (Automatic exchange)

The hydraulic clamping design allows you to interchange work-pieces automatically, and makes it possible for you to combine your machining centers with robots to create a fully-automated system.

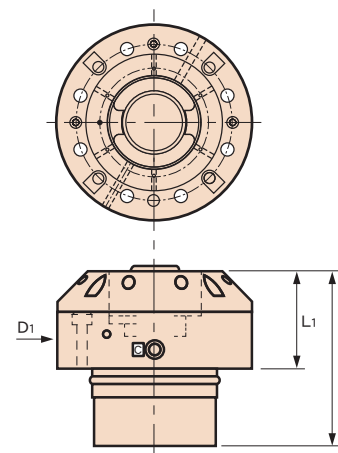
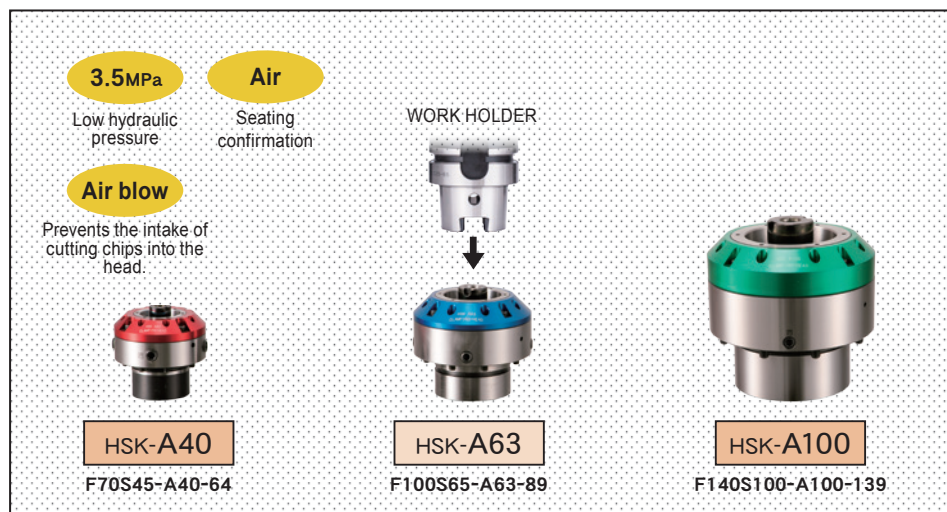

CODE	Interface	L	$\phi D1$	L ₁	Clamping force (kN)	Max. loading weight (kg)	Kg
F70S45 -A40 - 64	HSK-A40	64	70	35	6	50	1.1
F100S65 -A63 - 89	HSK-A63	89	100	50	24	140	3.1
F140S100-A100-139	HSK-A100	139	140	80	55	640	9.7

■ Note
 ● Hydraulic pressure : 3.5MPa

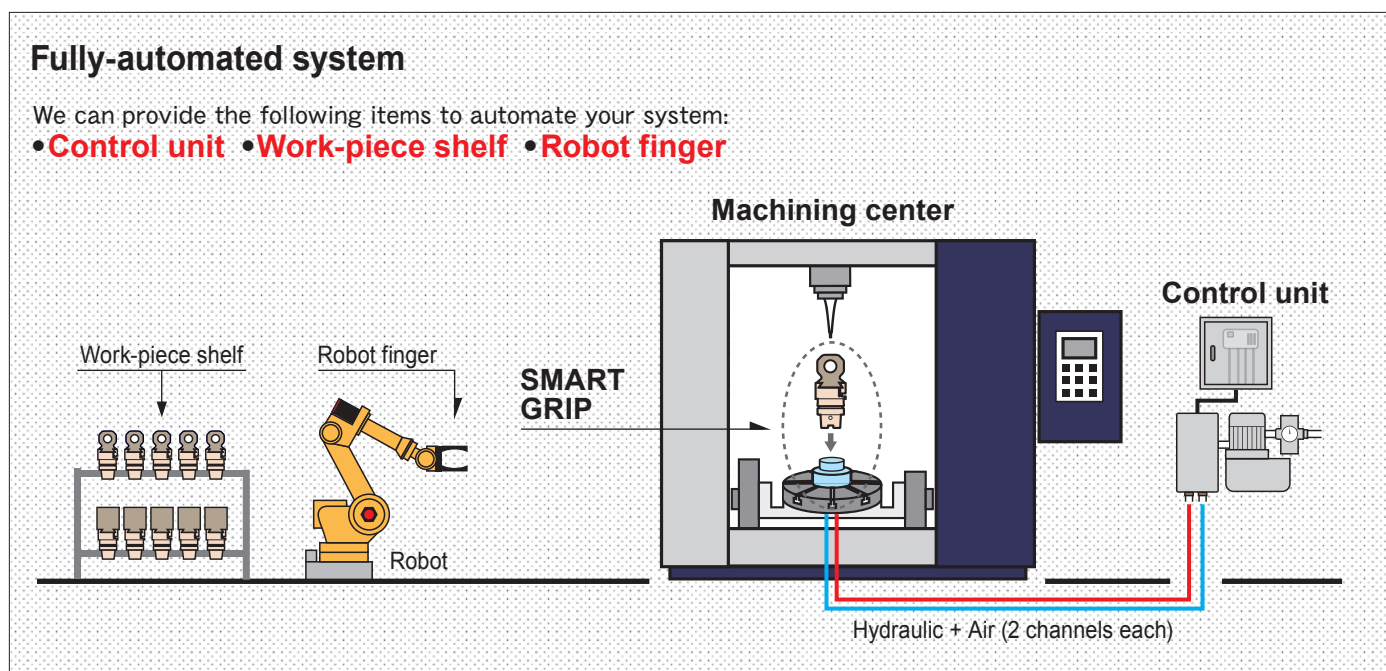
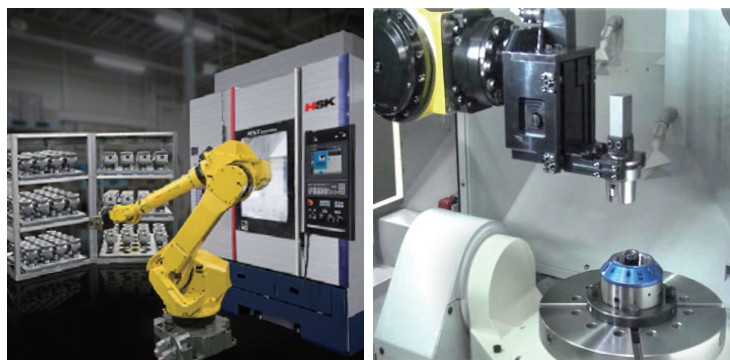
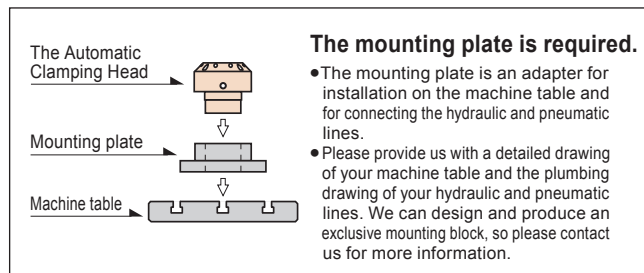

Easy and accurate Z-axis origin setting!

It is easy to accurately set the Z-axis origin of the machining center, the reference surface of work-piece, and the jig fixture.



ZPM

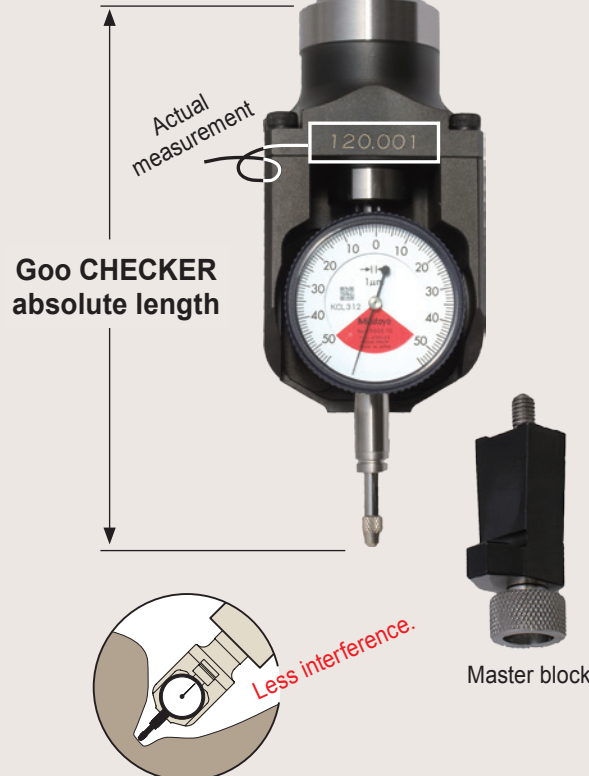

Available for using 5-axis machine.

Measuring steps are easy.

Accurate measuring of the distance from the Z-axis origin to the reference surface of the work-piece and jig fixture is easy.

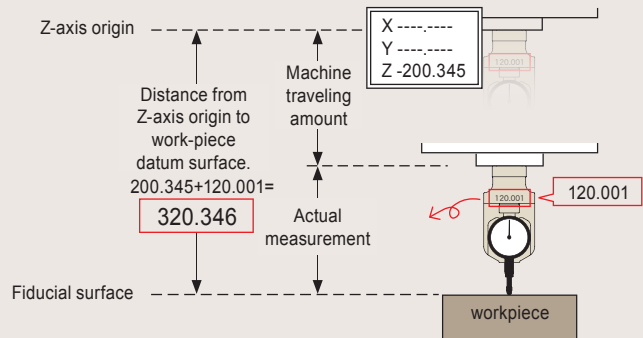

Sharable Z-axis origin for several machining centers

After measuring the distance from the Z-axis origin to the table surface of each machining center and correcting any variations, multiple machining centers can share the tool holders and programming.

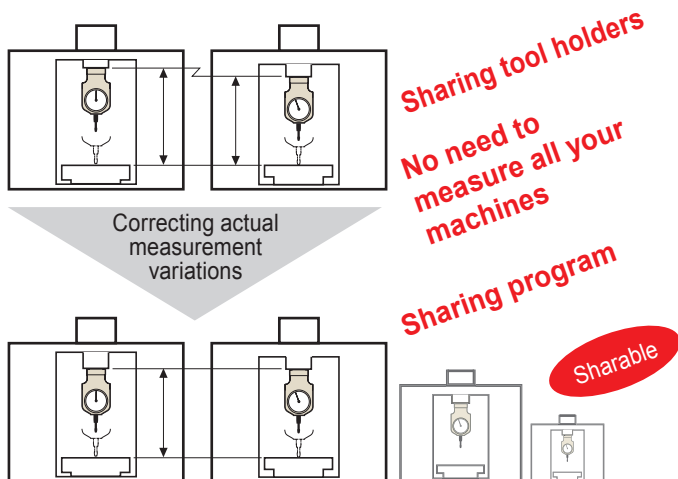

Flatness check

Precise measurement for flatness.

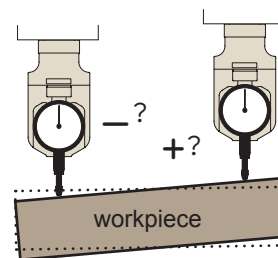

Step measurement

Measurement for steps on the work-piece.

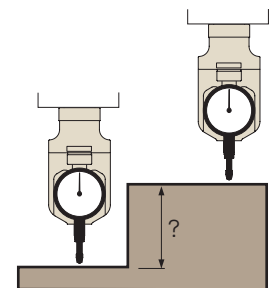

Goo Checker ZPM type (ZPM)

Thanks to its compact design, interference is reduced, making it the optimum holder for compact machining centers.



Easy confirmation of actual value (self-check function)

1. Attach the master block to the holder, and tighten the screw until it stops.
2. Adjust the dial gauge to "0".

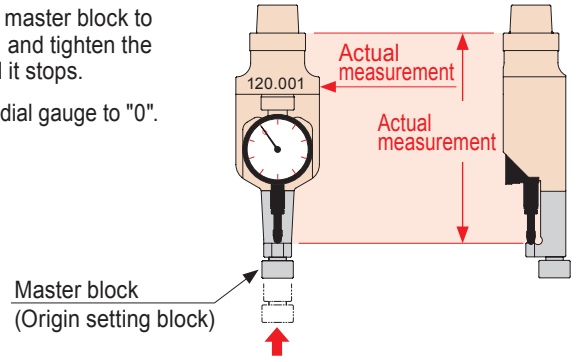

CODE	Fig.	L	L1	Kg
BT30-ZPM-130	1	130	100	1.0
-165		165	135	1.2
BT40-ZPM-150	2	150	120	1.3
-210		210	180	1.5
BT50-ZPM-180	2	180	150	2.9
-240		240	210	4.1
A63 -ZPM-150	3	150	120	1.2
-210		210	180	1.5
A100-ZPM-180	3	180	150	2.5
-240		240	210	3.8
E32 -ZPM-120	3	120	90	0.7
-165		165	135	1.0
E40 -ZPM-120	3	120	90	0.8
-180		180	150	1.1
E50 -ZPM-150	3	150	120	1.0
-195		195	165	1.3
F63 -ZPM-150	3	150	120	1.1
-210		210	180	1.3
DN40-ZPM-150	2	150	120	1.3
DN50-ZPM-180	2	180	150	2.9
CT40-ZPM-150	2	150	120	1.3
CT50-ZPM-240	2	240	210	4.1

Option

- Retention knob (BT/DIN/CAT.) → P.64

Std. Access.

- Master block
- Indicator, 1/ 1000 reading

Caution

- A.T.C is not available. (except for BT30)

Fig. 1

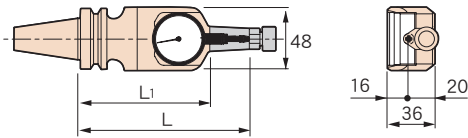

Fig. 2

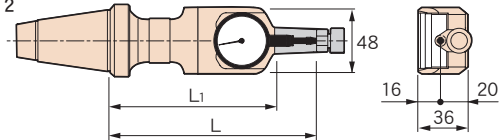
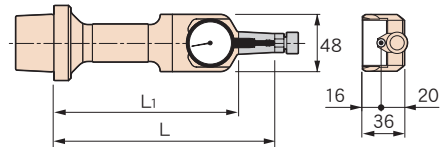
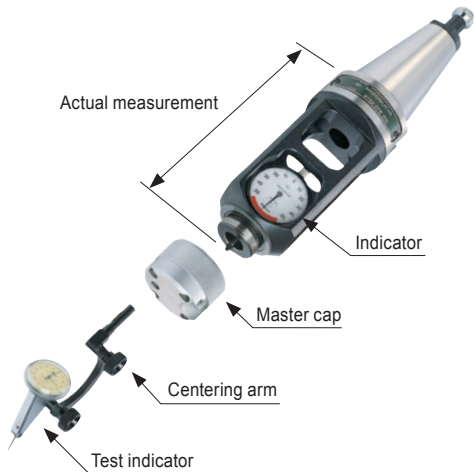

Fig. 3



Goo Checker ZPB type (ZPB)

High reliability due to its machined solid structure.



Usage example for test indicator

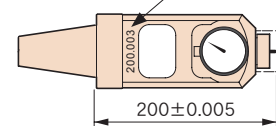
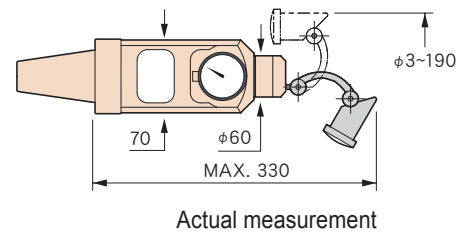

CODE	Kg
BT40-ZPB-200	3.3
BT50-ZPB-200	5.2

Option

- Retention knob → P.64

Std. Access.

- Indicator, 1/ 1000 reading
- Test Indicator, 2/ 1000 reading
- Centering arm
- Master cap
- Wooden box

Centering bar

To identify workpiece datum position

CODE

ST6-CEB102

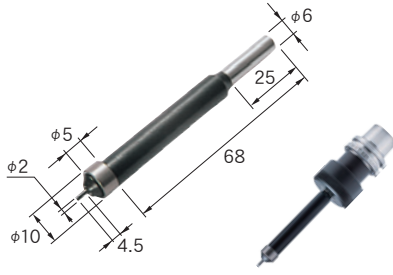

Usage

① Rotate a spindle in low-speed rotation (450~600 min^{-1})

② Contact the stylus carefully with a work-piece by micro feeding until it doesn't have a swing.

③ You can find the alignment between the machine spindle center and the work-piece edge face after the stylus moves another 1mm (the radius of dia. 2mm stylus).

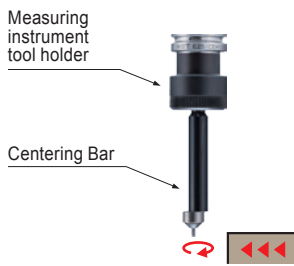

Rapid eccentricity

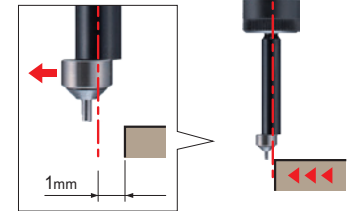

Measuring instrument tool holder (HSK-E25)

Use when centering a workpiece.

The spring collet (C10-6-P) and the centering bar (ST6-CEB102) are required and sold separately. Tighten nuts by hand.



CODE

E25-CEH10-37

Option

- Centering bar
- Spring collet (C10-6-P) → P.38

Caution

- Not usable for machining.

MAINTENANCE TOOL

TOOL CLINIC

Our engineers are here to improve your productivity by demonstrating the correct usage and maintenance of tool holders.

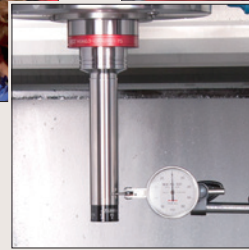
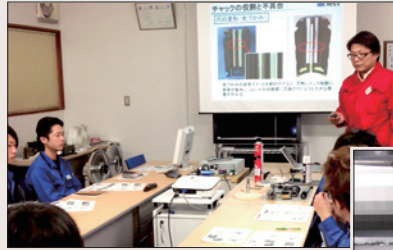

➔ P.114

TOOL SET UP STATION

Work table
6S DESK



6SD

➔ P.86

Tool washing machine
CLEAN BOX



CBX

➔ P.88

For machine spindle maintenance

**TEST BAR
CHECKMATE**

**CMA
CMB**

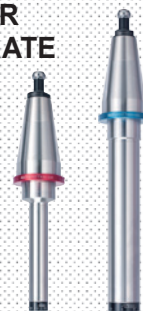

➔ P.90

TOOL CAP

**TCA
TCB
TCC**



➔ P.91

TOOL SET UP STAND

**Petit-Ball
MY CUBE
HF series**



➔ P.94

Collet stand
PALETTE

PA

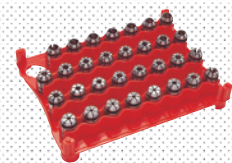

➔ P.96

ENDMILL HOUSE

EMO



➔ P.97

TOOL HOLDER STORING CABINET

HBX



➔ P.98

CODE
6SD-01

Ensures safe tool settings! Improves the work environment in the factory!

- ▷ Helps in the rapid implementation of the five S's in your factory.
- ▷ Compact and space saving.
- ▷ Do-it-yourself style allows you to do the assembly.

White board and Punched board

Useful as a bulletin board or message board, and for attaching drawings. Freely mounting position on the left or right side.

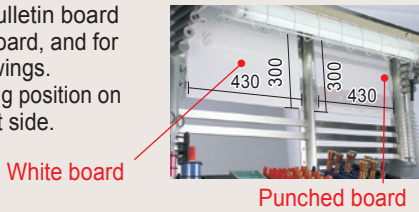

White board

Punched board

Shelf Board

Shelf is deep enough for a laptop computer, and the shelf can be attached at whatever height you desire.

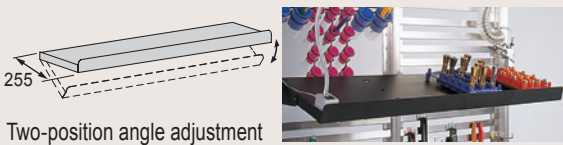

Two-position angle adjustment

Hook base panel



Arbitrary attachment and recombination



Effective utilization of a rear space

Spotlight (Option)

100V-4W desk lamp. It can be attached anywhere.

Tool insert stand (Option)

Insert and store frequently used hand tools, stationery, etc.



Tool insert stand 5 Movable model (5 pockets)



Tool insert stand 16 Fixed model (16 pockets)

Dust Shooter (Option)

Easy trash separation.

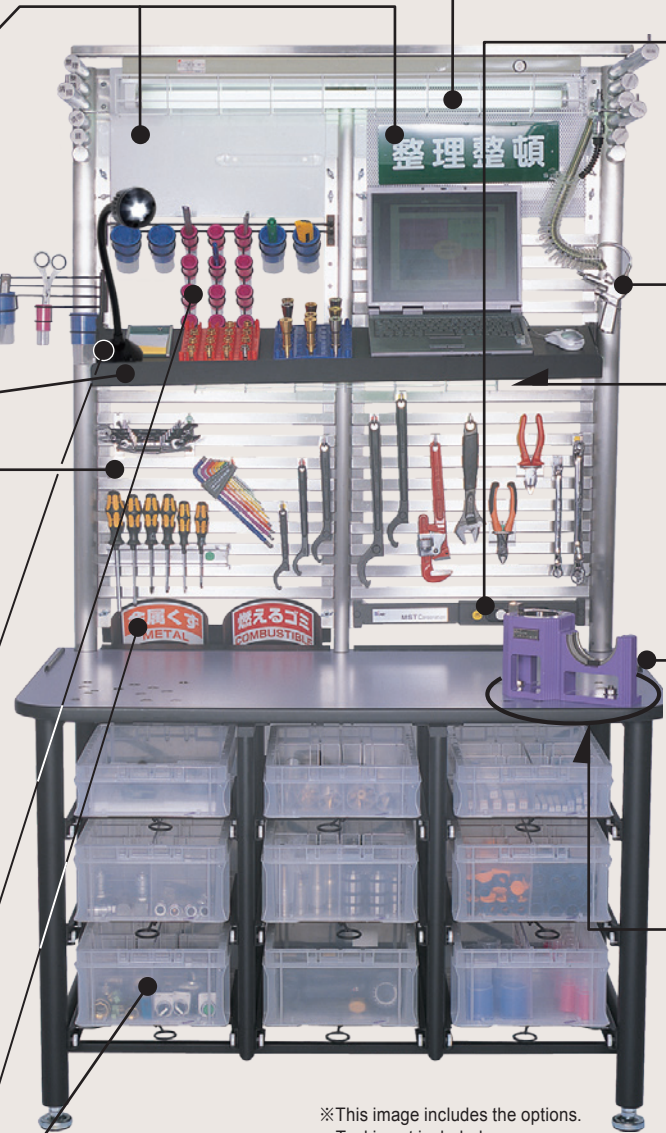

※This image includes the options. Tool is not included.

Container box

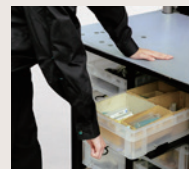

Storage



Can be removed and carried.



Organizing



The see-through box allows easy storage and organizing.

Optional dividers allow you to easily organize and systematize items.

Upper lighting

Safety light cover.

Lighting switch and socket

Upper lighting (32W) and under shelf lighting (20W) (max. capacity 1,500W)



Air gun

Can be mounted on either the right or left.

Lower lighting

Brightly lit, safe work space



Safety stopper

Prevents dropping of cutting tools and tool holders.

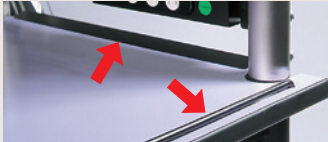

Tabletop

The tool setup stand (sold separately) can be installed anywhere using the tabletop holes. No need to put your own holes in the tabletop.

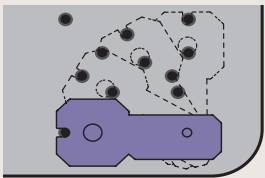

Tool set up stand

➔ P.94



MY CUBE



Petit Ball

Dimensions

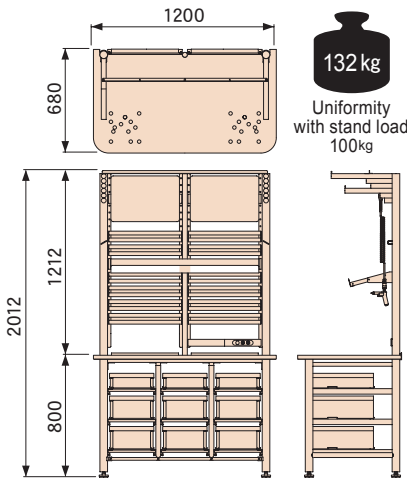

Std. Access.

CODE	Description	Q'ty	Description	Q'ty
6SD-FBP	Hook base panel	12pcs.	Shelf Board	1pc.
-FS	Short hook	3pcs.	Upper lighting / Lower lighting ※Select 50Hz or 60Hz	1ea.
-FL	Long hook	2pcs.	Power code set (Socket / Lighting / switch / Power code)	1set
-UFS	U-type short hook	3pcs.		
-UFL	U-type long hook	1pc.		
-FSP	Hook for spanner	1pc.		
-FDR	Hook for driver	1pc.	White board. Marker pen for whiteboard. Whiteboard eraser. Magnet pocket. Punched board. Name seal set. Magnets(3pcs.). Memo book.	1set
CN -103	Container box	3pcs.		
-150		6pcs.		
6SD-AIR	Air gun set	1set		

Caution

- Assembly by buyer.
- Customers pay the shipping cost.
- 100V electric power supply (transformer is required)

Option

Side table

CODE	Uniformity with stand load :40kg
6SD-STB	

Side Table for the 6S DESK

Std. Access.

- Container box (CN-103)(1pc.)
- Container box (CN-150)(2pcs.)
- Lid for Container Box (3pcs.)



Dust Shooter

CODE
6SD-DST

Comes with two kinds of sign seals.

※Trash cans are not provided.
Please prepare it by yourself.



Spotlight

CODE
6SD-SPT

100V-4W desk lamp



Tool insert stand 5

CODE	Attachment q'ty
6SD-IS5	5pcs.

5-pocket movable model



Tool insert stand 16

CODE	Attachment q'ty
6SD-IS16	16pcs.

16-pocket fixed model

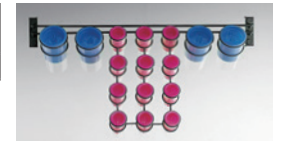

Consumables / Replacement parts

Container box

CODE	h	Capacity	Q'ty
CN-103-3	103 (88)	8 ℓ	3pcs.
-150-3	150 (135)	12 ℓ	

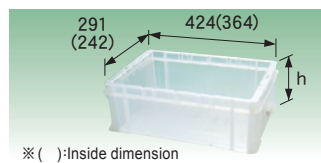

※ () : Inside dimension

Lid for container box

CODE	Q'ty
CN-FT-3	3pcs.



※Lockable

Dividers for storage cabinet

CODE	Required box	Q'ty
CN-S 84-3	CN-103	9 pcs. (for 6 rooms)
-S135-3	-150	(Container box 3 pcs. / set)

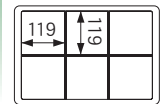

Hook base panel

CODE	Q'ty
6SD-FBP	2pcs.

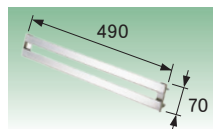

Air gun set

CODE
6SD-AIR



Hook

Short hook

CODE	Q'ty
6SD-FS	5pcs.



U-type short hook

CODE	Q'ty
6SD-UFS	5pcs.

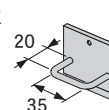

Hook for spanner

CODE	Q'ty
6SD-FSP	1pc.

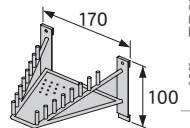

Long hook

CODE	Q'ty
6SD-FL	5pcs.

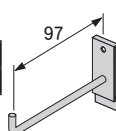

U-type long hook

CODE	Q'ty
6SD-UFL	5pcs.

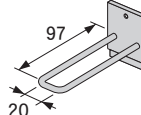

Hook for driver

CODE	Q'ty
6SD-FDR	1pc.

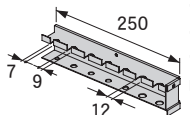

ANGLE HEAD

M/C Tool

HSK-T Tooling Systems for Turning Mill

General Purpose Tool

JIG

Measuring Equipment

Maintenance Tool

Wire EDM fixture

Technical Information

CODE
CBX-01

Wash the tooling holders, collets, nuts, cutting tools, and small work-pieces thoroughly to maintain their accuracy!

- ▷ Wash tool holders, cutting tools and jig fixtures.
- ▷ No plumbing required.
- ▷ Safe cleaning system using water.
- ▷ Built-in water heater improves washing capability.

Compact built-in sink

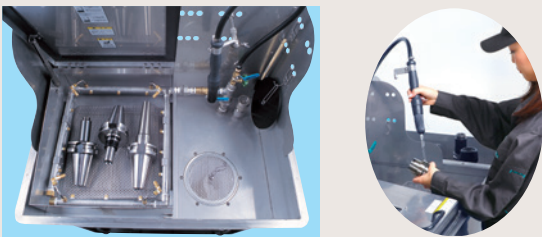

<p>Automatic washing space</p> <p>Shoots cleaning fluid from 18 location nozzles.</p>	<p>Hand washing space</p> <p>Heavy dirt can be washed off using the hand nozzle brush and hot water (40°C / 104°F)</p>	<p>Built-in sink with an overflow drain allows pre-soaked washing.</p>
--	---	--

Top cover

Top cover of washing unit can be opened and closed with one hand. Comes with an automatic shutoff function for the washing cycle. Automatic washing stops automatically when the top cover is lifted during operation.



Washing Unit

18 nozzles shoot hot water from every angle to wash off all the dirt.



Timer operating mode

Operation can be stopped automatically using the clock timer. (The time can be set arbitrarily, up to 12 min.)



※This image includes the options.

Tank

The use of heated cleaning fluid (40°C) increases the cleaning power and makes cleaning easy even in the winter.



65 liter tank.

Tank can be removed for washing.

Comes with built-in heater (3kW) standard.



Dimensions

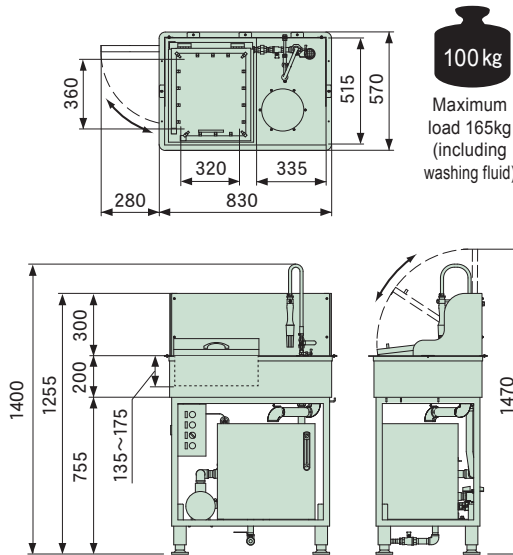

Outer sink cover

Prevents splashing of the washing cleaner.

Hand nozzle

Easy to attach and detach.

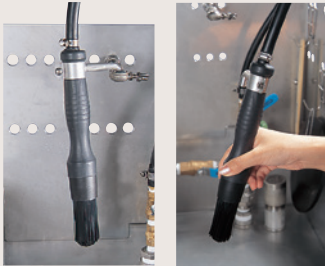

Attach

Remove

Filter

Can be changed easily when it becomes dirty.



Main filter

Sub-filter

! Be sure to use water-soluble cleaning fluid.

The sink, washing unit and tank are made of stainless steel, resulting in easy maintenance and less staining.

Specification

Material	SU304 (Sink, Tank, Cleaning unit) SS 400 (Base frame)
Tank	Approx. 65L (Level gauge with thermometer is standard accessory.)
Pump	0.3~0.51kW (50/60Hz) (Produced by Grundfos)
Heater	3kW (with temperature control)
Weight	Approx. 100kg (165kg, including cleaning fluid)
Voltage	3-phase 200V (Rated 15A)

Std. Access.

CODE	Description	Q'ty
CBX-HNZ	Hand nozzle	1pc.
-MFIL	Main filter	2pcs.
-SFIL	Sub-filter	2pcs.
-TRP	Drain trap	1pc.
-GSTP	Rubber drain plug	1pc.
-WBSK	Washing basket	1pc.
-WTBL	Washing table	1pc.
	Sink outer cover	1 set
	Hook	2pcs.
	Bamboo brush	1pc.
	Primary power code (plug attached 15m)	1pc.

Caution

- Be sure to use water-soluble cleaning fluid.
- Customers pay the shipping cost.
- 200V electric power supply (transformer is required)

Option

Draining basket

CODE	Uniformity with stand load 40kg
CBX-SBX	Std. Access. ● Triple hook

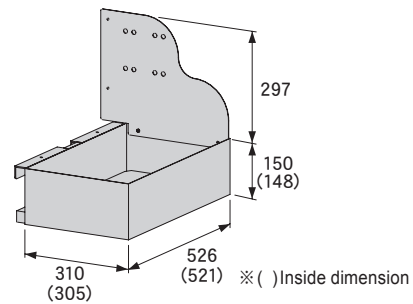

Used for draining, air blowing, rust-proofing, etc.
Can be attached to either the right or left side of the unit.

Consumables / Replacement parts

Washing basket

CODE	
CBX-WBSK	

Collet and small parts can be washed.



Washing table

CODE	
CBX-WTBL	

Used in a sink as an auxiliary table when washing by hand.

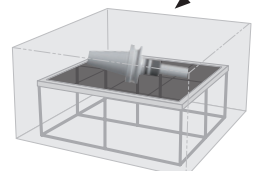
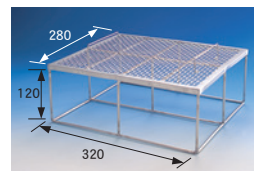

Main filter

CODE	Q'ty
CBX-MFIL	5pcs.



Hand nozzle

CODE	
CBX-HNZ	



Drain trap

CODE	
CBX-TRP	



Sub-filter

CODE	Q'ty
CBX-SFIL	3pcs.



Rubber drain plug

CODE	
CBX-GSTP	



Cleaning fluid

CODE	
CBX-EKI	



- Capacity 18 ℓ
- Product name: "Clean Super 285" weak alkaline cleaner

TEST BAR CHECKMATE

For machine spindle maintenance

The maintaining machine spindle run-out accuracy allows superior machining quality. Maximizes tool holder performance!

Periodically checking the run-out accuracy will result in superior machining.

- ▷ Light-weight (20% lighter), hollow design makes it easy to use.
- ▷ The actual measurement values are marked on the body.
- ▷ Ideal for setting Z axis datum.
- ▷ Reasonable price.

You can recognize the exact run-out accuracy and the highest run-out of the spindle.

You can check the spindle condition more precisely using the run-out value and position marked on the body.

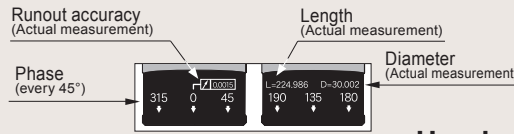

It can be installed into the spindle in every phase.

There is no drive-key groove, so measurements can be made without worrying about the phase.



The name ring and scale ring protect it from scratches and dents.

The taper area and straight area do not touch the table surface even if they are placed horizontally.

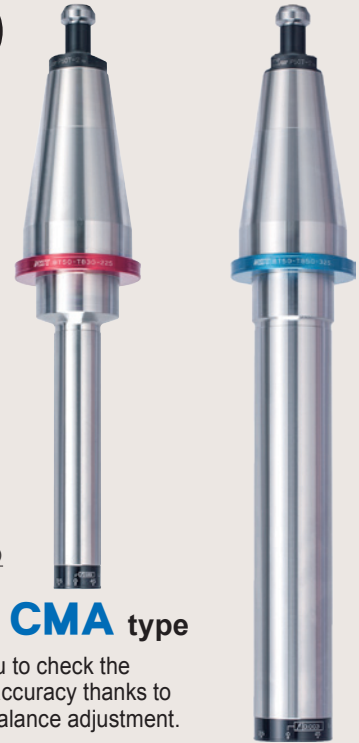
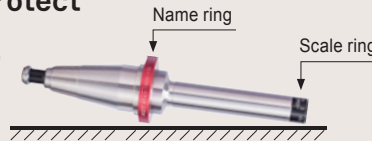

Handy CMA type

Allows you to check the dynamic accuracy thanks to optional balance adjustment.

Full-fledged CMB type

Z-axis deflection and spindle travel accuracy can be measured.

	CODE	Fig.	φD	φD1	L	L1	L2	L3	Kg
BT / DIN / CAT.	NT30 -CMA20-125	1	20	32	125	45	65	15	0.7
	NT40 -CMA25-175	2	25	42	175	50	110		1.3
	NT50 -CMA30-225		30	53	225	65	145		3.5
	NT30 -CMB30-175	1	30	32	175	45	115	15	1.0
	NT40 -CMB40-325	2	40	42	325		265		2.8
NT50 -CMB50-325		50	53		60	250		5.7	
HSK-A / -E	HSK32 -CMA20-125	3	20	26	125	35	75	15	0.4
	HSK40 -CMA20-125			32		45	65		0.5
	HSK50 -CMA25-175		25	42	175	50	110		1.0
	HSK63 -CMA25-175								1.2
	HSK80 -CMA30-225		30	53	225	65	145		2.2
	HSK100-CMA30-225								3.0
	HSK125-CMA30-225								4.1
	HSK32 -CMB25-175	3	25	26	175	35	125	15	0.7
	HSK40 -CMB30-175		30	32		40	120		0.9
	HSK50 -CMB40-225		40	42	225	45	165		1.8
HSK63 -CMB40-325				325		265		2.7	
HSK80 -CMB50-325		50	53		60	250		4.4	
HSK100-CMB50-325								5.2	
HSK125-CMB50-325								6.3	
HSK-F	HSK63F-CMA25-175	3	25	42	175	50	110	15	1.2
	HSK80F-CMA30-225		30	53	225	65	145		2.3
	HSK63F-CMB40-325	3	40	42	325	45	265	15	2.7
	HSK80F-CMB50-325		50	53		60	250		4.5

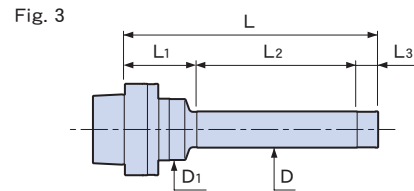
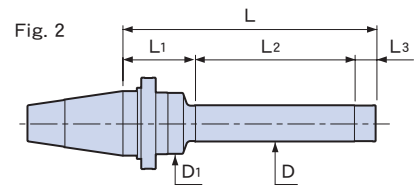
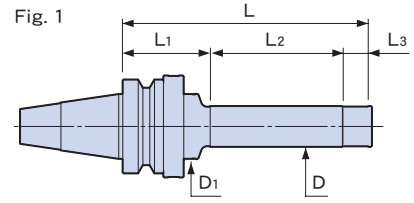

Exclusive retention knob

CODE	Shank
P-576	CAT.40
-575	CAT.50
-578	DIN40
-577	DIN50

- Option
 - Coolant duct (HSK-A)
 - Retention knob (BT)
 - Exclusive retention knob (CAT. / DIN)
 - Balance adjustment (only for CMA type) less than G2.5 / 30000min⁻¹
 ※ Please order by adding "BL" to the end of the code.
 (Ex.: HSK63-CMA25-175 BL)
- Std. Access.
 - Accuracy inspection sheet

- Note
 - NT type is available for BT/CAT. and DIN spindle by changing the retention knob.
 - HSK type is available for both HSK-A and HSK-E spindles.
 - HSK-F type is available only for HSK-F spindle.
 - A special design retention knob is required for CAT./DIN spindle. A market standard retention knob for ANSI/DIN/ISO is not available. Contact us for the details.
 - Use a market standard retention knob for the BT spindle.
 - NT30 type can be installed into a spindle at 0° and 180°.
- Caution
 - A.T.C is not available. (except for NT30)

The sub-zero treatment prevents secular change.

See-through tool cover. You can take care of your tools safely and simply.

- ▷ Prevent cutting tools from coming into contact with each other and being damaged or chipped.
- ▷ Prevent getting injured when taking the tool holder in and out or when carrying.
- ▷ Minimize grinding costs for reconditioning and lead to reduced operating costs.
- ▷ Applicable for various shapes or brands.

TCC type
Attached by deforming its cap.

TCB type
Attaches directly to the tip of the cutting tool.

TCA type
Attaches to the tip of a tool holder.



The tool is visible

The cutting tools can be stored with the caps on. By placing the cap on the tip of the tool holder, the cutter doesn't receive any stress, alleviating any worries over the cutters breaking.



Prevents chipping and damage to cutting tools

Storing cutters with caps will prevent them from hitting each other and being chipped. This will minimize grinding costs for reconditioning and lead to reduced operating costs.

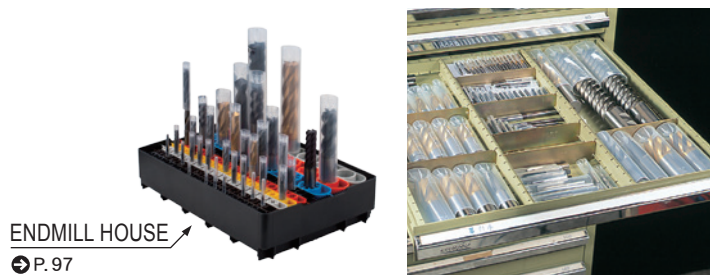

Will not slip off

Can be put on with one touch, and won't fall off when turned upside down.



It can be used with every configuration and brand.





TCA type

Attaches to the tip of a tool holder.

ANGLE HEAD



TCA2022 TCA2830 TCA3436 TCA4043 TCA4650

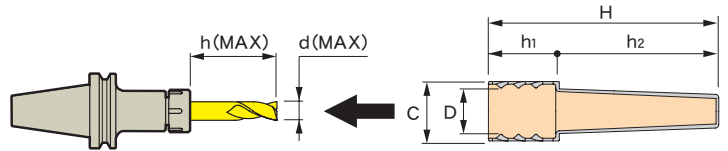

Code system

TCA	2030 (Min.~MAX.)	—	50 (pc)
	D dimension		Q'ty

M/C Tool

CODE	φD	φC	φd	H	h	h1	h2	Type	Note
TCA2022	20~22	29	8	100	70	30	70	DTA7/DTB7	10pcs. 50pcs. 100pcs.300pcs. 500pcs. Please order by adding Q'ty to the end of the code. Ex. TCA2022-10
TCA2830	28~30	34	14	130	90	40	90	DTA12/DTB12/DTE7	
TCA3436	34~36	41		135		45		CTA10/CTH10	
TCA4043	40~43	47	20	152	105	47	105	DTE12	
TCA4650	46~50	54		167	120		120	CTA20/CTH20	

Cap dispenser

Tool caps can be easily removed from the dispenser.

Dispenser exclusively for storing TCA-type tool caps. Made of transparent acrylic resin, allowing you to confirm which caps are still in the dispenser.

HSK-T Tooling Systems for Turning Mill

General Purpose Tool

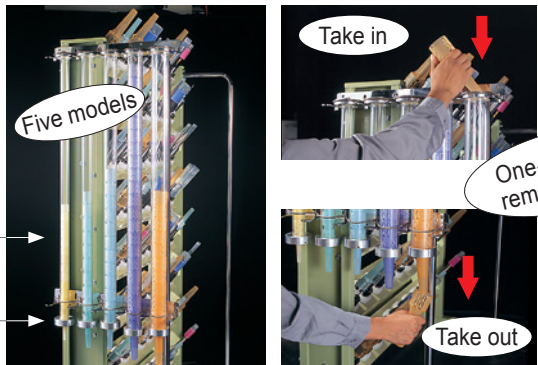

Cap dispenser

Dedicated bracket

Cap dispenser

Five models available for different sizes.

CODE	Type	Q'ty
CAP2022	TCA2022	31pcs.
CAP2830	TCA2830	20pcs.
CAP3436	TCA3436	
CAP4043	TCA4043	22pcs.
CAP4650	TCA4650	

Dedicated bracket

Five cap servers can be attached. Attach the bracket to a wall using bolts.

CODE
SRV-01

JIG

TCB type

Attaches directly to the tip of the cutting tool. Handles a broad range of sizes.

Measuring Equipment

Maintenance Tool

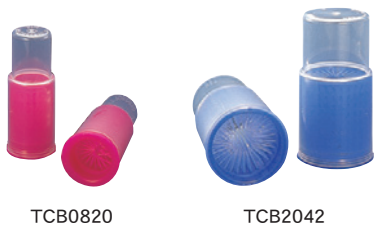

TCB0820

TCB2042

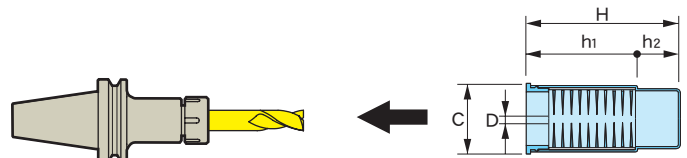

Code system

TCB	2042 (Min.~MAX.)	—	300 (pc)
	D dimension		Q'ty

Wire EDM fixture

CODE	φD	φC	H	h1	h2	Note
TCB0820	8~20	33	82	52	30	10pcs. 50pcs. 100pcs. 300pcs. 500pcs. Please order by adding Q'ty to the end of the code. Ex. TCB0820-10
TCB2042	20~42	54	102	62	40	

Note

- The bristles of the brush may become deformed during use. If such deformation occurs, remove the brush and immerse it in hot water (60°C to 80°C). This should restore the deformed bristles to their original state.

Technical Information

TCC type

Attached by deforming its cap.
Simple and reasonably priced.
For small size tool holders and cutting tools.

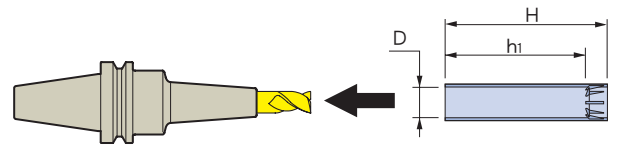
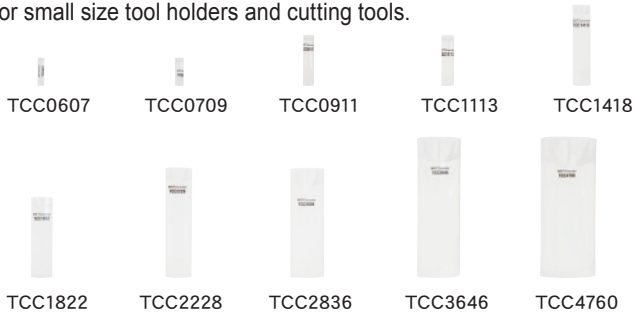

Code system	TCC	2228 (Min.~MAX.)	—	100 (pc)
		D dimension		Q'ty

Variety set

CODE	Q'ty
TCC-F	2 pieces per cutting tool cover size for TCC0607 to 4760 (Total of 20 pieces / set)

CODE	φD	h ₁	H	Q'ty
TCD03-50	3	—	25	50 pcs.
TCD04-50	4	—	32	50 pcs.
TCC0607- 50	5.4~ 6.7	35	40	50 pcs.
-100				100 pcs.
-500				500 pcs.
TCC0709- 50	6.8~ 8.9	35	40	50 pcs.
-100				100 pcs.
-500				500 pcs.
TCC0911- 50	8.9~ 10.9	65	70	50 pcs.
-100				100 pcs.
-500				500 pcs.
TCC1113- 50	10.9~ 13.4	65	70	50 pcs.
-100				100 pcs.
-500				500 pcs.
TCC1418- 25	13.8~ 17.8	100	110	25 pcs.
- 50				50 pcs.
-250				250 pcs.
TCC1822- 25	17.8~ 22.4	100	110	25 pcs.
- 50				50 pcs.
-250				250 pcs.
TCC2228- 25	22.3~ 28	135	150	25 pcs.
- 50				50 pcs.
-250				250 pcs.
TCC2836- 10	28 ~ 36	130	150	10 pcs.
- 20				20 pcs.
- 50				50 pcs.
-200				200 pcs.
TCC3646- 10	36.2~ 47	165	190	10 pcs.
- 20				20 pcs.
- 50				50 pcs.
-200				200 pcs.
TCC4760- 10	46 ~ 60	160	190	10 pcs.
- 20				20 pcs.
- 50				50 pcs.
-200				200 pcs.

Usage

1. Hold the mouth of the tool cap vertically, and then press it so that its oval shape becomes round.
2. Once the mouth of the tool cap becomes round, push it into the cutting tool or tool holder.



You can cut it to any desired length.

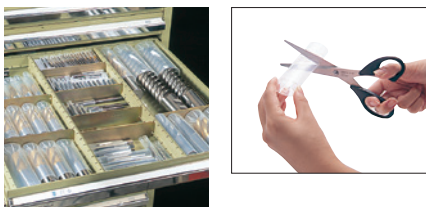

Tool set up stand

Tool tightening stand

The setup time can be shortened! Not only can you mount cutting tools simply and quickly without using other tools, but also clamping collets and retention knobs!

7.7ボール
Petit Ball 40
BT40/DIN40/CAT.40

Freely set vertically or horizontally

マキユブ
My CUBE 50
BT50/DIN50/CAT.50
マキユブ
My CUBE 100
HSK-A100/T100

Vise clamping type
HF SERIES

BT30/BT40/BT50
HSK A40/A50/A63/A100
E32/E40/E50/F63
T40/T50/T63/T100

Affordable



M/C Tool

HSK-T Tooling Systems for Turning Mill

General Purpose Tool

Usable either vertically or horizontally (Petit Ball, My CUBE)

The tool can be placed either vertically or horizontally, whatever angle is most convenient for you.

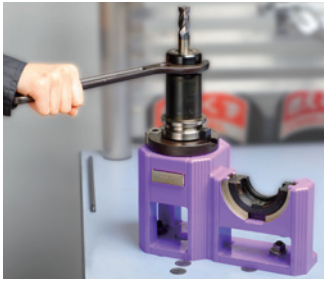

Nut tightening



Clamping DETa-1 Collet(DTB)



Retention knob tightening



Clamping SLIMLINE collet

JIG

Measuring Equipment

Maintenance Tool

Multi-purpose usage

By using adapters, various tool holder shank types, including straight arbor DTB holders, can be used.

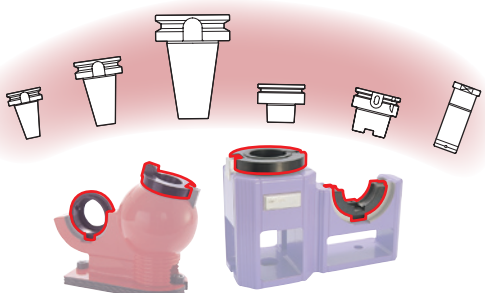

Accuracy assured

The taper is the most crucial part for maintaining the accuracy of a tool holder. A special resin is applied to the taper contact area to prevent scratches on the tool holder.



Wire EDM fixture

Technical Information

Petit Ball

CODE	Shank type	
Petit Ball40	BT40/DIN40/CAT.40	6.1

- **Option**
 - Adapter
- **Std. Access.**
 - Name plate
- **Caution**
 - No mounting bolts are provided. Use two M8 bolts for mounting.

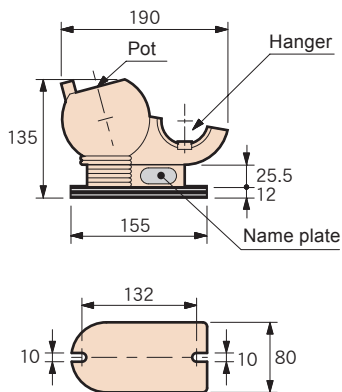

Name plate

A specially finished name plate is provided, on which your company name is inscribed. Up to 12 characters (upper-case alphabetic characters, numeric characters, and/or hyphens).



Adapter (Petit Ball)



Adapter for pot

CODE	Shank type
AP40-T30V	BT30

Adapter for hanger

CODE	Shank type
AP40-T30H	BT30
-S25H	ST25T-DTB7
-S32H	ST32T-DTB7, 12

MY CUBE

CODE	Shank type	
MY CUBE 50	BT50 / DIN50 / CAT.50	9.7
MY CUBE100	HSK-A100, T100	9.6

- **Option**
 - Adapter
- **Std. Access.**
 - Name plate
- **Caution**
 - No mounting bolts are provided. Use two M12 bolts for mounting.

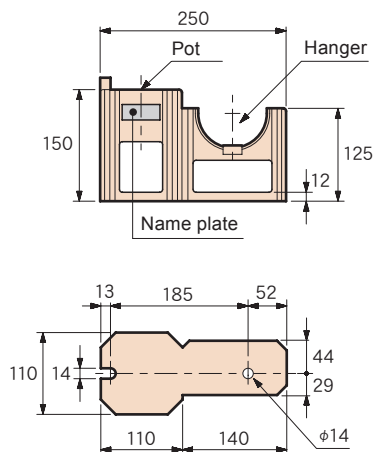

Name plate

A specially finished name plate is provided, on which your company name is inscribed. Up to 12 characters (upper-case alphabetic characters, numeric characters, and/or hyphens).



Adapter (MY CUBE50)



Adapter for pot

CODE	Shank type
AP50-T30V	BT30
-T40V	BT40/DIN40/CAT.40
-A63V	HSK-A63, T63
-F63V	HSK-F63

Adapter for hanger

CODE	Shank type
AP50-T30H	BT30
-T40H	BT40
-A63H	HSK-A63, T63
-F63H	HSK-F63
-S25H	ST25T-DTB7
-S32H	ST32T-DTB7, 12

HF series

CODE	Fig.	Shank type	H	W	t	
HF-BT30	1	BT30	77	70	30	0.8
-BT40		BT40	90	90	37	1.2
-BT50		BT50	—	—	—	2.2
HF-A40	1	HSK-A40, T40	72	60	30	0.8
-A50		-A50, T50	77	70	37	1.0
-A63		-A63, T63	87	90	—	1.2
-A100		-A100, T100	—	—	—	2.1
HF-E32	3	HSK-E32	98	64	—	1.0
-E40		-E40	100	70	—	1.1
-E50		-E50	106	80	—	1.3
-F63		-F63	120	90	—	1.6

Fig. 1

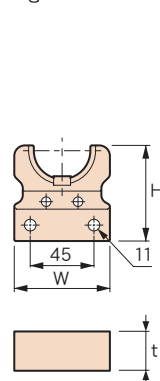

Fig. 2

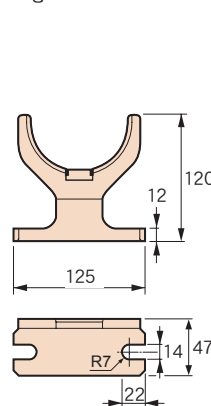
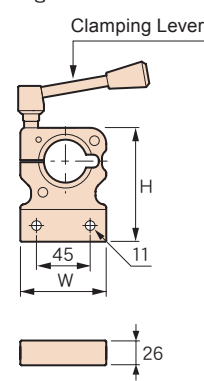
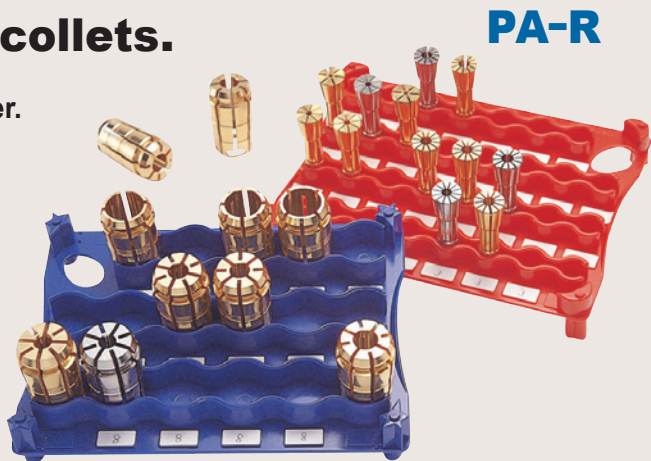

Fig. 3



This pallet neatly houses collets.

- ▷ Uniquely designed by an industrial designer.
- ▷ Protects the collets from damage to maintain their accuracy.
- ▷ Both top side and back side are usable.
- ▷ Affixing labels allows easy storage by size.
- ▷ Has standard outer dimensions ensuring applicability to various types of drawers and shelves.
- ▷ Applicable regardless of manufacturer.



PA-R

PA-B

Neatly arranged by size



A stand for the SLIMLINE 2PIECE type collets is also available.



PA-R

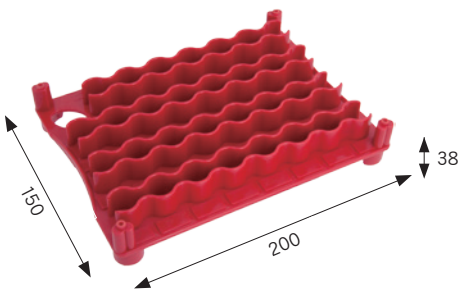

PA-B

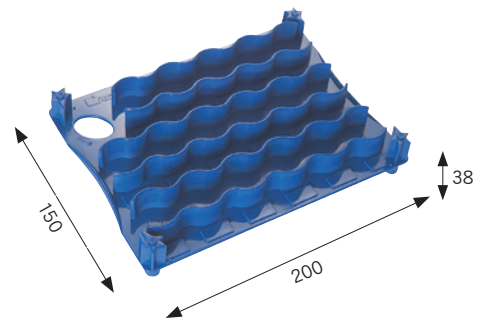

Storage side of Spring collet (C10)

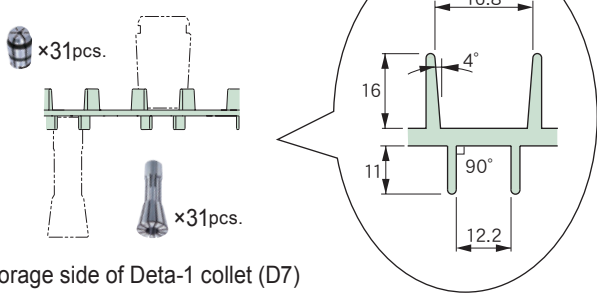

Storage side of Spring collet (C20)

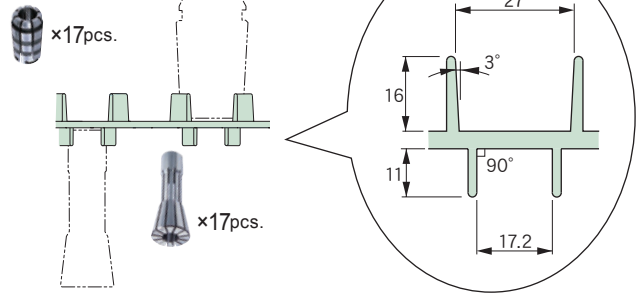

Storage side of Deta-1 collet (D7)

Storage side of Deta-1 collet (D12)

CODE	Q'ty
PA-R- 1	1pc.
- 5	5pcs.
-10	10pcs.

CODE	Q'ty
PA-B- 1	1pc.
- 5	5pcs.
-10	10pcs.

Are you having trouble storing your cutting tools ?

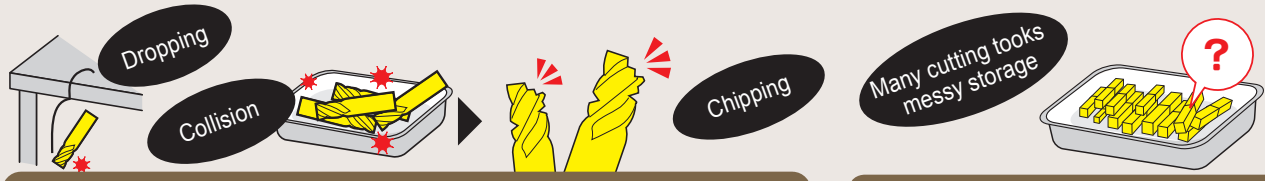

Cutting tool expenses increase due to cutting edge chipping.

The required cutting tool cannot be found easily.

Save cutting tool expenses and time with the optimum working environment!

- ▶ Cutting tool life is extended because the cutting edge is not dulled from striking other cutters.
- ▶ You can find the required cutting tool immediately.

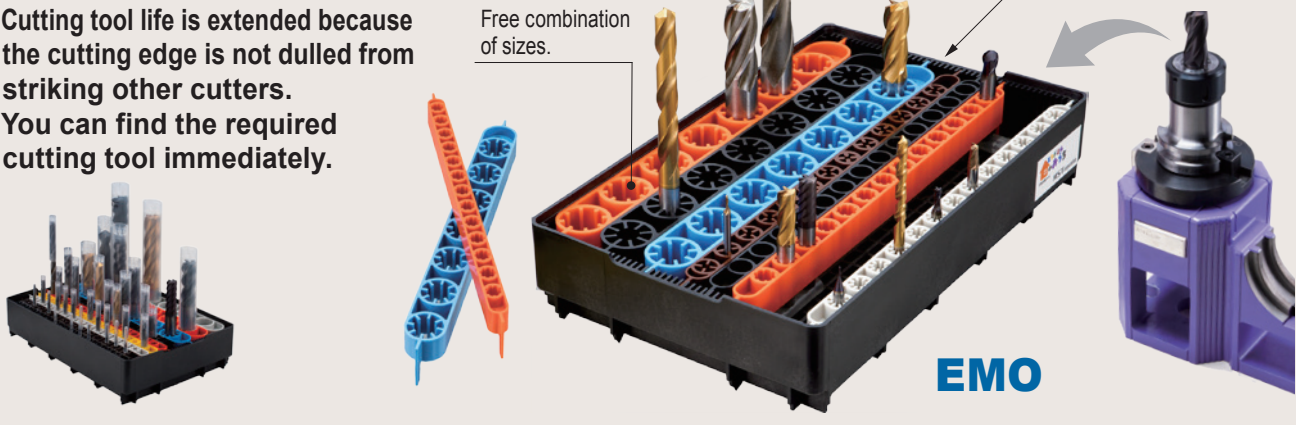

Value set

This is a convenient value set that can be immediately used and handles tool shank diameters of 3 mm to 12 mm. (Stores 156 cutting tools)

CODE	Stand	Base	TOOL CAP	TOOL CAP storage box																														
EMO-SET-01	<table border="1"> <thead> <tr> <th>Cutter dia</th> <th>Q'ty</th> </tr> </thead> <tbody> <tr><td>φ 3</td><td>1pc.</td></tr> <tr><td>φ 4</td><td>2pcs.</td></tr> <tr><td>φ 6</td><td>3pcs.</td></tr> <tr><td>φ 8</td><td>2pcs.</td></tr> <tr><td>φ 10</td><td>2pcs.</td></tr> <tr><td>φ 12</td><td>2pcs.</td></tr> </tbody> </table>	Cutter dia	Q'ty	φ 3	1pc.	φ 4	2pcs.	φ 6	3pcs.	φ 8	2pcs.	φ 10	2pcs.	φ 12	2pcs.	1pc.	<table border="1"> <thead> <tr> <th>Cutter dia</th> <th>Q'ty</th> </tr> </thead> <tbody> <tr><td>φ 3</td><td>50pcs.</td></tr> <tr><td>φ 4</td><td>50pcs.</td></tr> <tr><td>φ 6</td><td>50pcs.</td></tr> <tr><td>φ 8</td><td>50pcs.</td></tr> <tr><td>φ 10</td><td>50pcs.</td></tr> <tr><td>φ 12</td><td>50pcs.</td></tr> </tbody> </table>	Cutter dia	Q'ty	φ 3	50pcs.	φ 4	50pcs.	φ 6	50pcs.	φ 8	50pcs.	φ 10	50pcs.	φ 12	50pcs.	<table border="1"> <thead> <tr> <th>Q'ty</th> </tr> </thead> <tbody> <tr><td>1pc.</td></tr> </tbody> </table>	Q'ty	1pc.
	Cutter dia	Q'ty																																
	φ 3	1pc.																																
	φ 4	2pcs.																																
	φ 6	3pcs.																																
	φ 8	2pcs.																																
φ 10	2pcs.																																	
φ 12	2pcs.																																	
Cutter dia	Q'ty																																	
φ 3	50pcs.																																	
φ 4	50pcs.																																	
φ 6	50pcs.																																	
φ 8	50pcs.																																	
φ 10	50pcs.																																	
φ 12	50pcs.																																	
Q'ty																																		
1pc.																																		
<p>φ 3...13pcs. φ 4...26pcs. φ 6...39pcs. φ 8...26pcs. φ 10...26pcs. φ 12...26pcs.</p>																																		

Stand

Parts for storing and securing cutting tools. It is possible to identify the cutting tool size by color, and the cutting tool you need can be found at a glance. Use this stand inserting it into the base.

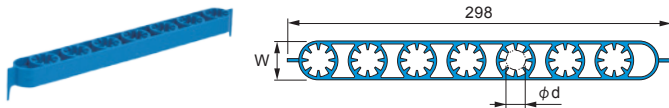

CODE	φd	W	max. Q'ty	Color	Q'ty
EMO-STD 3-2	3	15mm (1W)	13 pcs./cutting tools/stand	Black	2pcs.
-5	Black			5pcs.	
-STD 4-2	4			Brown	2pcs.
-5	Brown			5pcs.	
-STD 6-2	6			Gray	2pcs.
-5	Gray			5pcs.	
-STD 8-2	8	30mm (2W)	7 pcs./cutting tools/stand	Yellow	2pcs.
-5	Yellow			5pcs.	
-STD10-2	10			Orange	2pcs.
-5	Orange			5pcs.	
-STD12-2	12			Black	2pcs.
-5	Black			5pcs.	
-STD16-2	16	30mm (2W)	7 pcs./cutting tools/stand	Blue	2pcs.
-5	Blue			5pcs.	
-STD20-2	20			Orange	2pcs.
-5	Orange			5pcs.	
-STD25-2	25			Gray	2pcs.
-5	Gray			5pcs.	

Base

Container for holding the stands. Stands can be arranged by changing the combination of stands freely.

CODE	Q'ty
EMO-BAS-1	1pc.
-3	3pcs.

Note

- 12 rows for the stands of 3mm to 12mm diameter or 6 rows for the stands of 16mm to 25mm diameter.
- The left-right orientation of the stands can be set.

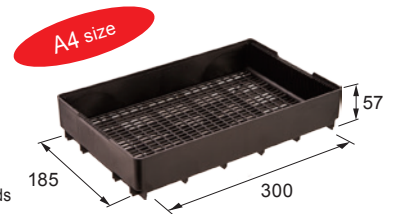

Example of stand arrangement

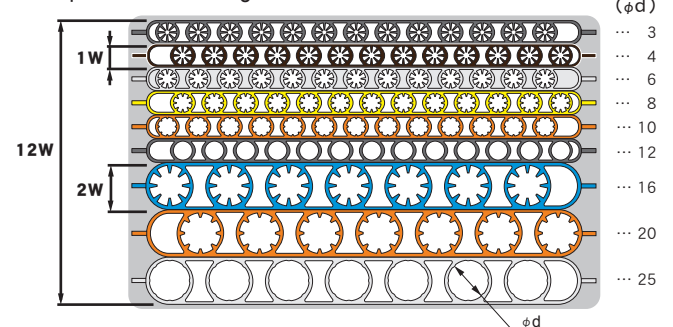

TOOL HOLDER STORING CABINET

Compact Storage Box with Anti-Rust Treatment for tool holders.

Orderly storing with name plate!

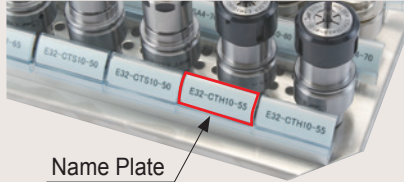

Name Plate

Transparent case!!



Freely arrangeable

Can be used with a variety of holders by changing the pins and combining as you wish.

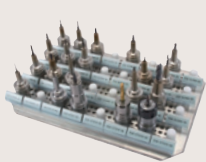

Horizontal type



Vertical type

HBX

Three types of container boxes.

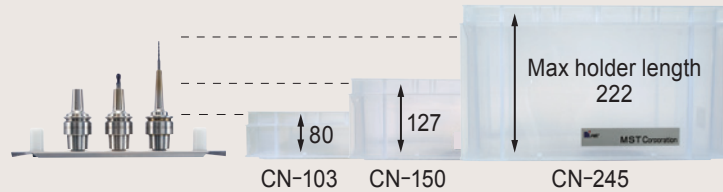

Standard Set

CODE	max. Q'ty	Container box	Pin	Q'ty	Shank type
HBX-A40	24	CN-150	HBX-PNE40	18pcs.	HSK-A40
-A50	15	-245	-PNE50	15pcs.	-A50
-E25	40	-150	-PNE25	32pcs.	-E25
-E32			-PNE32		-E32
-E40	24		-PNE40	18pcs.	-E40
-E50	15	-245	-PNE50	15pcs.	-E50
-F63	10				-F63
-15T	40	-150	-PN15T	16pcs.	15T(BROTHER)
-20T			-PN20T		RS20/20T(SUGINO)

■ Contents of set

- Base plate ●Container box ●Pin

■ Option

- Rail ●Name plate
- Lid for container box ●Eyenut

■ Note

- Knock-down type. A wrench (5mm) is required.

Base plate

A multi-hole base plate is employed. Supports a variety of holder specifications using pins that can be freely changed and relocated.

CODE
HBX-BP01

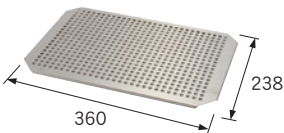

Container box

CODE	H		Shank type
	Outside diameter	Inside diameter	
CN-103	103	88	—
-150	150	135	E25, 32, 40/15T/20T
-245	245	230	A50, E50, F63

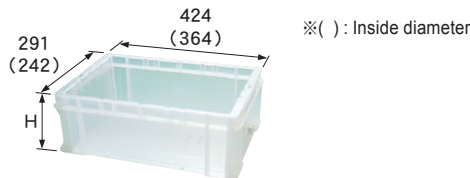

Pin

CODE	Q'ty	Size
HBX-PNE25	10 pcs.	φ 13.5 × H20
-PNE32		φ 16.5 × H25
-PNE40	5 pcs.	φ 20.5 × H29
-PNE50		φ 25.5 × H36
-PN15T		φ 26.5 × H54
-PN20T		φ 30.5 × H62

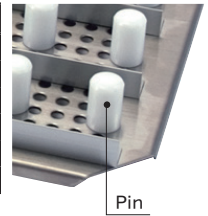

■ Std. Access.

- Mounting bolt (M6)

Eyenut

CODE	Q'ty
HBX-ENM6	2pcs.

- Std. Access.
- Mounting bolt (M6)

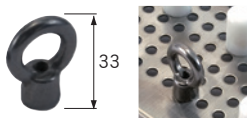

Rail (for name plate)

CODE	Q'ty	L	Note
HBX-R210	6pcs.	210	Vertical type
-R330	4pcs.	330	Horizontal type

- Std. Access.
 - Mounting bolt (M5)
- Required for attaching name plate.

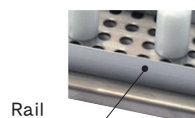

Name plate

CODE	Q'ty
HBX-NP01	40pcs.

Useful for organizing tools. Attaches easily to the rail.

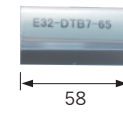

Lid for container box

CODE
CN-FT



A work-piece fixture with high-accuracy positioning and short setup time.

MIDDLE VISE

- ▷ Ideal for small work-pieces.
- ▷ High flexibility in choosing installation place compact design.
- ▷ After the work-piece is clamped, horizontal and parallel adjustments are possible due to the independent fine adjustment functionality.
- ▷ Two sliders makes it easy use to use.

Compact design

This product does not use a table corner, allowing it to be installed in any place. Multiple pieces may be installed.

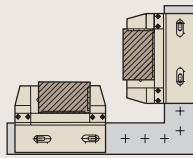

Height adjusting mechanism

The clearance between the zero level of the table and the level of the workpiece can be set to 0 or 1 mm.

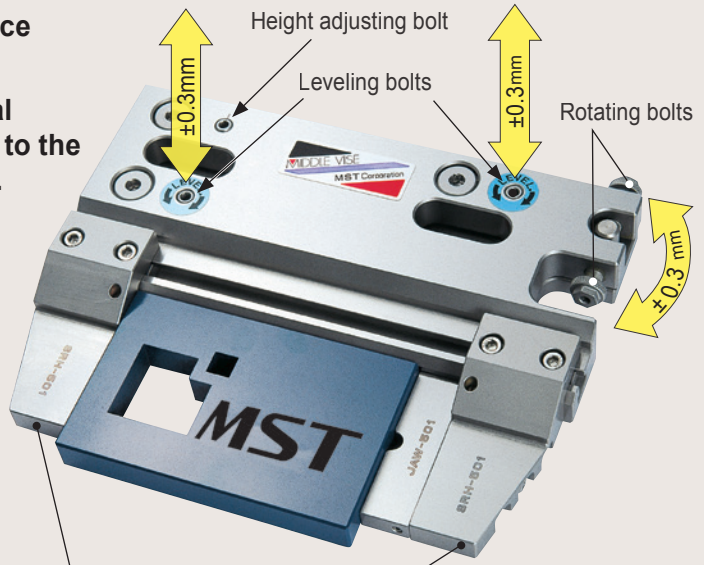
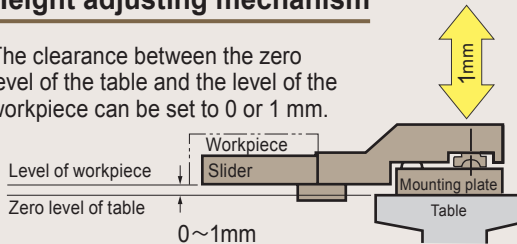

The Two-slider system allows you to set it up anywhere.

Standard set

CODE

MDV-501

Description

1. A complete set of main body (Including 2 sliders and 1 jaw)
2. Allen wrench (1 each: 2.5, 4, and 6 mm)
3. 10 mm spanner (1pc.)
4. M8 mounting bolts and washers (25 ea.)

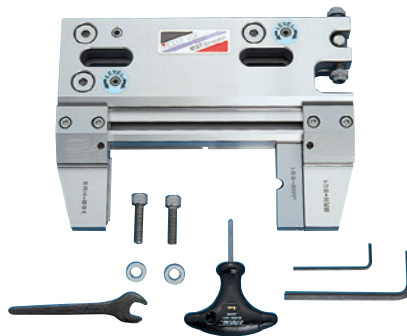

Specification

This unit uses stainless steel that is highly resistant to corrosion and wear.

Maximum dimensions of work-piece	130×100
Maximum weight of work-piece	3kg
Weight of main body	5kg
Material	SUS420J2
Hardness	50HRC

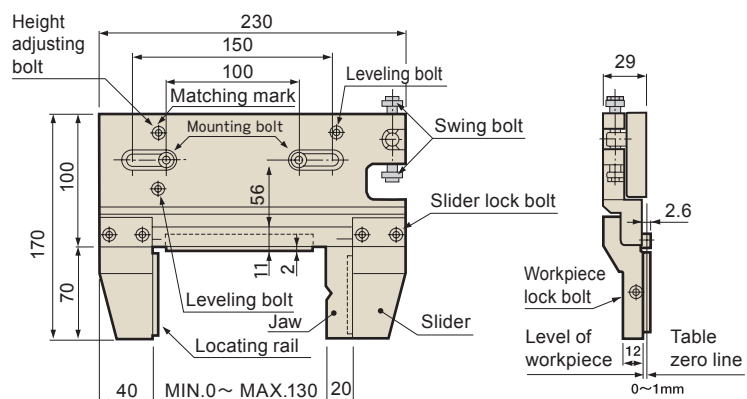

Optional accessories

Name	Model No.		Dimensions	work-piece size
Extension Jaw For large work-pieces	JAE-501			
L Slider For small work-pieces	SRL-501			
V Slider For round work-pieces	SRV-501			
Sandwich Slider For small and thin work-pieces	SRS-501			
Clamp on Slider The work-piece can be clamped to the jaw using the clamber. The extension plate can also be used.	SRC-501			

ANGLE HEAD
M/C Tool
HSK-T Tooling Systems for Turning Mill
General Purpose Tool
JIG
Measuring Equipment
Maintenance Tool
Wire EDM fixture
Technical Information

A work-piece fixture with high-accuracy positioning and short setup time.

- ▷ A work-piece having a datum surface can be accurately attached by merely affixing it to the wire cut unit body.
- ▷ You can clamp a work-piece quickly.
- ▷ After the work-piece is clamped, horizontal and parallel adjustments are possible due to the independent fine adjustment functionality.

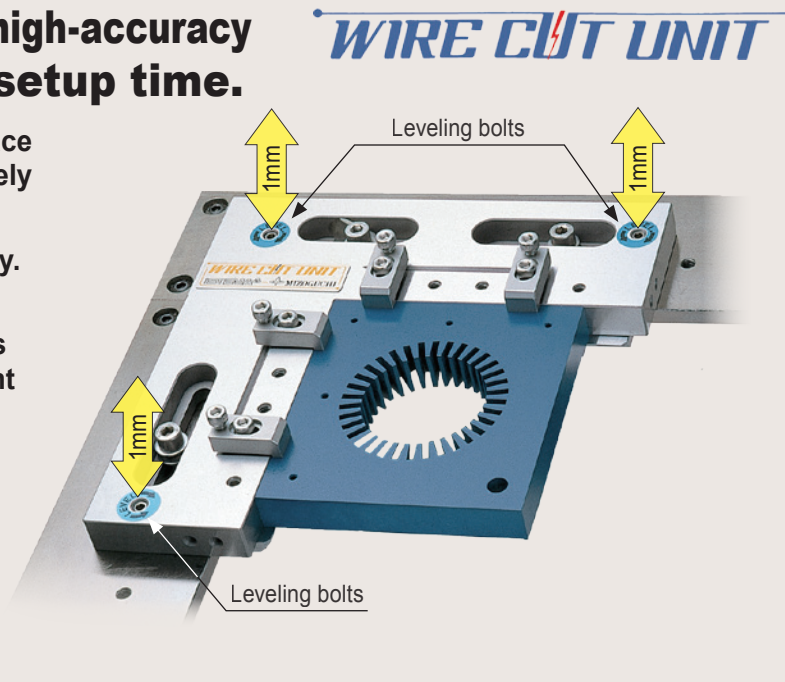

Wire Cut Unit set

WCU - A set

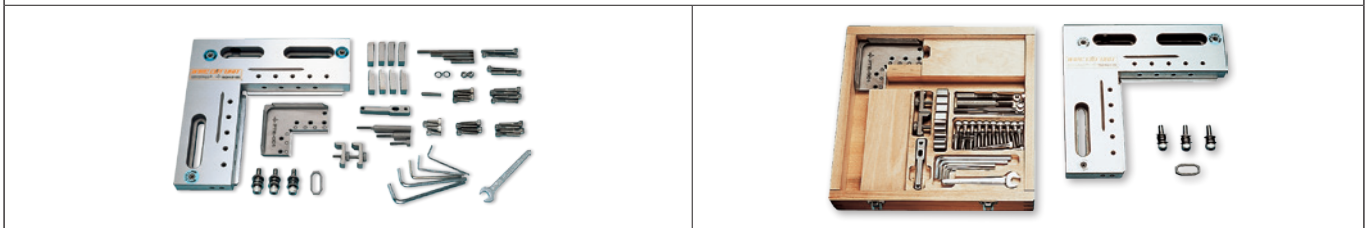

WCU - B set



WCU - C set



※The right side is the state where set contents are stored in the case.

Extension Plate (Optional accessories)

Case is not included.

PTE-001

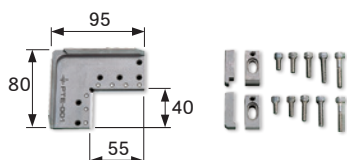

PTE-002

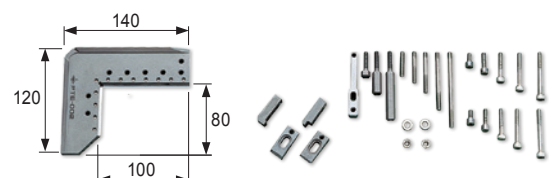

Examples of use

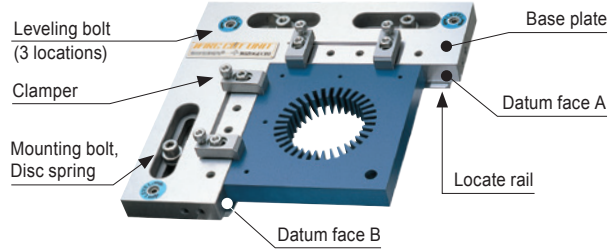
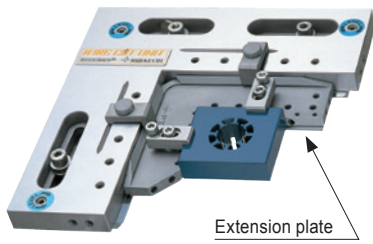

Large work-piece - Clamp on



Square work-piece - Side Clamp



Small round work-piece - Side Clamp with the extension plate

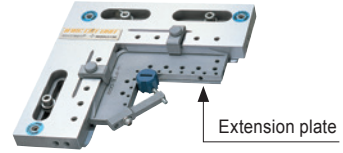

Set Contents

Name	Model No.	A set	B set	C set	Extension plate (Option)	
		WCU-A	WCU-B	WCU-C	PTE-001	PTE-002
Base plate	—	1 pc.	1 pc.	1 pc.	—	—
Extension plate (Only plate)	PTE-001	1 pc.	1 pc.	2 pcs.	1 pc.	—
	-002	—	1 pc.	2 pcs.	—	1 pc.
Clamper	CLP-101	4 pcs.	6 pcs.	10 pcs.	2 pcs.	2 pcs.
	-102	4 pcs.	6 pcs.	10 pcs.	2 pcs.	2 pcs.
	-201	1 pc.	2 pcs.	3 pcs.	—	1 pc.
Grip	GRP-002	2 pcs.	2 pcs.	2 pcs.	—	—
Adjusting bolt	AJB-M6-L (L= 30, 50, 80)	1 ea.	2 ea.	3 ea.	—	1 ea.
Stud bolt	STB-M6-L (L= 40, 50, 70, 90)	1 ea.	2 ea.	3 ea.	—	1 ea.
Cap bolt M6 × L	—	L=16, 20, 25, 30, 35 4 ea. L=40, 50 2 ea.	L=16, 20, 25, 30, 35 6 ea. L=40, 50 4 ea.	L=16, 20, 25, 30, 35 10 ea. L=40, 50 6 ea.	L=16, 20, 25, 30, 35 2 ea.	L=16, 20, 25, 30, 35, 40, 50 2 ea.
Set screw (Kultopp) M6×30	—	1 ea.	2 ea.	3 ea.	—	1 pc.
Nut, Washer M6	—	2 ea.	4 ea.	6 ea.	—	2 ea.
Hexagonal wrench, spanner	—	1 set	1 set	1 set	—	—

Specification

This unit uses stainless steel that is highly resistant to corrosion and wear.

Max. work-piece dimensions	160mm(6.30")×160mm(6.30")
Max. work-piece weight	15kg(33lbs)
Main body weight	4.3kg(9.5lbs)
Material	SUS420J2(Stainless steel)
Hardness	50HRC
Datum surface squareness	5 μm(.0002")/100mm(3.94")
	$M \perp A \cdot B$ $A \perp B$

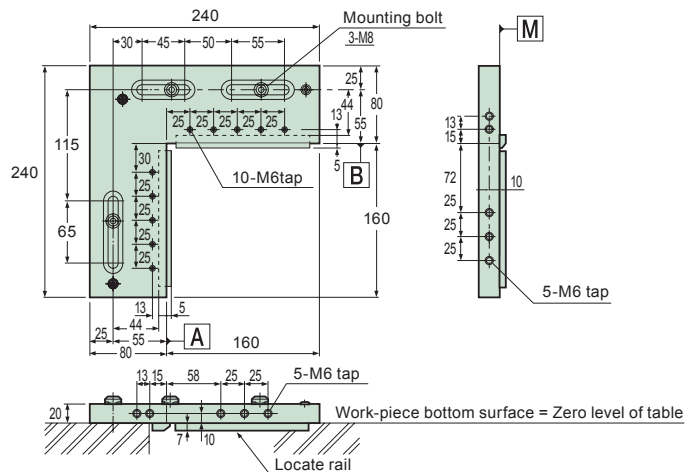

PARTS

Wrench · Spanner

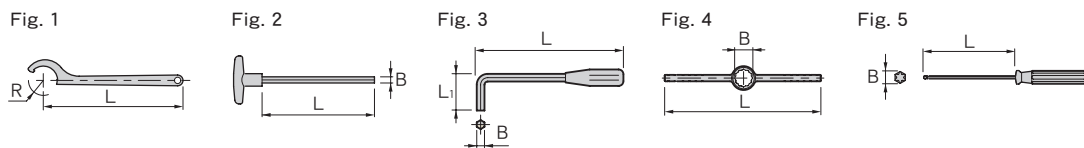

CODE	Fig.	L	R	B	L ₁	Holder type
DW-2.5-110	5	110	—	2.5	—	DTB 3
F - 22	1	110	22	—	—	DTA 3
- 38		148.5	19			DTA 7
- 45		225	22.5			DTA12
FC- 32	1	120	16	—	—	CTH10(A40, E32, E40), HUD, HUA10, AHU10, HUT4
- 36		208	18			CTA10, CTH10
- 50		281	25			CTA20, CTH20
- 55		284	27.5			CTH25(A40)
- 62		312	31			CTA25, CTH25
- 74		364	37			CTA32, CTH32
- 90		45	CTA40			
FF- 50		1	165			22.5
- 60	195		26	FMA25.4(ST42B), FMA31.75		
FM- 72	1	204	36	—	—	ART32(BT40, A50M, A63, NT40, H50)
- 82		234	41			ART32(BT50, A100, NT50)
- 97		239	48.5			ART42(BT50, A100, NT50)
RC- 26		4	240			—
TW- 4	2	77	—	4	—	DTB 7(E32)
- 5		153	—	5	—	DTB 7
- 6		173	—	6	—	DTB12
W -135	3	132.5	—	5	110	SLK12 (SLIMLINE 2PIECE TYPE)
-135 DR						DTB 7 (F63M), DTB12(E40, E50, F63M), DTE7, DTE12
-206		200		6	30	SLZ25
-308		300		8	—	SLZ32, SLZ42

Adjustable torque wrench



Spanner for torque wrench	Adjustable torque wrench	R	Holder type				
			Recommended tightening torque				
F -38AW	AW-1	19	DTA 7	D7-1.5 : 20N·m D7-2.0~7.0 : 40N·m			
-45AW		22.5	DTA12	D12(All sizes) : 70N·m			
FC-36AW	AW-1	18	CTA10 / CTH10	C10-2.6~5.0 : 40N·m C10-5.2~5.8 : 50N·m C10-6~10 : 60N·m			
-50AW				AW-2	25	CTA20 / CTH20	C20(All sizes) : 120N·m

Nozzle

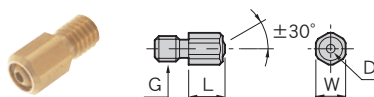

CODE	L	G	W	φD	Holder type	Q'ty
NOZ-M4-12	6.3	M4	4.5	1.2	BT40-ART	12pcs.
-60					A63 -ART -SLK	60pcs.
-M6-12	8.5	M6	7	1.8	BT50-ART	12pcs.
-60					A100-ART -SLZ	60pcs.

■Std. Access.

- Wrench for attachment

■Caution

- Four nozzles are necessary for one tool holder.

Nut (For collet holder)

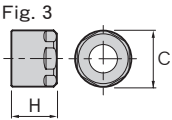
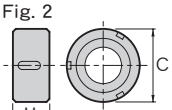
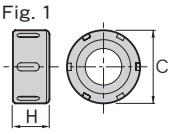

CODE	Fig.	φC	H	Holder type
NUA-CTA10	1	36	18	CTA10, AHB10
-CTA20		50	25	CTA20, AHA20, AHU20
-CTA25		62	28.5	CTA25, AHA25
-CTA32		74	32	CTA32
-CTA40		90	36	CTA40
-CTH10	2	36	18	CTH10
-CTH20		50	25	CTH20
-CTH25		62	28.5	CTH25
-CTH25-55		55		CTH25 (A40)
-CTH32		74	32	CTH32
-CTH10-32	3	32	18	CTH10 (A40, E32, E40), AHU10
-CTS10		26	21	CTS10

Sukima nut (For collet holder)

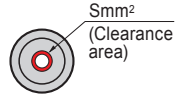
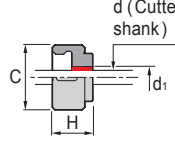

CODE	φC	H	φd	φd1	S	Holder type	
NUB-CTH10- 3.6	36	23	3	3.6	3.1	CTH10	
- 4.5			4	4.5	3.3		
- 5.5			5	5.5	3.7		
- 6.4			6	6.4	3.9		
- 8.4			8	8.4	4.6		
-10.3	50	30	6	6.4	3.9	CTH20	
-CTH20- 6.4			8	8.4	4.6		
- 8.4			10	10.3	4.8		
-10.3			12	12.3			
-12.3			16	16.2	5.1		
-16.2	62	34.5	20	20.2	5.7	CTH25	
-20.2			25	25.2	5.9		
-CTH25-20.2			74	38			CTH32
-25.2							
-CTH32-25.2			32	32.1	6.0		
-32.1							

Adjust screw

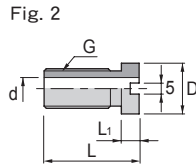
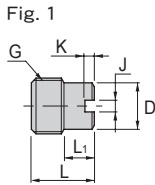

CODE	Fig.	L	φD	φd	L1	J	K	G	Holder type
AJC-M14	1	22	10	-	8	1.5	3	M14×1.5	CTA10, ST25T-CTA20, SE30M-CTA20
-M24		27	20		13	5	4	M24×1.5	CTA20(※1), BT40-CTA25-75, BT40-CTA32-105
-M28			25					M28×1.5	CTA25(※2)
-M18		24	15		8			M18×1.5	BT30-CTA20, ST32T-CTA20
-M18L	2	43	23						BT50-CTA32, CTA40, BT50-SLZ25, SLZ32, SLZ42
AJN-M18L	2	38	23	10	8	-	-	M18×1.5	BT40-ART32
-M18		63							BT50-ART32, ART42

Use this to adjust the cutter projection length.
 ※1 BT30, SE30M, ST25T and ST32T are excluded.
 ※2 BT40-CTA25-75 is excluded.

Coolant duct

Coolant duct (Fixed)

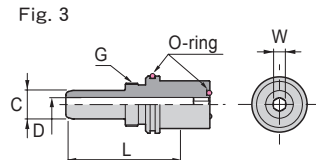
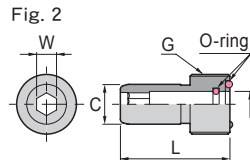
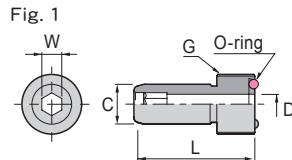

CODE	Fig.	φC	φD	L	G	W	Shank type
CD40 -01	1	8	4	29.5	M12×1	4	A40, T40
-03	3			35.5			A40-CTH10-75, A40-CTH25-95
-04				36.5			
CD50 -01	1	10	5	33	M16×1	5	A50, T50
-03	3			39			A50-CTH25-105
-04				59			
CD63 -01	1	12	6	36.5	M18×1	6	A63, T63
-02	2						A63-CTH10-75
-03	3			39.5			A63-CTH20-90
-04				60.5			A63-CTH25-105
CD100-01	1	16	8	44	M24×1.5	8	A100, T100
-02	2			10.3			A100-CTH25-135

■Note
 • Comes as a standard feature with our holders. However, for the CD50-03 and the CD63-03, CD50-04 and CD63-04 come as options, respectively.

Coolant duct (Adjustable)

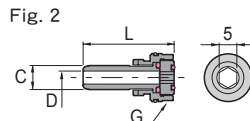
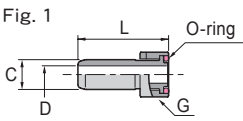

CODE	Fig.	φC	L	φD	G	Replaceable coolant duct
CD63 -01F	1	12	36.5	7	M18×1	CD 63-01
-03F	2		45.5	6.5		CD 63-03
CD100-01F	1	16	44	10	M24×1.5	CD100-01

■Note
 • For some machines, the use of a coolant duct (Adjustable) is recommended. The existing coolant duct is replaced with an adjustable one at your request only when you have placed an order for the holder.
 • If the replacement of the coolant duct is needed after the purchase, use the wrench CD63-01F-RNT.

Dummy duct

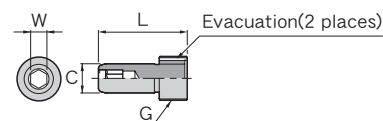

CODE	φC	L	G	W	Replaceable coolant duct
CD40 -A1	8	29.5	M12×1	4	CD 40-01
CD50 -A1	10	33	M16×1	5	CD 50-01
CD63 -A1	12	36.5	M18×1	6	CD 63-01
CD100-A1	16	44	M24×1.5	8	CD100-01

ANGLE HEAD HALF PARTS LIST

HFD7 / HFT4 (BT30/40/50, A63, DN40/50, CT40/50)

CODE (Master holder)	1 Shank	2 Orientation Ring	8 Washer for intermediate bearing B	9 Intermediate bearing	19 Head
BT30 -HFD7-122	BT30 -FSA-7S	ORR-30	-	-	FBA-7S
-HFT4-122	BT30 -FSA-7L				FZ-7
-HFD7-182	BT30 -FSA-7S	ORR-40	-	-	FBA-7S
-HFT4-182					BT30 -FSA-7L
BT40 -HFD7-120	BT40 -FSA-7S	ORR-40	-	-	FBA-7S
-HFT4-120	BT40 -FSA-7L				FZ-7
-HFD7-180	BT40 -FSA-7S	ORR-40	-	-	FBA-7S
-HFT4-180					BT40 -FSA-7L
BT50 -HFD7-195	BT50 -FSA-7L	ORR-40	-	-	FBA-7L
-HFT4-195	BT50 -FSA-7XL				FBA-7XL
-HFD7-255	BT50 -FSA-7S	ORR-40	-	-	FBA-7S
-HFT4-255					BT50 -FSA-7L
A63 -HFD7-183	A63 -FSA-7L	ORR-40	-	-	FBA-7L
-HFT4-183	A63 -FSA-7XL				FBA-7XL
-HFD7-243	A63 -FSA-7S	ORR-40	-	-	FBA-7S
-HFT4-243					A63 -FSA-7L
DN40A-HFD7-135	DN40A-FSA-7S	ORR-40	-	-	FBA-7S
-HFT4-135	DN40A-FSA-7L				FZ-7
-HFD7-195	DN40A-FSA-7S	ORR-40	-	-	FBA-7S
-HFT4-195					DN40A-FSA-7L
DN50A-HFD7-195	DN50A-FSA-7L	ORR-40	-	-	FBA-7L
-HFT4-195	DN50A-FSA-7XL				FBA-7XL
-HFD7-255	DN50A-FSA-7S	ORR-40	-	-	FBA-7S
-HFT4-255					DN50A-FSA-7L
CT40 -HFD7-135	CT40 -FSA-7S	ORR-40	-	-	FBA-7S
-HFT4-135	CT40 -FSA-7L				FZ-7
-HFD7-195	CT40 -FSA-7S	ORR-40	-	-	FBA-7S
-HFT4-195					CT40 -FSA-7L
CT50 -HFD7-195	CT50 -FSA-7L	ORR-40	-	-	FBA-7L
-HFT4-195	CT50 -FSA-7XL				FBA-7XL
-HFD7-255	CT50 -FSA-7S	ORR-40	-	-	FBA-7S
-HFT4-255					CT50 -FSA-7L

Std. Access.

- Fixing spanner (KS-23) • Hexagonal wrench set (W-1550S)
- Single-ended wrench 13mm (SN-13)

※ 3, 9, 11, 14 and 22 are able to use standard commercial items.

The tools for assembly

Wrench (for shank)

To be used for tightening 11.

CODE	Image
FC-32	

Wrench (for head)

To be used for tightening 12 and 13.

CODE	Image
TSH-HF7	

HFD7

Drill
(φ1~7)

DETa-1 Collet
(D7)→P.8

HFT4

Tap sleeve
(TA4)→P.8

Tap
(M2~8)

23 Angle shaft (for drilling)
CODE FR-D7L

26 Draw bolt
CODE FR-7BL

21 Collar C
CODE FBC-7C

25 Draw nut and spring
CODE FR-T4NS

22 Bearing for angle shaft
CODE 71804

24 Angle shaft (for tapping)
CODE FR-T4

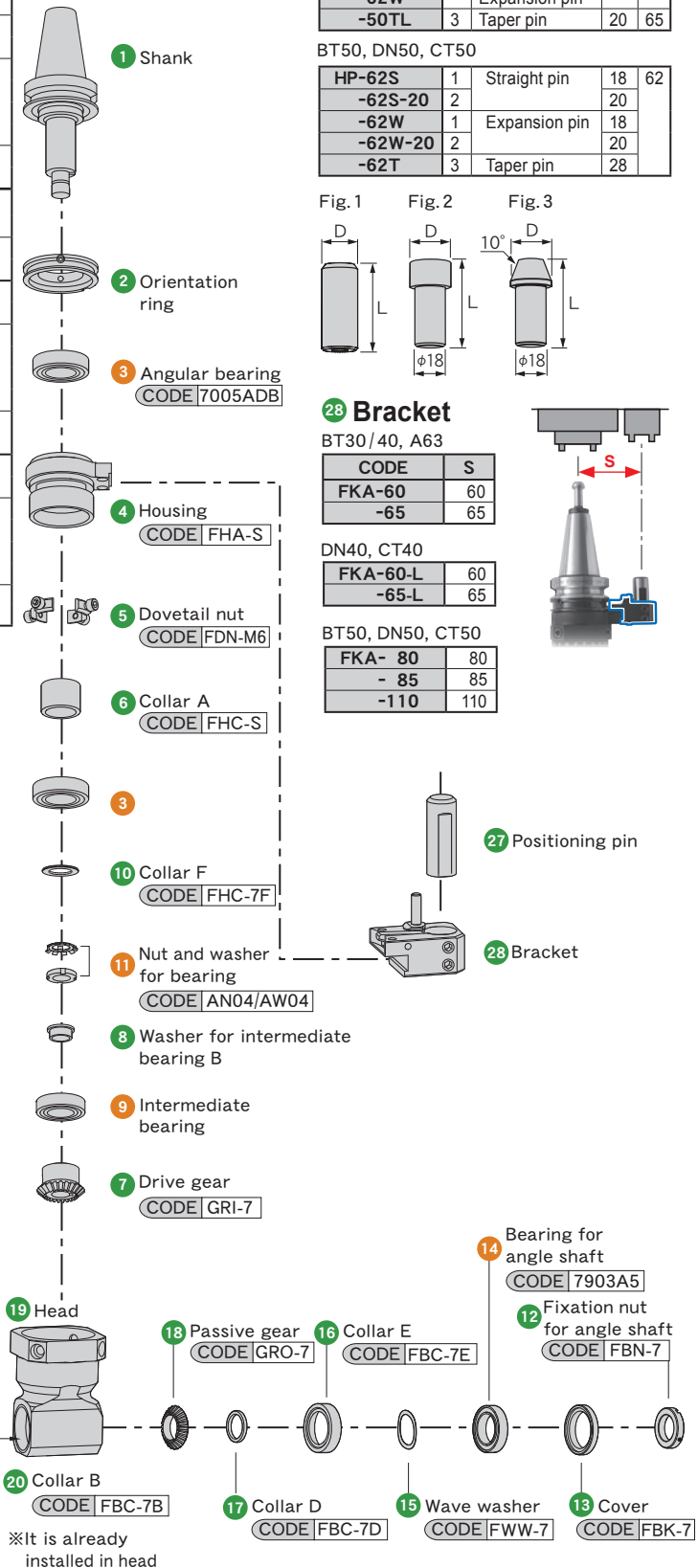

27 Positioning pin

BT30/40, A63

CODE	Fig.	Pin type	φD	L
HP-50S	1	Straight pin	18	50
-50W		Expansion pin		
-50T	3	Taper pin	20	

DN40, CT40

CODE	Fig.	Pin type	φD	L
HP-62S	1	Straight pin	18	62
-62W		Expansion pin		
-62TL	3	Taper pin	20	65

BT50, DN50, CT50

CODE	Fig.	Pin type	φD	L
HP-62S	1	Straight pin	18	62
-62S-20	2		20	
-62W	1	Expansion pin	18	
-62W-20	2		20	
-62T	3	Taper pin	28	

Fig. 1

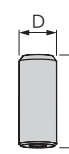

Fig. 2

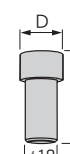
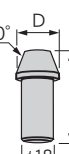

Fig. 3



28 Bracket

BT30/40, A63

CODE	S
FKA-60	60
-65	65

DN40, CT40

CODE	S
FKA-60-L	60
-65-L	65

BT50, DN50, CT50

CODE	S
FKA-80	80
-85	85
-110	110

HFD7L / HFA10 / HFT4L (BT30)

CODE (Master Holder)
BT30-HFD7L-120
-HFA10-120
-HFT4L-120

Std. Access.

- Fixing spanner (KS-23) (HFD7L)
- Hexagonal wrench set (W-1550S)
- Single-ended wrench (SN-13) (HFD7L/HFA10)
- Fook spanner (FC-32) (HFA10)

※ 3, 4, 9, 15 and 16 are able to use standard commercial items.

28 Positioning pin

CODE	Pin type	φD	L
HP-45S	Straight pin	12	45
HP-E50S	Straight pin	18	50

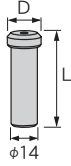

29 Bracket

CODE	S
FKC-50	50
FKC-65	65

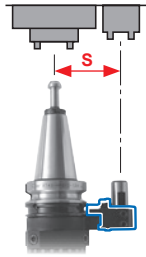

Note

- Be sure to use positioning pin (HP-45S) and the bracket (FKC-50) in a combination, and the positioning pin (HP-E50S) and the bracket (FKC-65) in combination.

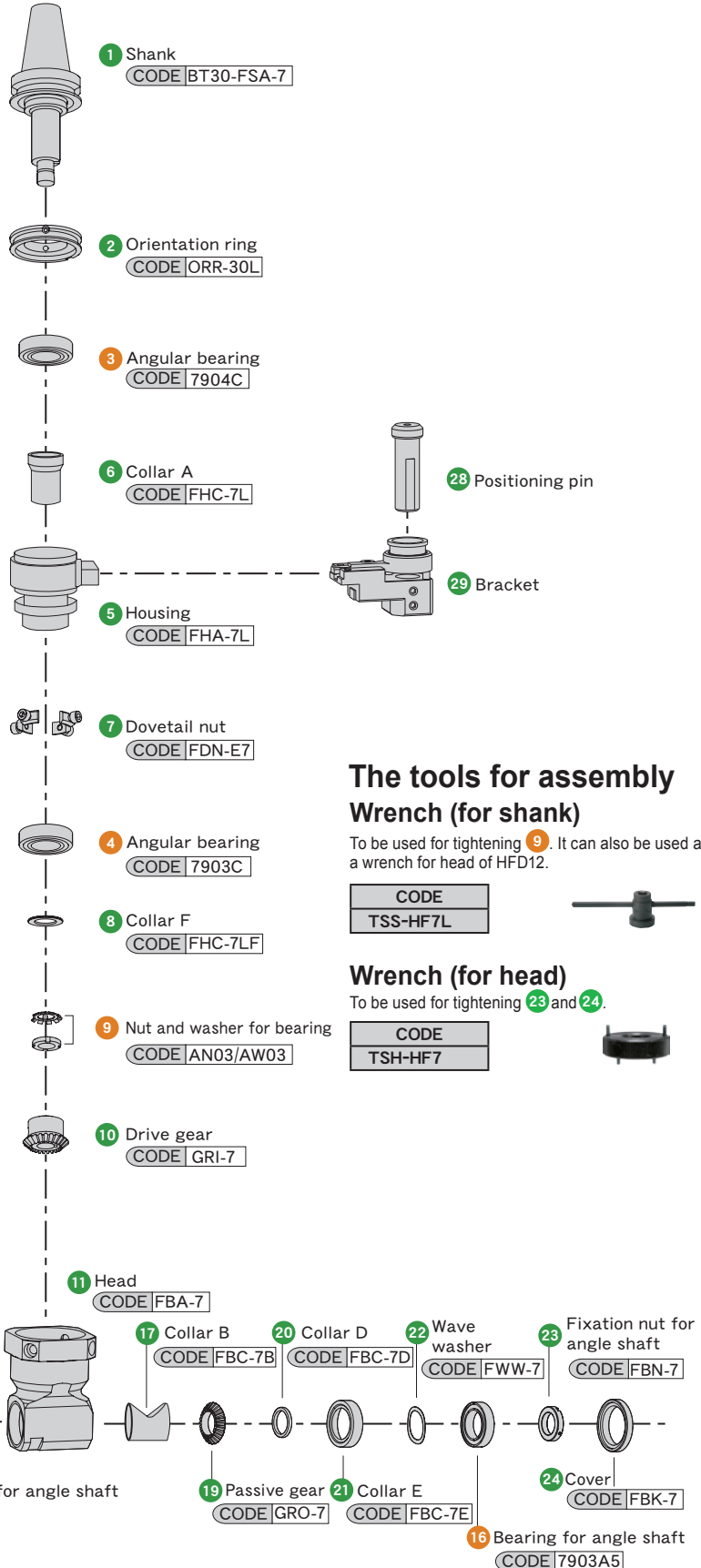

The tools for assembly
Wrench (for shank)

To be used for tightening 9. It can also be used as a wrench for head of HFD12.

CODE
TSS-HF7L



Wrench (for head)

To be used for tightening 23 and 24.

CODE
TSH-HF7



HFD7L

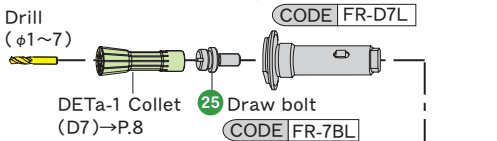

HFA10

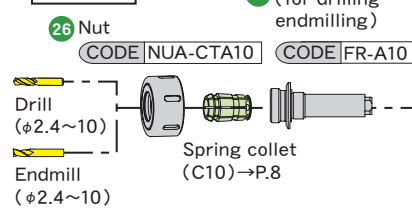

HFT4L

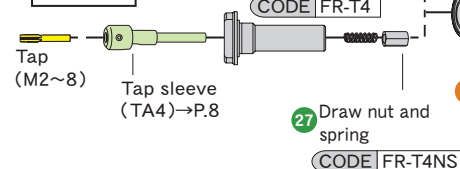

HFD12 / HFT6 (BT30/40/50, A63, DN40/50, CT40/50)

CODE (Master Holder)	1 Shank	2 Orientation Ring	3 Angular bearing	4 Housing	6 Collar A	7 Collar AXL	8 Intermediate bearing	
BT30 -HFD12-122 -HFT 6-122	BT30 -FSA-12S	ORR-30	7005ADB	FHA-S	FHC-S	-	-	
BT40 -HFD12-120 -HFT 6-120	BT40 -FSA-12S	ORR-40		FHA-L	FHC-L	-	-	
-HFD12-180 -HFT 6-180	BT40 -FSA-12L			FHA-S	FHC-S	-	-	
BT50 -HFD12-135 -HFT 6-135	BT50 -FSA-12S			FHA-L	FHC-L	-	-	
-HFD12-195 -HFT 6-195	BT50 -FSA-12L			7906A5DB	FHA-XL	FHC-XL1 (※)	FHC-XL2 (※)	6005VV
-HFD12-255 -HFT 6-255	BT50 -FSA-12XL							
A63 -HFD12-123 -HFT 6-123	A63 -FSA-12S	ORR-40	7005ADB	FHA-S	FHC-S	-	-	
-HFD12-183 -HFT 6-183	A63 -FSA-12L			FHA-L	FHC-L	-	-	
-HFD12-243 -HFT 6-243	A63 -FSA-12XL			7906A5DB	FHA-XL	FHC-XL1 (※)	FHC-XL2 (※)	6005VV
DN40A-HFD12-135 -HFT 6-135	DN40A-FSA-12S	ORR-40	7005ADB	FHA-S	FHC-S	-	-	
-HFD12-195 -HFT 6-195	DN40A-FSA-12L			FHA-L	FHC-L	-	-	
DN50A-HFD12-135 -HFT 6-135	DN50A-FSA-12S			FHA-S	FHC-S	-	-	
-HFD12-195 -HFT 6-195	DN50A-FSA-12L		FHA-L	FHC-L	-	-		
-HFD12-255 -HFT 6-255	DN50A-FSA-12XL		7906A5DB	FHA-XL	FHC-XL1 (※)	FHC-XL2 (※)	6005VV	
CT40 -HFD12-135 -HFT 6-135	CT40 -FSA-12S	ORR-40	7005ADB	FHA-S	FHC-S	-	-	
-HFD12-195 -HFT 6-195	CT40 -FSA-12L			FHA-L	FHC-L	-	-	
CT50 -HFD12-135 -HFT 6-135	CT50 -FSA-12S			FHA-S	FHC-S	-	-	
-HFD12-195 -HFT 6-195	CT50 -FSA-12L		FHA-L	FHC-L	-	-		
-HFD12-255 -HFT 6-255	CT50 -FSA-12XL		7906A5DB	FHA-XL	FHC-XL1 (※)	FHC-XL2 (※)	6005VV	

(※) FHC-XL1/XL2 FHC-XL1/XL2 Set 2pcs-each

■ Std. Access.

- Fixing spanner (KS-30) ● Hexagonal wrench set (W-1550S)
- Single-ended wrench 17mm (SN-17)

※ 3, 8, 10, 13 and 16 are able to use standard commercial items.

The tools for assembly

Wrench (for shank)

To be used for tightening 10.



Wrench (for head)

To be used for tightening 11 and 12.

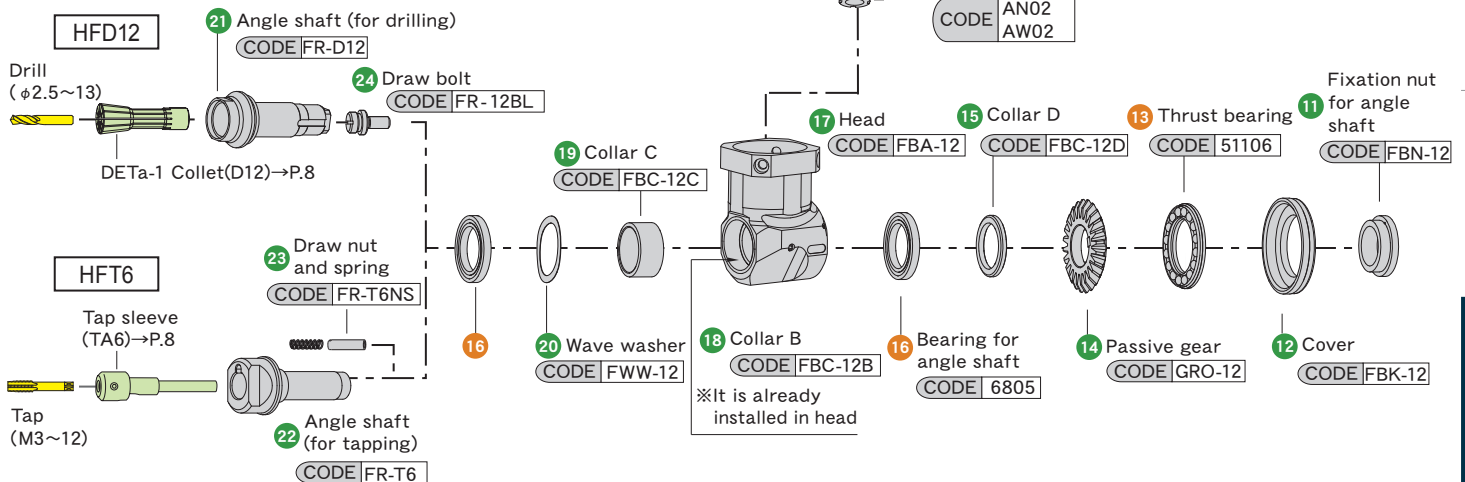

25 Positioning pin

BT30/40, A63

CODE	Fig.	Pin type	φD	L
HP-50S	1	Straight pin	18	50
-50W		Expansion pin		
-50T	3	Taper pin	20	

DN40, CT40

CODE	Fig.	Pin type	φD	L
HP-62S	1	Straight pin	18	62
-62W		Expansion pin		
-62TL	3	Taper pin	20	65

BT50, DN50, CT50

CODE	Fig.	Pin type	φD	L
HP-62S	1	Straight pin	18	62
-62S-20	2		20	
-62W	1	Expansion pin	18	
-62W-20	2		20	
-62T	3	Taper pin	28	

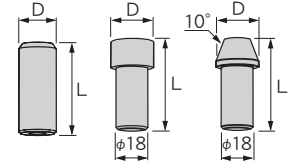

26 Bracket

BT30/40, A63

CODE	S
FKA-60	60
-65	65

DN40, CT40

CODE	S
FKA-60-L	60
-65-L	65

BT50, DN50, CT50

CODE	S
FKA-80	80
-85	85
-110	110

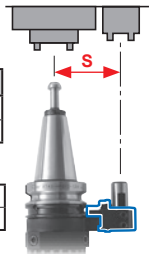

HFA20 / HFT12 (BT40/50, A63, DN40/50, CT40/50)

CODE (Master Holder)	1 Shank	3 Needle bearing	5 Angular bearing	6 Collar A	7 Housing	8 Angular bearing
BT40 -HFA20-135	BT40 -FSA-20S	—	7906A5	FHC-20S	FHA-20S	7905A5
-HFT12-135				FHC-20L	FHA-20L	
-HFA20-195	BT40 -FSA-20L			FHC-20S	FHA-20S	
-HFT12-195				FHC-20L	FHA-20L	
BT50 -HFA20-150	BT50 -FSA-20S			FHC-20S	FHA-20S	
-HFT12-150				FHC-20L	FHA-20L	
-HFA20-210	BT50 -FSA-20L			FHC-20S	FHA-20S	
-HFT12-210				FHC-20L	FHA-20L	
-HFA20-270	BT50 -FSA-20XL	TAF374720	7905A5DB	FHC-20XL	FHA-20XL	—
-HFT12-270						
A63 -HFA20-198	A63 -FSA-20L	—	7906A5	FHC-20L	FHA-20L	7905A5
-HFT12-198				FHC-20S	FHA-20S	
-HFA20-258	A63 -FSA-20XL	TAF374720	7905A5DB	FHC-20XL	FHA-20XL	—
-HFT12-258						
DN40A-HFA20-150	DN40A-FSA-20S	—	7906A5	FHC-20S	FHA-20S	7905A5
-HFT12-150				FHC-20L	FHA-20L	
-HFA20-210	DN40A-FSA-20L			FHC-20S	FHA-20S	
-HFT12-210				FHC-20L	FHA-20L	
DN50A-HFA20-150	DN50A-FSA-20S			FHC-20S	FHA-20S	
-HFT12-150				FHC-20L	FHA-20L	
-HFA20-210	DN50A-FSA-20L			FHC-20S	FHA-20S	
-HFT12-210				FHC-20L	FHA-20L	
-HFA20-270	DN50A-FSA-20XL	TAF374720	7905A5DB	FHC-20XL	FHA-20XL	—
-HFT12-270						
CT40 -HFA20-150	CT40 -FSA-20S	—	7906A5	FHC-20S	FHA-20S	7905A5
-HFT12-150				FHC-20L	FHA-20L	
-HFA20-210	CT40 -FSA-20L			FHC-20S	FHA-20S	
-HFT12-210				FHC-20L	FHA-20L	
CT50 -HFA20-150	CT50 -FSA-20S			FHC-20S	FHA-20S	
-HFT12-150				FHC-20L	FHA-20L	
-HFA20-210	CT50 -FSA-20L			FHC-20S	FHA-20S	
-HFT12-210				FHC-20L	FHA-20L	
-HFA20-270	CT50 -FSA-20XL	TAF374720	7905A5DB	FHC-20XL	FHA-20XL	—
-HFT12-270						

Std. Access.

- Fixing spanner (KS-41) • Hexagonal wrench set (W-1550S)
- Fook spanner (FC-50) (HFA20)

※ 3, 5, 8, 16, 18 and 21 are able to use standard commercial items.

The tools for assembly

Wrench (for shank and head)

To be used for tightening 11 and 17.

CODE
TS-HA20



Assembling tool for needle bearings

To be used for tightening 21.

CODE
TPN-HA20



HFA20

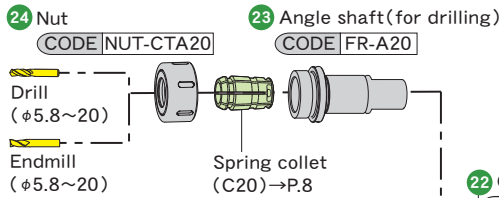

HFT12

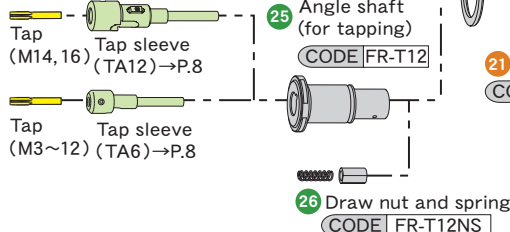

27 Positioning pin

BT40, A63

CODE	Fig.	Pin type	φD	L
HP-50S	1	Straight pin	18	50
-50W		Expansion pin		
-50T	3	Taper pin	20	

DN40, CT40

CODE	Fig.	Pin type	φD	L
HP-62S	1	Straight pin	18	62
-62W		Expansion pin		
-50TL	3	Taper pin	20	65

BT50, DN50, CT50

CODE	Fig.	Pin type	φD	L
HP-62S	1	Straight pin	18	62
-62S-20	2		20	
-62W	1	Expansion pin	18	
-62W-20	2		20	
-62T	3	Taper pin	28	

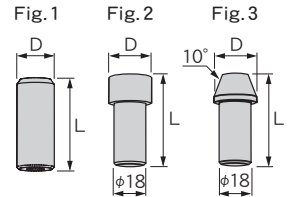

28 Bracket

BT40, A63, DN40, CT40

CODE	S
FKB-60	60
-65	65

BT50, DN50, CT50

FKB-	S
80	80
- 85	85
-110	110

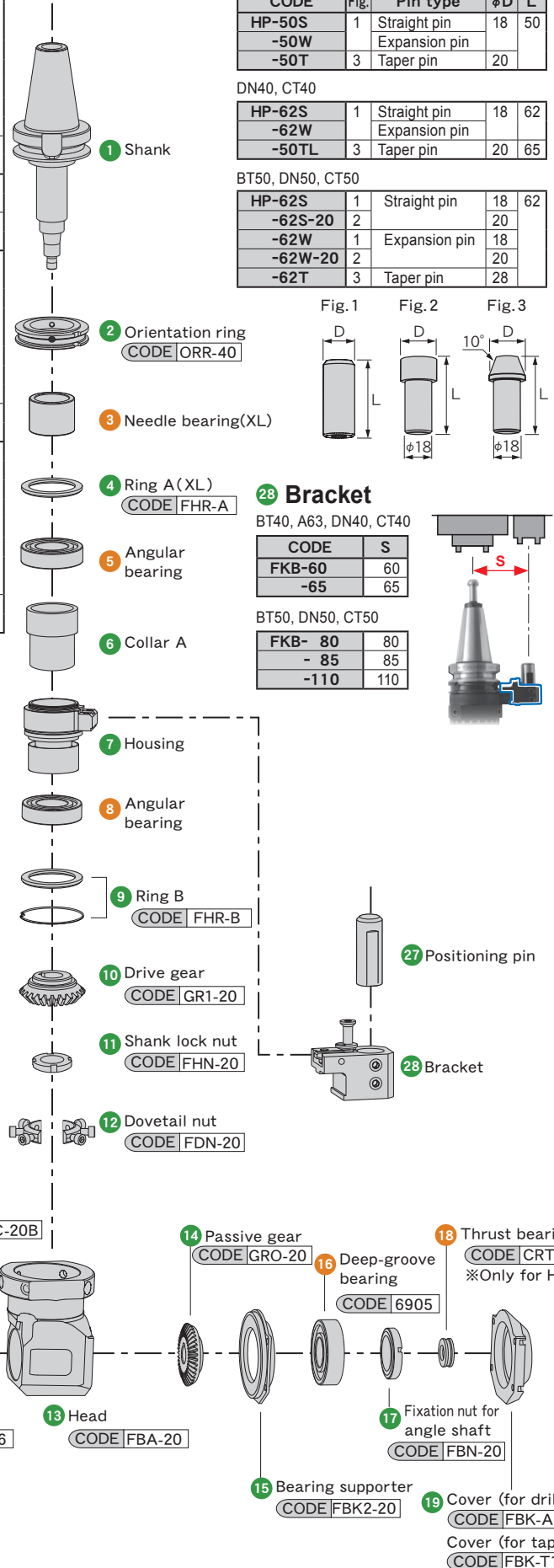
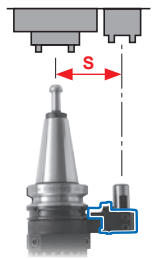

HFCS6 (BT30)

CODE(Master Holder)
BT30-HFCS6-155

Std. Access.

- Fixing spanner(PS-21)
- Hexagonal wrench set (W-1550S)
- ※ 3, 7, 9, 14, 15 and 20 are able to use standard commercial items.

The tools for assembly

Wrench (for shank)

To be used for tightening 9.
It can also be used as a wrench for head of HFD12.

CODE
TSH-HF12



Pliers for Retaining ring

To be used for tightening 28.

CODE
TSH-G6



29 Positioning pin

CODE	Pin type	φD	L
HP-45S	Straight pin	12	45
HP-E50S	Straight pin	18	50

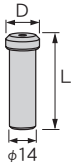

30 Bracket

CODE	S
FKC-50	50
FKC-65	65

Note

- Be sure to use positioning pin (HP-45S) and the bracket (FKC-50) in a combination, and the positioning pin (HP-E50S) and the bracket (FKC-65) in combination.

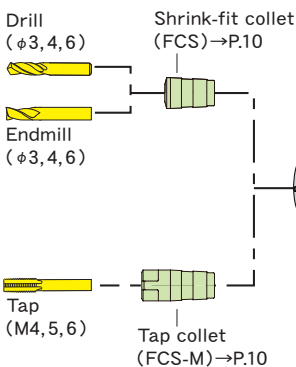
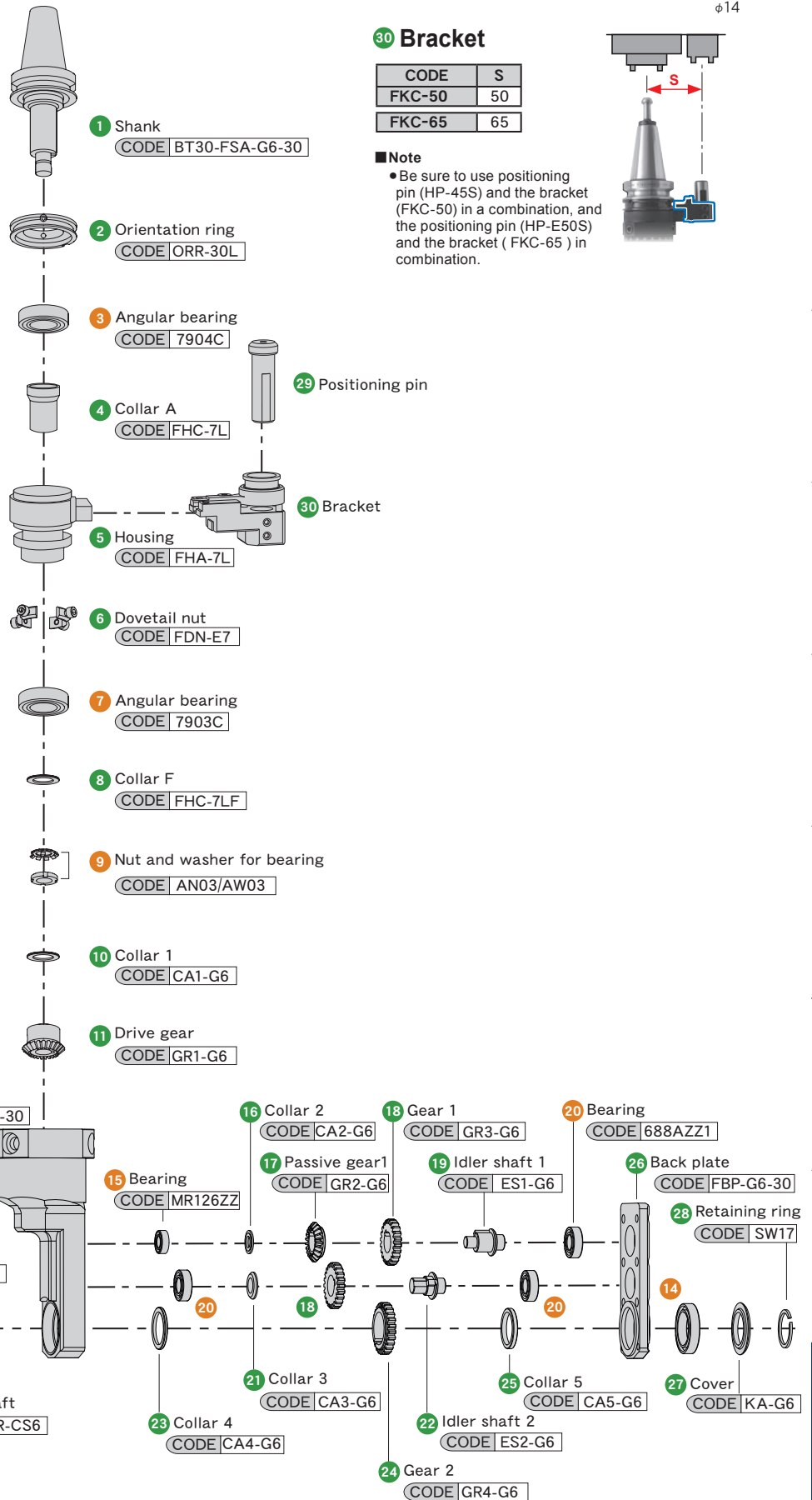
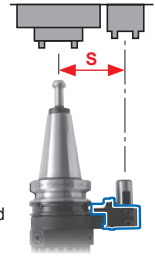

HFCS6 (BT40/50, DN40/50, CT40/50)

CODE (Master Holder)	1 Shank		11 Head		17 Gear 1		18 Gear 3		20 Bearing		21 Collar 3		22 Idler shaft 2		26 Back plate	
					Q'ty		Q'ty		Q'ty		Q'ty	Q'ty		Q'ty		
BT40 -HFCS6-160 -205	BT40	-FSA-G6	FBA-G6	GR3-G6	2	—	688AZZ1	3	CA3-G6	1	ES2-G6	1	FGP-G6			
			FBA-G6L	3	GR5-G6	7								3	3	3
BT50 -HFCS6-175 -220	BT50	-FSA-G6	FBA-G6	GR3-G6	2	—	688AZZ1	3	CA3-G6	1	ES2-G6	1	FGP-G6			
			FBA-G6L		3	GR5-G6								7	3	3
DN40A-HFCS6-175 -220	DN40A	-FSA-G6	FBA-G6	GR3-G6	2	—	688AZZ1	3	CA3-G6	1	ES2-G6	1	FGP-G6			
			FBA-G6L		3	GR5-G6								7	3	3
DN50A-HFCS6-175 -220	DN50A	-FSA-G6	FBA-G6	GR3-G6	2	—	688AZZ1	3	CA3-G6	1	ES2-G6	1	FGP-G6			
			FBA-G6L		3	GR5-G6								7	3	3
CT40 -HFCS6-175 -220	CT40	-FSA-G6	FBA-G6	GR3-G6	2	—	688AZZ1	3	CA3-G6	1	ES2-G6	1	FGP-G6			
			FBA-G6L		3	GR5-G6								7	3	3
CT50 -HFCS6-175 -220	CT50	-FSA-G6	FBA-G6	GR3-G6	2	—	688AZZ1	3	CA3-G6	1	ES2-G6	1	FGP-G6			
			FBA-G6L		3	GR5-G6								7	3	3

■ Std. Access.

- Fixing spanner (PS-21)
- Hexagonal wrench set (W-1550S)

※ 3, 8, 13, 14 and 20 are able to use standard commercial items.

29 Positioning pin

BT40				
CODE	Fig.	Pin type	φD	L
HP-50S	1	Straight pin	18	50
-50W		Expansion pin		
-50T	3	Taper pin	20	

DN40, CT40				
CODE	Fig.	Pin type	φD	L
HP-62S	1	Straight pin	18	62
-62W		Expansion pin		
-62TL	3	Taper pin	20	65

BT50, DN50, CT50				
CODE	Fig.	Pin type	φD	L
HP-62S	1	Straight pin	18	62
-62S-20	2		20	
-62W	1	Expansion pin	18	
-62W-20	2		20	
-62T	3	Taper pin	28	

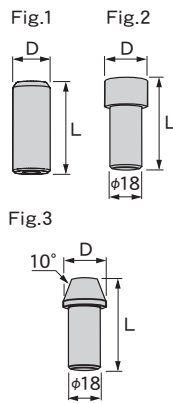

30 Bracket

BT40		
CODE	S	
FKA-60	60	
-65	65	

DN40, CT40		
CODE	S	
FKA-60-L	60	
-65-L	65	

BT50, DN50, CT50		
CODE	S	
FKA-80	80	
-85	85	
-110	110	

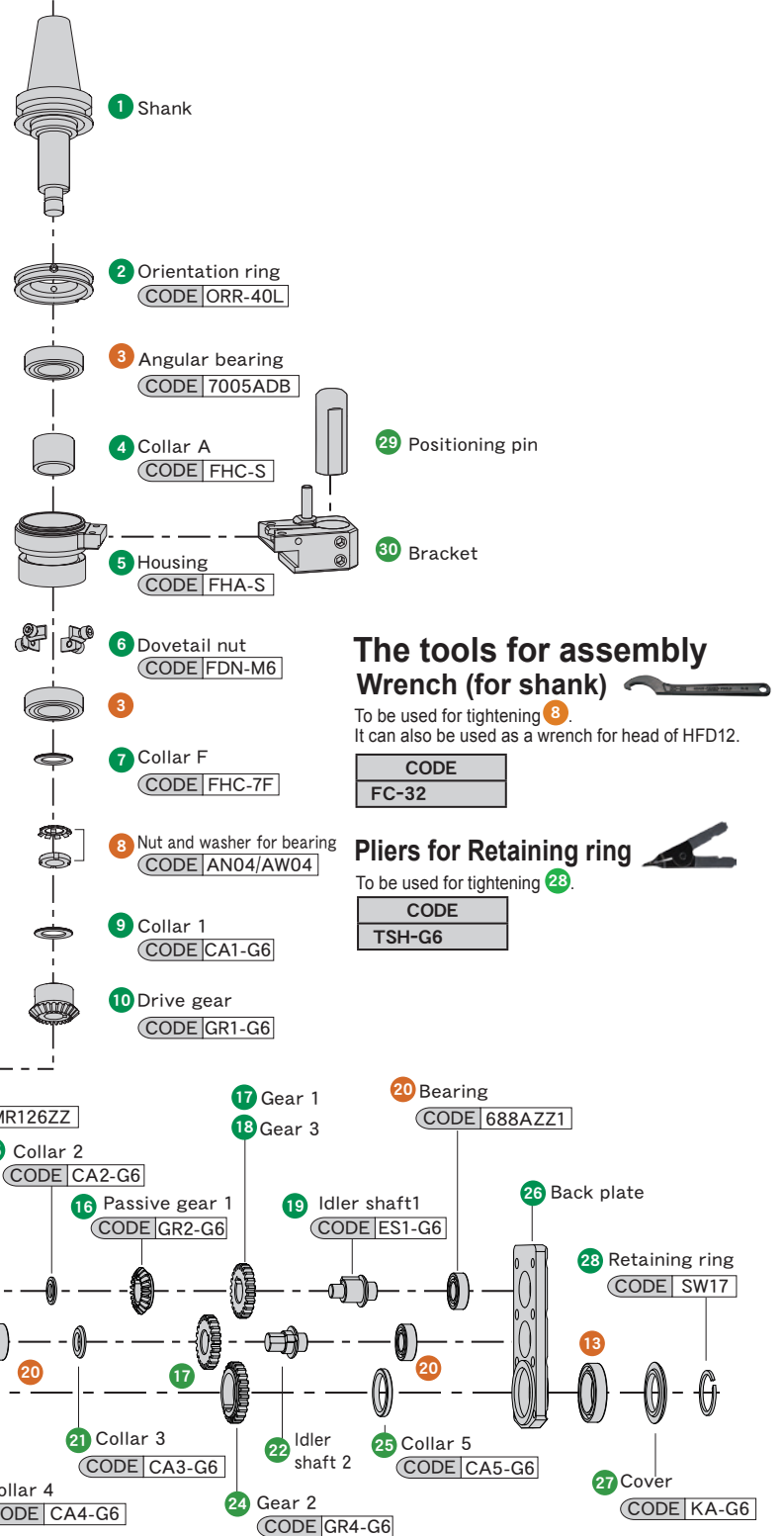
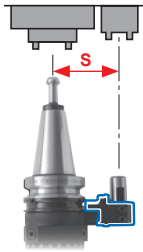

The tools for assembly Wrench (for shank)

To be used for tightening 8. It can also be used as a wrench for head of HFD12.

CODE
FC-32

Pliers for Retaining ring

To be used for tightening 28.

CODE
TSH-G6

- Drill (φ3, 4, 6)
- Shrink-fit collet (FCS) → P.10
- Endmill (φ3, 4, 6)
- Angle shaft (CODE FR-CS6) ※ With a draw bolt
- Tap (M4, 5, 6)
- Tap collet (FCS-M) → P.10

HUD7 / HUA10 / HUT4 (BT40/50, DN40/50, CT40/50)

CODE (Master Holder)	① Shank
BT40 -HUD 7-135 -HUA10-135 -HUT 4-135	BT40-FSA-U7
BT50 -HUD 7-150 -HUA10-150 -HUT 4-150	BT50-FSA-U7
DN40A-HUD 7-150 -HUA10-150 -HUT 4-150	DN40A-FSA-U7
DN50A-HUD 7-150 -HUA10-150 -HUT 4-150	DN50A-FSA-U7
CT40 -HUD 7-150 -HUA10-150 -HUT 4-150	CT40-FSA-U7
CT50 -HUD 7-150 -HUA10-150 -HUT 4-150	CT50-FSA-U7

Std. Access.

- Fixing spanner(KS-21)
- Hexagonal wrench set (W-1550S)
- Fook spanner(FC-32) (HUA10)

※ ③, ⑧, ⑬, ⑯, ⑳ and ㉓ are able to use standard commercial items.

The tools for assembly Wrench (for shank)

CODE	To be used for tightening ⑧.
FC-32	

Wrench (for head) · Assembling tool for needle bearings

To be used for tightening ⑯, ㉒ and ㉓.

CODE	
TP-U7	

HUD7

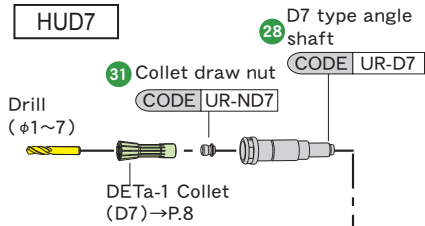

HUA10

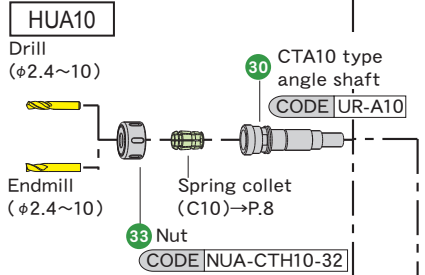

HUT4

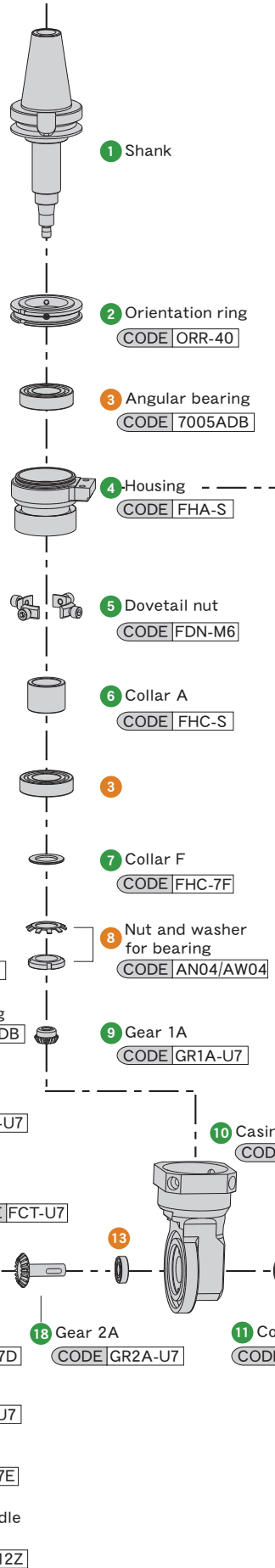
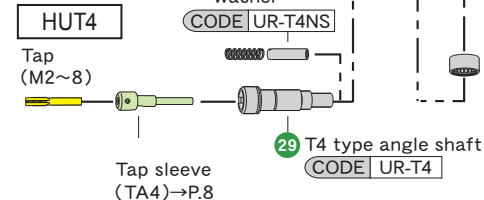

③④ Positioning pin

BT40

CODE	Fig.	Pin type	φD	L
HP-50S	1	Straight pin	18	50
-50W		Expansion pin		
-50T	3	Taper pin	20	

DN40, CT40

CODE	Fig.	Pin type	φD	L
HP-62S	1	Straight pin	18	62
-62W		Expansion pin		
-62TL	3	Taper pin	20	65

BT50, DN50, CT50

CODE	Fig.	Pin type	φD	L
HP-62S	1	Straight pin	18	62
-62S-20	2		20	
-62W	1	Expansion pin	18	
-62W-20	2		20	
-62T	3	Taper pin	28	

Fig. 1



Fig. 2



Fig. 3

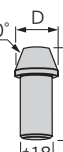

③⑤ Bracket

BT40

CODE	S
FKA-60	60
-65	65

DN40, CT40

CODE	S
FKA-60-L	60
-65-L	65

BT50, DN50, CT50

CODE	S
FKA- 80	80
- 85	85
-110	110

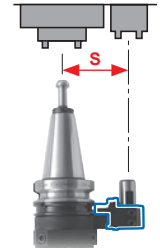

HUA20 / HUT6 (BT40/50, DN40/50, CT40/50)

CODE (Master Holder)	① Shank
BT40 -HUA20-135 -HUT 6-135	BT40 -FSA-U20
BT50 -HUA20-150 -HUT 6-150	BT50 -FSA-U20
DN40A-HUA20-150 -HUT 6-150	DN40A- FSA-U20
DN50A-HUA20-150 -HUT 6-150	DN50A- FSA-U20
CT40 -HUA20-150 -HUT 6-150	CT40 -FSA-U20
CT50 -HUA20-150 -HUT 6-150	CT50 -FSA-U20

■ Std. Access.

- Fixing spanner (KS-33)
- Hexagonal wrench set (W-1560S)
- Fook spanner (FC-50) (HUA20)

※ ③, ⑦, ⑩, ⑭, ⑰, ⑳, ㉓ and ㉔ are able to use standard commercial items.

③⑤ Positioning pin

BT40

CODE	Fig.	Pin type	φD	L
HP-50S	1	Straight pin	18	50
-50W		Expansion pin		
-50T	3	Taper pin	20	

DN40, CT40

CODE	Fig.	Pin type	φD	L
HP-62S	1	Straight pin	18	62
-62W		Expansion pin		
-50TL	3	Taper pin	20	65

BT50, DN50, CT50

CODE	Fig.	Pin type	φD	L
HP-62S	1	Straight pin	18	62
-62S-20	2		20	
-62W	1	Expansion pin	18	
-62W-20	2		20	
-62T	3	Taper pin	28	

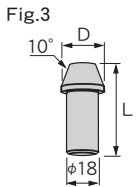
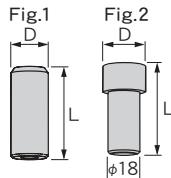

③⑥ Bracket

BT40, DN40, CT40

CODE	S
FKB-60	60
-65	65

BT50, DN50, CT50

FKB-	S
80	80
- 85	85
-110	110

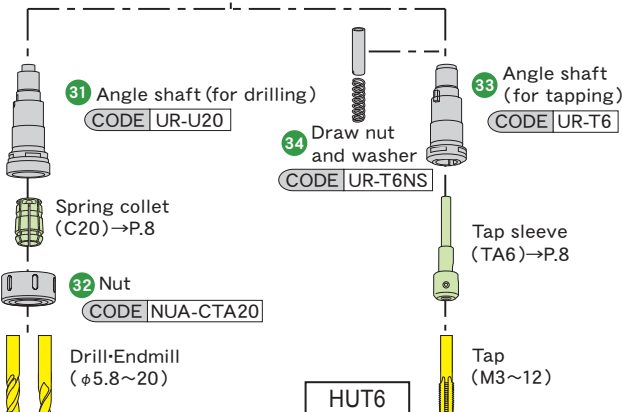
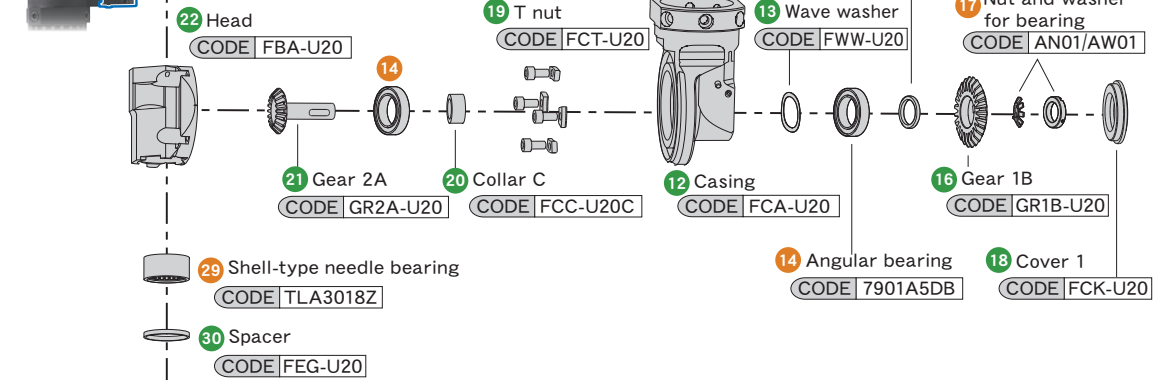
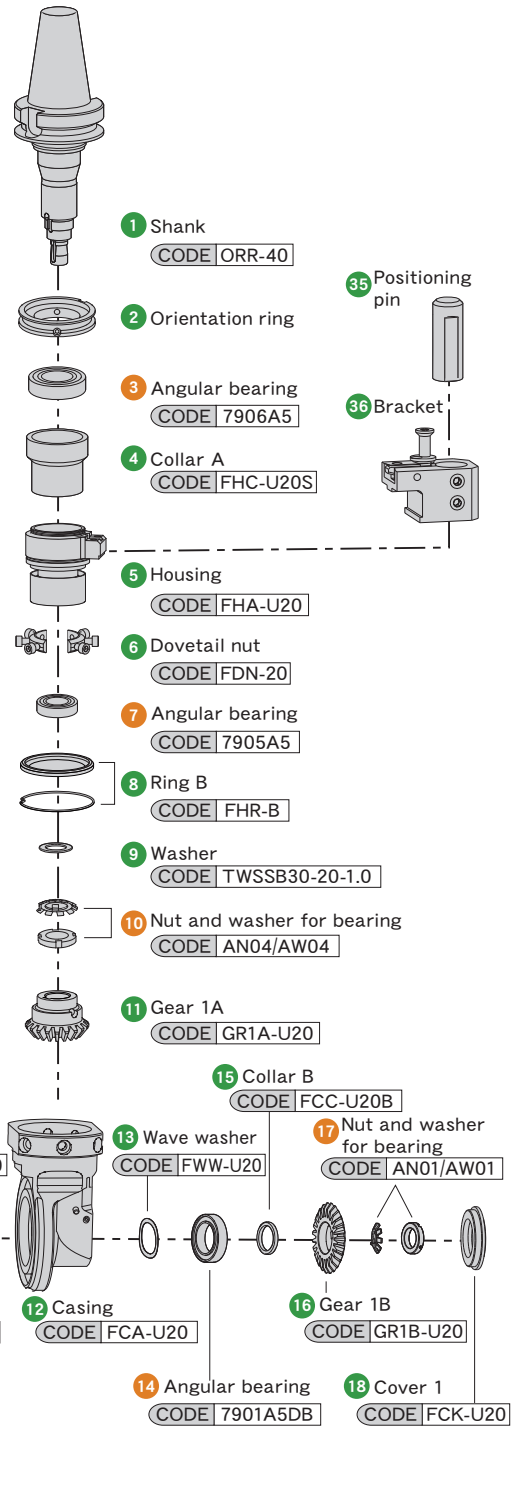
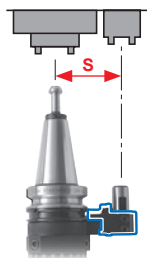

The tools for assembly

Wrench (for shank) **Wrench (for head)**

To be used for tightening ⑩ and ⑰. To be used for tightening ㉔.

CODE TSS-HU20		CODE TSH-HF12	
------------------	--	------------------	--

Assembling tool for needle bearings

To be used for tightening ㉔.

CODE TPN-HU20	
------------------	--

Technical support

At MST, we provide the long-term support that allows you to use our products safely and to maintain the high accuracy of our products for your machining.

1. Pre-sales

Provide wide-ranging technical support.



Tool selection

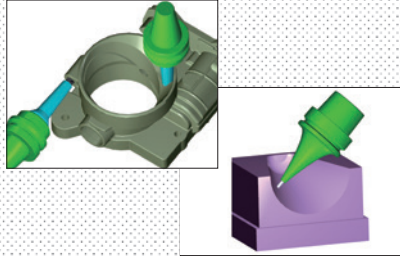

Interference check with 3D drawings

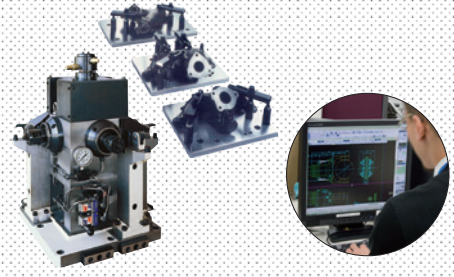

Designing manufacturing jig fixtures

2. On delivery

You will receive instructions.



Instructions for a heater



Maintenance instruction

3. Post-sales

Our Tool Clinic experts can visit your factory to demonstrate the correct usage, maintenance and give seminars.

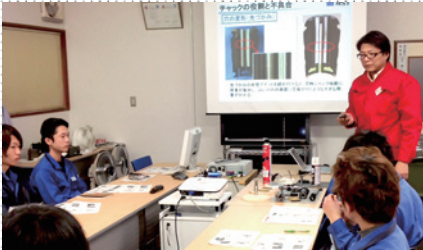

Seminar



Evaluation



Consulting

Substantial peripheral equipment

<p>Work table 6S DESK ➔ P.86</p>	<p>Holder, Tool washing machine CLEAN BOX ➔ P.88</p>	<p>TOOL CAP ➔ P.91</p>	<p>Tool set up stand ➔ P.94</p>	<p>Test bar CHECKMATE ➔ P.90</p>
		<p>Tool holder storage cabinet ➔ P.98</p>	<p>Cutter protection box ENDMILL HOUSE ➔ P.97</p>	<p>Cleaning tool ➔ P.31</p>

Instructions for use

To ensure optimum, trouble-free performance, please read this operation manual carefully before using the unit. Please contact us if your holder is damaged. We are ready to help you.

Instructions for using tool holder

Pay attention to scratches and rust.

Before using, be sure to remove anti-rust oil on the holder. Scratches and dust can reduce performance and accuracy. Please keep your holders clean with rags. Our CLEAN BOX is available for your cleaning needs.



CLEAN BOX
➔ P. 88

Storage.

Please use tool protection covers if you store holders with cutters. Cutting edges may be damaged by coming in contact with each other, and you may get injured by sharp cutting edges.



TOOL CAP
➔ P. 91



Tool holder shank.

If you insert holder shanks with scratches and dust into machine spindles, the accuracy of the spindle is reduced and the spindle can be damaged. For shank maintenance, use an oil grinding stone or sandpaper to remove scratches and rust. We cannot re-grind shank since it changes the position of gauge line, so we recommend you to purchase new holders.



Retention knob is consumable.

Exchange the retention knob regularly. (Usage period is depend on the frequency and cutting condition. Approximately 6 months for heavy duty cutting. 18 months for standard cutting.)



ANGLE HEAD

- The gear and bearing in the angle head are consumables. Periodic maintenance is required. The inside of the head can be checked by taking off the aluminum cover and the name plate.
- Be careful about the spindle rotating direction. If used in a wrong rotating direction, it will damage the gears.



DETa-1 Collet Holder

Tighten with the proper torque.

- Excessive tightening will reduce the accuracy and damage the internal components.
- An adjustable torque wrench, which can tighten the nut with the appropriate torque, is available for DTA type holders.



Adjustable torque wrench



The nut-tightening torque can be adjusted more properly.

➔ P. 31

- For the DTB3, the torque is adequate when the wrench starts to bend. Do not use T-type or L-type wrenches for tightening. If a commercially-available torque wrench is used, use a screwdriver type.



Firmly attach the DETa-1 collet to a rod.

Use a collet driver when screwing in the collet all the way until it stops. If the collet is not screwed in enough, the rod might break. The rod is replaceable.

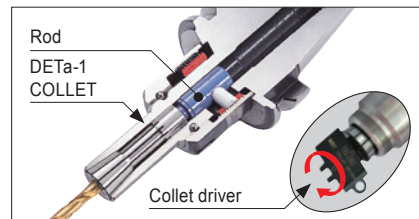

COLLET HOLDER

Do not use a collet that has a notch or nick (flaw) on its tapered surface.

In order to maintain the accuracy of the main unit, the hardness of the collet is less than that of the main unit. If the collet is used with its tapered surface having a notch or nick (flaw) in it, poor accuracy or insufficient tightening can cause an accident. Replacing the collet will allow you to restore the holder to more or less its initial precision level.

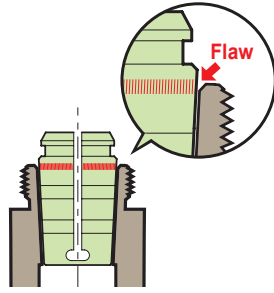

Tighten with the proper torque.

Excessive tightening will damage the holder. Clean the tool holder thoroughly inside and out when setting it up. When coolant or chips remain on the thread of the tool holder or the nut, the frictional resistance decreases. This will cause the torque to be similar to the torque experienced when over-tightening. Therefore, even if the tightening torque is correct, it might lead to breakage.

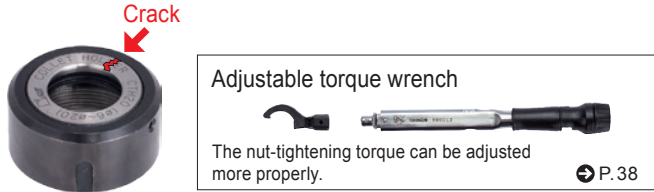

Hi-ART MILLING CHUCK

Do not tighten the collet without inserting a cutting tool.

Tightening the nut without inserting a cutter will cause the clamping portion of the holder to change shape and make it difficult to insert a cutter.



Be sure to insert the cutter shank deeper than the minimum clamping depth.

If the internal bore gets damaged, accuracy degradation, gripping torque degradation and unable insertion of the cutter might occur. Refer to "Cutter insertion length" on the chart.

Cutter shank dia.	Min. holding length	
	ART32	ART42
φ 6, 8	30	35
φ 10, 12	40	45
φ 16, 20	50	55
φ 25		
φ 32	66	60
φ 42	-	76

RED screw arbor

Confirm if a screw-in tool can be used.

Some of the screw-in end mills cannot be attached to the RED screw arbor. Please check your screw-in end mills for conformance to the dimensions, or please contact MST.

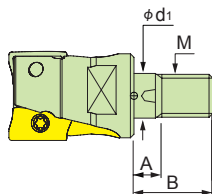

Holder type	M	φd1	A	B
RSG8	M 8	8.5	10	18
RSG10	M10	10.5	10	22
RSG12	M12	12.5	10	22
RSG16	M16	17	10	25

Precautions for collet tightening.

First set the collet into the nut. Do not first put the collet into the tool holder. The collet might get stuck in the tool holder when tightened by the nut.

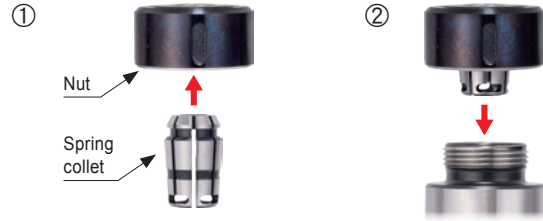

Be sure to keep the clamping length of the cutter insertion to a minimum.

Not clamping the cutter with the entire clamping length will cause degradation of accuracy, slipping out of the cutter, and breakage of the tool holder and the nut.

Collet inner diameter	Min. holding length	HOLDER CODE
φ 2.6~10	20	CTA10, CTH10
φ 6 ~20	40	CTA20, CTH20
φ 6 ~ 9.5	38	CTA25, CTH25
φ 10 ~ 15	48	
φ 15.5~25	57	CTA32, CTH32
φ 25, 28, 30, 32	68	
φ 32, 40, 42	70	CTA40

Use the holder within the allowable spindle speed.

HOLDER	MAX.min ⁻¹
BT40, A 63-ART32	6000
BT50, A100-ART32	5000
BT50, A100-ART42	3000

After removing the tool, loosen the nut by another one turn or more.

Otherwise, the next time the tool is clamped, the component of the nut might be damaged. This will also prevent you from being able to grip the tool with sufficient strength, causing the tool to slip during machining.

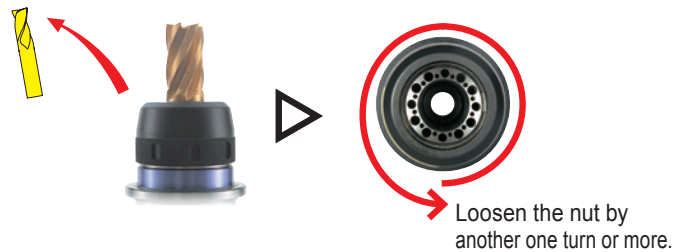

Loosen the nut by another one turn or more.

SUMMIT

Tighten the all bolts at least twice.

Tighten the bolts in the order of the numbers marked on them.

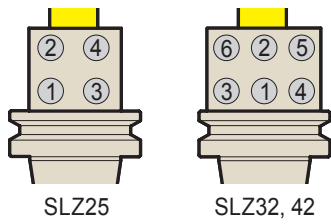

Precautions for tightening the bolts.

If you are unable to loosen the last one or two bolts, tighten all the bolts again and then try to loosen all the bolts again little by little. (This occurs when the bolts are not loosened equally and little by little from the first step.)

When loosened slowly, the wrench might bend, so loosen the bolts with instantaneous torque.

Cutter life comparison depending on different run-out accuracy

When the cutter run-out accuracy is $10\mu\text{m}$, cutter life is 2.2 times longer than with $40\mu\text{m}$ run-out accuracy.

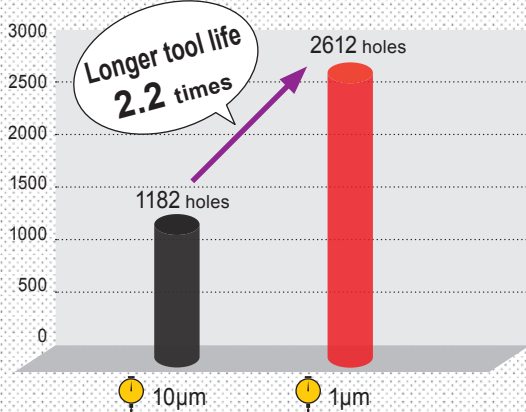

Cutting condition

Cutting tool : $\phi 0.1\text{ mm}$ drill
 Material : NAK80(40HRC)
 Coolant : Water solubility coolant
 Revolution : $20,000\text{min}^{-1}$
 Feed : 60 mm/min
 Step feed : Non-step
 Depth : 0.4 mm

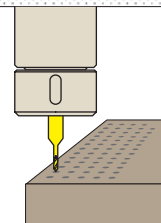

Cutter life comparison when using cutter-through coolant and external coolant

Applying the cutter-through coolant improves the tool life 3.7 times higher than when external coolant is used.

Cutter-through coolant



External coolant

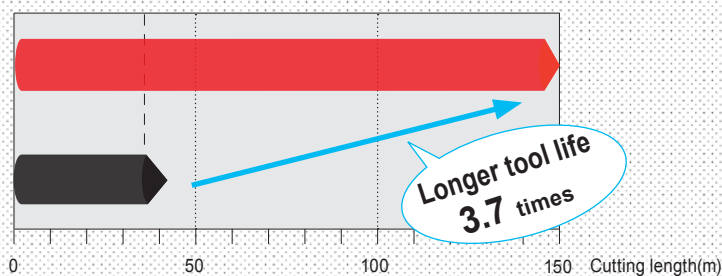
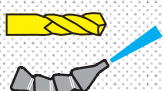

For high-speed spindle rotation

Imbalance value of a machine tool spindle and a tool holder

A tool holder imbalance value (G grade) focuses at high-speed spindle rotation of a machining center. However, it is important to consider the entire rotation body, including the spindle, holder and cutter to determine the high-speed spindle rotation. This is because the holder and cutter weight is much lighter than the spindle weight (less than approx. 1/20th), and thus the effect of a tool holder on the spindle rotating equipment (spindle, tool holder and cutter) becomes significantly smaller.

Spending time and money on balance corrections to the holder alone will not result in significant improvement.

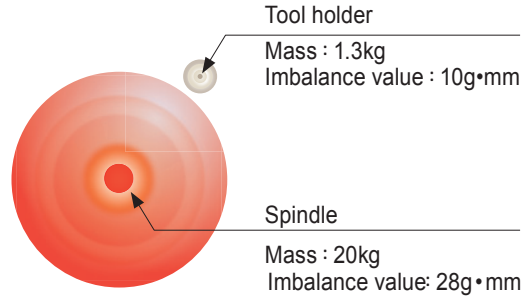
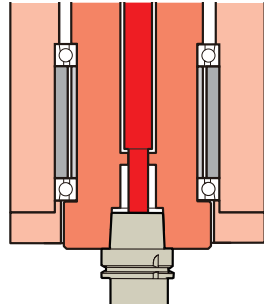
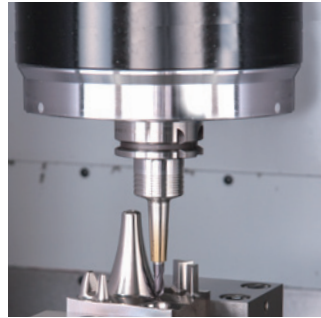

Achieving high-speed, high-efficiency machining requires more than just good balance.

- What is the run-out accuracy of the machine spindle, tool holder and cutting tool?
- Is there taper contact between the machine spindle and tool holder?
- What is the diameter of the cutting tool?
- What is the cutting speed? Spindle rotation?

Points to keep in mind at high-speed rotation.

- Minimize the length of a tool holder and cutting tool as short as possible.
- Use high accuracy and compact design tool holders.
- Optimize the cutting condition(rpm, feed and depth of cut).

MST considers these points carefully and produces a tool holder according to our own pre-balanced design concept.

Pre-balanced design

MST has applied our original pre-balancing to make the tool holders applicable for high-speed spindle rotation. Balancing corrections for our products is not required.

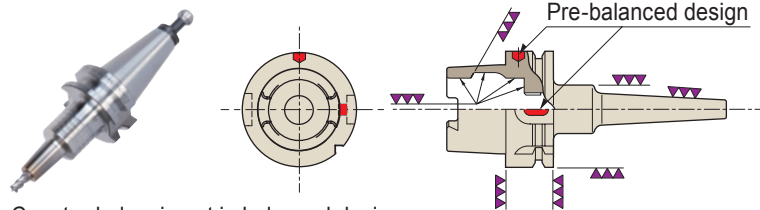

- Counter-balancing at imbalanced design areas.
- O.D finish grinding after heat treatment.

Unbalancing in terms of tolerable residual ration against the balancing grade(G grade value)

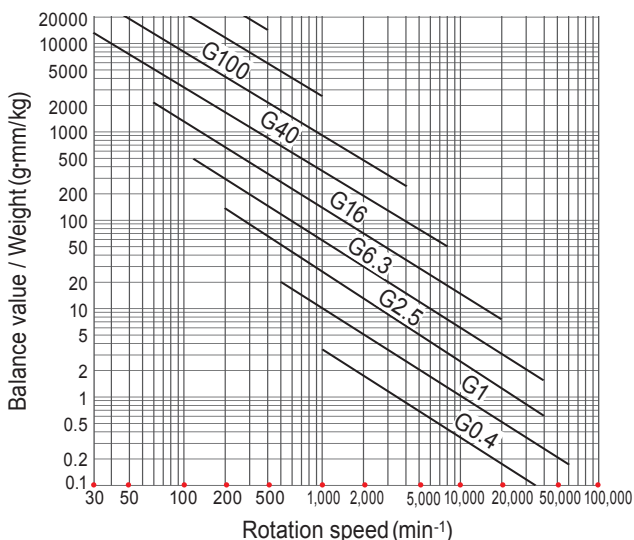

Relationship between a cutter diameter and spindle rotation

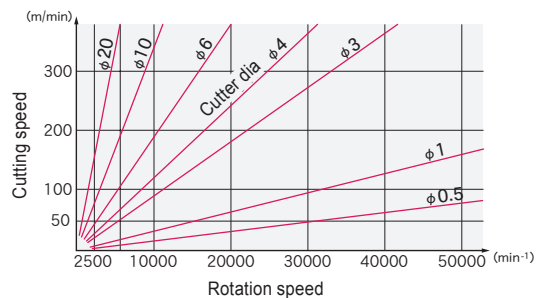

<<Reference >>

Recommend various of G grade of a rotating body

G grade	G	Rotating body
G40	~17	The car wheel
G16	~16	The parts of agricultural machines The parts of truck
G 6.3	~ 6.3	Machine tools and aviation gas- turbine rotors after assembling general mechanical parts
G 2.5	~ 2.5	The spindle of machine tool Gas turbine Steam turbine
G 1	~ 1	The grinding wheel spindle of grinding machine
G 0.4	~ 0.4	The grinding wheel spindle of precise grinding machine Gyroscope

Determining tool holder G grade

$$G = \frac{\text{Imbalance value(g·mm)}}{\text{Weight (kg)}} \times \frac{\text{Spindle rotation speed}}{9,550}$$

Holders for high-speed operation include "Imbalance value" and "holder weight" columns in the dimensions table.

Determining G grade of rotating equipment (spindle · tool holder · cutting tool)

$$G = \frac{(\text{Spindle + Holder + Cutter}) \cdot \text{Imbalance value(g·mm)}}{\text{Weight (kg)}} \times \frac{\text{Spindle rotation speed}}{9,550}$$

HSK SHANK

MST uses DIN-HSK standard shanks, which are widely used in Japan and other countries as “2-face contact tooling” for high-speed, high-efficiency machining.

- ▷ The close contact of the end faces (2-face contact) of the HSK shank results in high rigidity for transverse feed, which minimizes vibrations during machining and improves the operating life of the cutting tool and the finished surface.
- ▷ Even if the spindle expands during high-speed rotations, the tapered hollow portion comes up with that expansion, thereby maintaining high precision.



A type

The most common type in use today.



E type

This type has no drive keyway and is suitable for high-speed machining.



F type

This type uses a combination of different sizes of tapers and flanges.



T type

This type is for turning with multiple machining

Pre-Balanced design

The HSK-A-type shank is unbalanced in its standard form, but at MST we have applied our original pre-balancing to make the tool holders applicable for high-speed machining. According to DIN standards, only the area marked with ※ in the hollow shank needs to be finished. However, MST provides perfect finishing for all areas after heat treatment in order to improve balance.

	MST	DIN standard
A63	15 g·mm	75 g·mm
A100	28 g·mm	170 g·mm

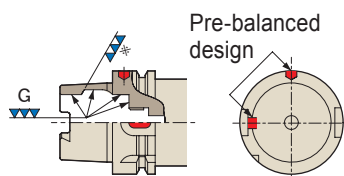

Three times stronger clamping force

HSK uses a clamping mechanism, which utilizes the wedge effect, to provide a tool gripping power 2.5 to 3.0 times greater than in the retention knob system (BT40 and BT50), thereby increasing rigidity.

	Tensile strength of draw bar	Tool clamping force
BT40	10~15kN	10~15kN
A63	5.8kN	18.4kN
BT50	20~25kN	20~25kN
A100	14.5kN	45.9kN

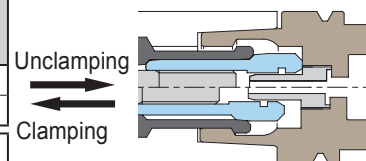

Rigidity comparison with BT shank

The HSK shank is effective when longer overhang or higher transverse feed rigidity is required. The higher rigidity greatly contributes to improve the operating life of the cutting tool and the smoothness of the finished surface.

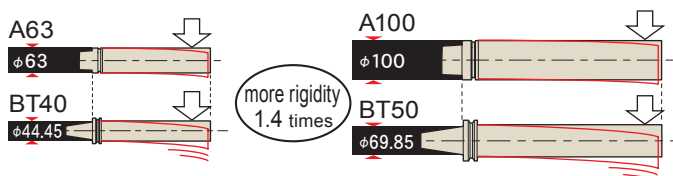

Taper gauge

MST establishes the optimal value within the tolerance in accordance with the DIN standard and manufacturers master gauges for tool shanks and those for spindle tapers accordingly.



Coolant duct

This is a coolant feed part exclusively for the HSK-A type. MST's HSK-A type holder comes standard with each coolant duct.

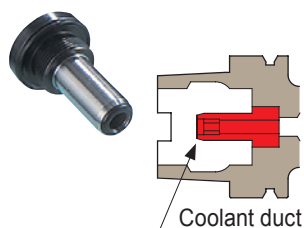

!
For some machines, the use of a coolant duct (Adjustable) is recommended. The existing coolant duct is replaced with an adjustable one at your request only when you have placed an order for the holder. →P. 104

TOOLING SYSTEMS for HSK-T

Collaborative development with 17 Japanese manufacturers has resulted in an interface for mill-turning machines based on the HSK-A type. With its 2008 ISO accreditation, it has become popular standard around the world.

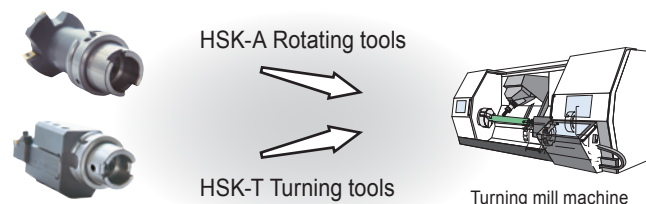

Technical data

The shank dimensions

HSK-A (Extracts from DIN 69893-1;1993-07)

Shank	A40	A50	A63	A100	A125
b1 (H10)	8	10.5	12.5	20	25
b2 (H10)	9	12	16	20	25
b3 (H10)	11	14	18	22	28
d1 (h10)	40	50	63	100	125
d2	30	38	48	75	95
d3	+0.007 +0.005	+0.009 +0.006	+0.011 +0.007	+0.015 +0.009	+0.018 +0.011
d4	29.05	36.9	46.53	72.6	91.95
d5	+0.005 +0.003	+0.006 +0.003	+0.007 +0.003	+0.009 +0.003	+0.011 +0.004
d4 (Max.)	34	42	53	85	105
d8 (H10)	21	26	34	53	67
d9 (H11)	25.5	32	40	63	80
d10	23	29	37	58	73
d11	M12 × 1	M16 × 1	M18 × 1	M24 × 1.5	M30 × 1.5
d14 (Max.)	5	6.8	8.4	12	14
e1	10.88	13.797	17.862	27.329	35.324
f1 (0/-0.1)	20	26	26	29	29
f2 (min.)	35	42	42	45	45
f3 (± 0.1)	16	18	18	20	20
f4 (+0.15/0)	2	3.75	3.75	3.75	3.75
h1 (0/-0.2)	17	21	26.5	44	55.5
h2 (0/-0.3)	12	15.5	20	31.5	39.5
l1 (0/-0.2)	20	25	32	50	63
l2	4	5	6.3	10	12.5
l3	9.5	11	14.7	24	30.5
l4 (+0.2/0)	6	7.5	10	15	19
l5 (+0.2/0)	3.5	4.5	6	10	12
l6 (JS10)	11.42	14.13	18.13	28.56	36.27
l7 (0/-0.1)	8	10	10	12.5	16
l8 (0/-0.3)	8	10	12	16	18
l12	12	19	21	24	24
r3 (+0.05/0)	1.88	2.38	2.88	4.88	5.88
r8	4.5	6	8	10	5

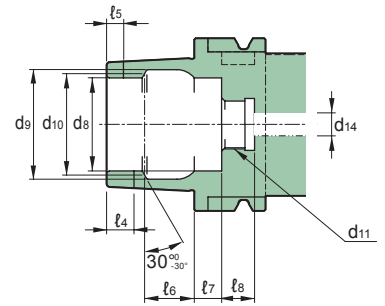
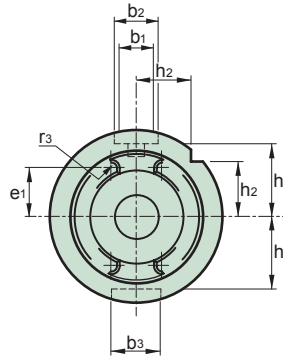
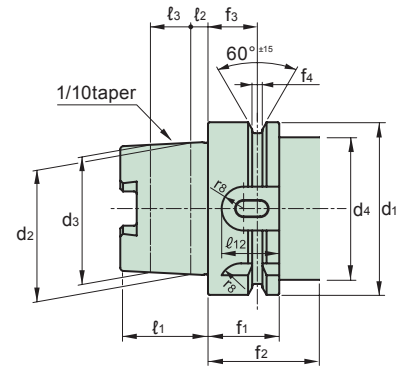

HSK-E (Extracts from DIN V 69893-5;1996-01)

Shank	E25	E32	E40	E50
d1 (h10)	25	32	40	50
d2	19	24	30	38
d3	+0.006 +0.004	+0.007 +0.005	+0.007 +0.005	+0.009 +0.006
d4	18.15	23.27	29.05	36.90
d5	+0.004 +0.002	+0.005 +0.003	+0.005 +0.003	+0.006 +0.003
d4 (Max.)	20	26	34	42
d8 (H10)	14	17	21	26
d9 (H11)	16.4	21	25.5	32
d10	15	19	23	29
d11 (Max.)	3	4.2	5	6.8
l1 (0/-0.2)	13	16	20	25
l2	2.5	3.2	4	5
l3	8.5	7.3	9.5	11
l4 (JS10)	7.21	8.92	11.42	14.13
l5 (0/-0.1)	6	8	8	10
f1 (0/-0.1)	10	20	20	26
f2 (min.)	20	35	35	42
f3 (± 0.1)	4.5	16	16	18
f4 (+0.15/0)	2	2	2	3.75

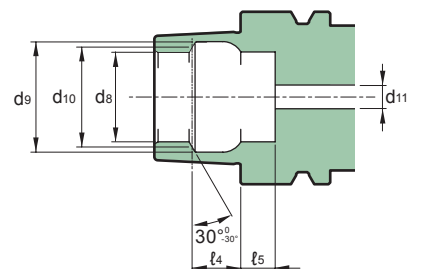
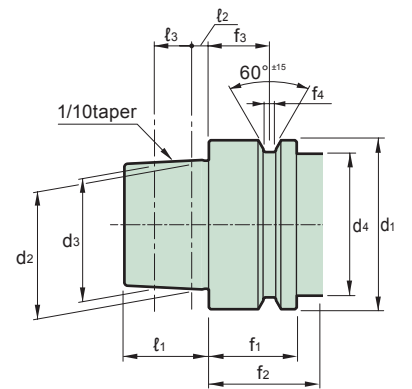

HSK-F (Extracts from DIN 69893-1;1993-07)

Shank	F63	F80
d1 (h10)	63	80
d2	38	48
	+0.009 +0.006	+0.011 +0.007
d3	36.9	46.53
d3	+0.006 +0.003	+0.007 +0.003
	d4 (Max.)	53
d8 (H10)	26	34
d9 (H11)	32	40
d10	29	37
f1 ($-\frac{0}{0.1}$)	26	26
f2 (min.)	42	42
f3 (± 0.1)	18	18
f4 ($+\frac{0.15}{0}$)	3.75	3.75
l1 ($-\frac{0}{0.2}$)	25	32
l2	5	6.3
l3	11	14.7
l4 (Js10)	14.13	18.13
l5 ($-\frac{0}{0.1}$)	10	10
f1 ($-\frac{0}{0.1}$)	26	26
f2 (min.)	42	42
f3 (± 0.1)	18	18
f4 ($+\frac{0.15}{0}$)	3.75	3.75

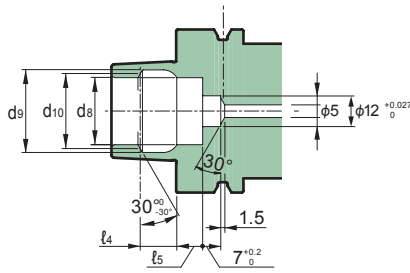
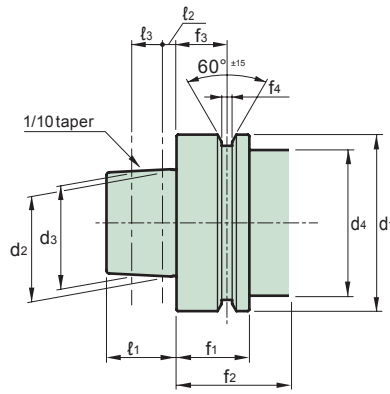

HSK-T (Extracts from DIN 69893-1;1993-07) For turning with turning mill machines

Shank	T40	T50	T63	T100	T125
b1 ($+\frac{0.024}{0}$)	8.05	10.54	12.54	20.02	25.02
b2 (H10)	9	12	16	20	25
b3 (H10)	11	14	18	22	28
b5	7.932	10.425	12.425	19.91	24.915
	+0.03 0		+0.035 0		+0.04 0
d1 (h10)	40	50	63	100	125
d2	30.007	38.009	48.010	75.013	95.016
d3 (H10)	21	26	34	53	67
d4 (H11)	25.5	32	40	63	80
d5	23	29	37	58	73
d6 (Max.)	5	6.8	8.4	12	14
d9 (Max.)	39	49	62	99	124
d15	M12 x 1	M16 x 1	M18 x 1	M24 x 1.5	M30 x 1.5
e1	11	13.88	17.99	27.37	35.37
f1 ($-\frac{0}{0.1}$)	20	26	26	29	29
f2 (min.)	23	30	30	34	34
f3 (± 0.1)	16	18	18	20	20
f4 ($+\frac{0.15}{0}$)	2	3.75	3.75	3.75	3.75
h1 ($-\frac{0}{0.2}$)	17	21	26.5	44	55.5
h2 ($-\frac{0}{0.2}$)	12	15.5	20	31.5	39.5
l1 ($-\frac{0}{0.2}$)	20	25	32	50	63
l2	4	5	6.3	10	12.5
l3 ($+\frac{0}{0.2}$)	6	7.5	10	15	19
l4 ($-\frac{0.2}{0}$)	3.5	4.5	6	10	12
l5 (JS10)	11.42	14.13	18.13	28.56	36.27
l6 ($-\frac{0}{0.1}$)	8	10	10	12.5	16
l9 ($-\frac{0}{0.1}$)	8	10	12	16	18
l12	12	19	21	24	24
r3 ($+\frac{0.05}{-0.05}$)	1.88	2.38	2.88	4.88	5.88
r9	4.5	6	8	10	5

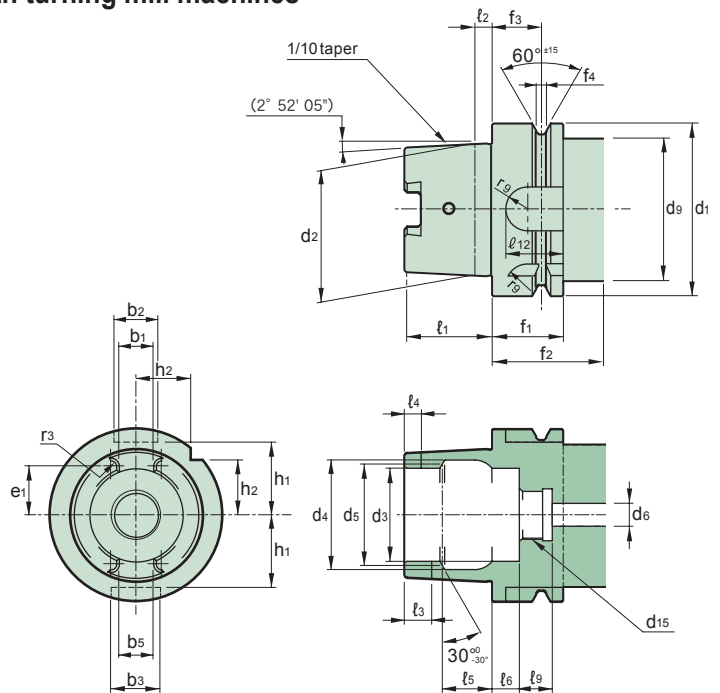

BT (Extracts from MAS 403)

Shank	BT30	BT40	BT50
D₁	31.75	44.45	69.85
ℓ₁ (± 0.15)	48.4	65.4	101.8
d₂ (H8)	12.5	17	25
g (6H)	M12	M16	M24
ℓ₂ (min.)	24	30	45
ℓ₃ (min.)	34	43	62
ℓ₄	7	9	13
b (H12)	16.1	16.1	25.7
ℓ₅ (min.)	17	21	31
t (-0.2)	16.3	22.6	35.4
D₅ (h8)	46	63	100
f	20	25	35
v (± 0.1)	13.6	16.6	23.2
y (± 0.4)	2	2	3

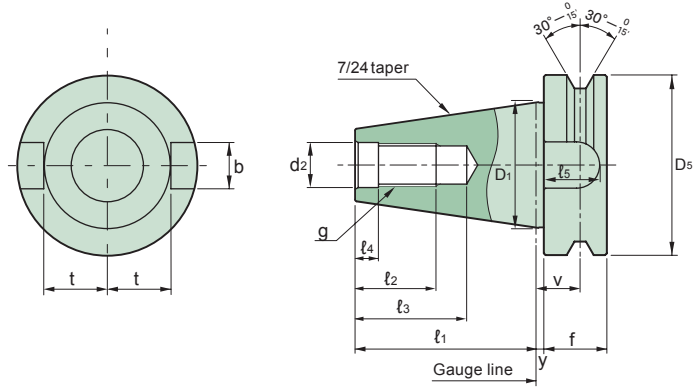

DIN (DIN69871-1)

Shank	DN40	DN50
D₁	44.45	69.85
D₂	63.55	97.5
D₃	56.25	91.25
D₄	50	80
L₁	68.4	101.75
L₃	3.75	6.495
b₁	16.1	25.7
d₁	17	25
t₁	22.8	35.5
t₂	25	37.7
t₃	18.5	30

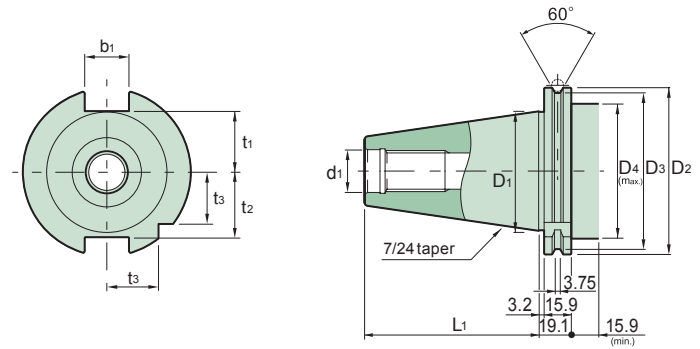

CAT.

Shank	CT40	CT50
D₁	1.75	2.75
D₂	2.5	3.88
D₃	2.22	3.59
D₄	1.75	2.75
L₁	2.69	4
b₁	.65	1.06
d₁	.64	1.03
t₁	.99	1.49
t₂	.84	1.39

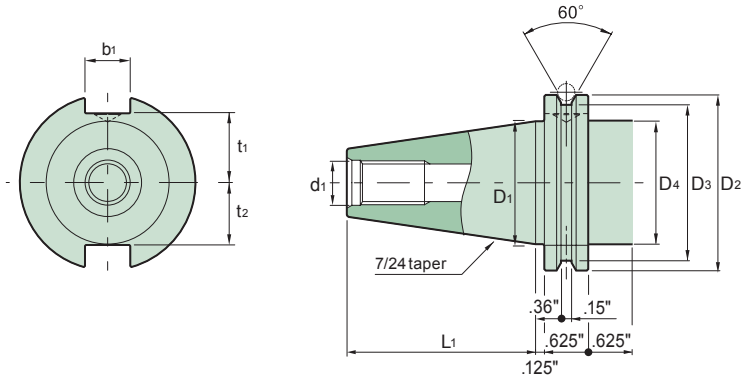

HSK-A125/ F80PD are also available as standard products.

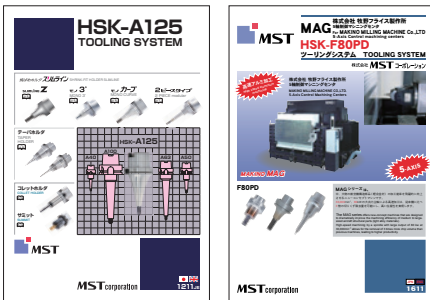

If you would like more detailed information, please contact MST and ask for a catalog.

Drill hole size in metric coarse screw thread

Nominal size x pitch	Drill hole dia.
M 1 ×0.25	0.75
M 1.2×0.25	0.95
M 1.6×0.35	1.25
M 2 ×0.4	1.6
M 2.5×0.45	2.1
M 3 ×0.5	2.5
M 4 ×0.7	3.3
M 5 ×0.8	4.2
M 6 ×1	5
M 8 ×1.25	6.8
M10 ×1.5	8.5
M12 ×1.75	10.3
M16 ×2	14
M20 ×2.5	17.5
M24 ×3	21
M30 ×3.5	26.5
M33 ×3.5	29.5
M36 ×4	32
M39 ×4	35
M42 ×4.5	37.5
M45 ×4.5	40.5
M48 ×5	43

Drill hole size in unified screw threads

Nominal size x pitch	Drill hole dia.
NO. 1 - 64UNC	1.55
NO. 2 - 56UNC	1.8
NO. 3 - 48UNC	2.1
NO. 4 - 40UNC	2.3
NO. 5 - 40UNC	2.6
NO. 6 - 32UNC	2.8
NO. 8 - 32UNC	3.4
NO.10 - 24UNC	3.9
NO.12 - 24UNC	4.5
1/4 - 20UNC	5.1
5/16 - 18UNC	6.6
3/8 - 16UNC	8
7/16 - 14UNC	9.4
1/2 - 13UNC	10.8
9/16 - 12UNC	12.2
5/8 - 11UNC	13.6
3/4 - 10UNC	16.5
7/8 - 9UNC	19.5
1 - 8UNC	22.2
1 1/8 - 7UNC	25
1 1/4 - 7UNC	28.2
1 3/8 - 6UNC	30.8
1 1/2 - 6UNC	34
1 3/4 - 5UNC	39.5

Drill hole size in screw for pipe

Nominal size	Rc(PT)	Rp(PS)	G(PF)
1/8	8.2	8.5	8.8
1/4	10.9	11.4	11.87
3/8	14.4	14.9	15.38
1/2	18	18.5	19.1
5/8	—	—	21
3/4	23	24	24.6
7/8	—	—	28.3
1	29	30	30.9
1 1/8	—	—	35.5
1 1/4	38	39	39.4
1 1/2	44	45	45.4

Dia. of tap shank



Metric screw threads	Unified screw threads	Gas screw threads	φD2
φD1			
M 1~M 2.6	UNo. 0~ 4		3
M 3~M 3.5	UNo. 5 · 6		4
M 4~M 4.5	UNo. 8		5
M 5~M 5.5	UNo.10 ·12		5.5
M 6	U 1/4		6
	U 5/16		6.1
M 7~M 8			6.2
M 9~M10	U 3/8		7
M11	U 7/16	P1/16 · 1/8	8
M12			8.5
	U 1/2		9
M13			9.5
M14~M15	U 9/16		10.5
		P 1/4	11
	U 5/8		12
M16			12.5
M17			13
M18	U 3/4	P 3/8	14
M20			15
M22	U 7/8		17
		P 1/2	18
M24~M25		P 5/8	19
M26~M27	U1		20
M28			21
	U1 1/8		22
M30		P 3/4	23
M32	U1 1/4	P 7/8	24
M33			25
M35	U1 3/8	P1	26
M36~M38		P1 1/8	28
M39~M40	U1 1/2		30
M42	U1 5/8	P1 1/4	32
M45	U1 3/4	P1 3/8	35
M48		P1 1/2	38
M50	U2	P1 5/8	40
M52		P1 3/4	42

Dimensional tolerance of typically used mating (JIS B 0401)

The class of dimension(mm)		The tolerance of the hole dimension(μm)						The tolerance of the shaft dimension(μm)					
More than	Less than	H4	H5	H6	H7	H8	H9	h4	h5	h6	h7	h8	h9
—	3	+3 0	+4 0	+6 0	+10 0	+14 0	+25 0	0 -3	0 -4	0 -6	0 -10	0 -14	0 -25
3	6	+4 0	+5 0	+8 0	+12 0	+18 0	+30 0	0 -4	0 -5	0 -8	0 -12	0 -18	0 -30
6	10	+4 0	+6 0	+9 0	+15 0	+22 0	+36 0	0 -4	0 -6	0 -9	0 -15	0 -22	0 -36
10	18	+5 0	+8 0	+11 0	+18 0	+27 0	+43 0	0 -5	0 -8	0 -11	0 -18	0 -27	0 -43
18	30	+6 0	+9 0	+13 0	+21 0	+33 0	+52 0	0 -6	0 -9	0 -13	0 -21	0 -33	0 -52
30	50	+7 0	+11 0	+16 0	+25 0	+39 0	+62 0	0 -7	0 -11	0 -16	0 -25	0 -39	0 -62
50	80	+8 0	+13 0	+19 0	+30 0	+46 0	+74 0	0 -8	0 -13	0 -19	0 -30	0 -46	0 -74
80	120	+10 0	+15 0	+22 0	+35 0	+54 0	+87 0	0 -10	0 -15	0 -22	0 -35	0 -54	0 -87
120	180	+12 0	+18 0	+25 0	+40 0	+63 0	+100 0	0 -12	0 -18	0 -25	0 -40	0 -63	0 -100
180	250	+14 0	+20 0	+29 0	+46 0	+72 0	+115 0	0 -14	0 -20	0 -29	0 -46	0 -72	0 -115
250	315	+16 0	+23 0	+32 0	+52 0	+81 0	+130 0	0 -16	0 -23	0 -32	0 -52	0 -81	0 -130
315	400	+18 0	+25 0	+36 0	+57 0	+89 0	+140 0	0 -18	0 -25	0 -36	0 -57	0 -89	0 -140
400	500	+20 0	+27 0	+40 0	+63 0	+97 0	+155 0	0 -20	0 -27	0 -40	0 -63	0 -97	0 -155

Conversion table for International System of Units

Force		Pressure		Stress	
N	kgf	Pa	kgf/cm ²	Pa	kgf/mm ²
1	1.01972×10 ⁻¹	1	1.01972×10 ⁻⁵	1	1.01972×10 ⁻⁷
9.80665	1	9.80665×10 ⁴	1	9.80665×10 ⁶	1

INDEX

	CODE	NAME	Page		
ANGLE HEAD	AB - 15	Semi-finished positioning block	19		
	ABF005	Positioning block for machines	7		
	BT40 - AHA20 - 160	ANGLE HEAD SOLID type	16		
	F190 - AHA20 - 200	ANGLE HEAD FLANGE type	17		
	BT50 - AHB5 - 225	ANGLE HEAD MODULAR type	15		
	BT50 - AHC10 - 245				
	BT50 - AHA25 - 250	ANGLE HEAD SOLID type	16		
	BT50 - AHD30 - 195				
	BT40 - AHU10 - 175	ANGLE HEAD UNIVERSAL type	18		
	AJB - M6 - L	Adjust bolt (WIRE CUT UNIT)	102		
	AJC - M14	Adjust screw (COLLET HOLDER)	37		
	AJN - M18L	Adjust screw (Hi-ART Milling chuck)	44		
	AP40 - T30V	Adapter (Petit Ball / MY CUBE)	95		
	BT50 - ART32 - 105	Hi-ART Milling chuck	42, 104		
AW - 1	Adjustable torque wrench	31, 38, 103			
M/C Tool	T50 - BL40 - 42	BLANK TOOL (Tool for turning mill)	72		
	C10 - 6	SPRING COLLET	8, 38		
	C10 - A set	SPRING COLLET Standard set	38		
	C10 - RM	Collet remover	38		
	T63 - CAAx52 - 150	CHECKING ARBOR	72		
	CAP2022	Cap dispenser	92		
	CBX - 01	CLEAN BOX	88		
	T63 - CC32 - 90	Set screw holders for Round shank	69		
	CCD094 - PA	Insert	62		
	CD40 - 01	Coolant duct (fixed)	104		
	CD50 - A1	Coolant duct (Dummy duct)	104		
	CD63 - 01F	Coolant duct (Adjustable)	104		
	CE - CTS10	Collet remover	38		
	ST6 - CEB102	Centering bar	84		
General Purpose Tool	C	CF12 - 4 - 35	SLIMLINE collet	※	
		CLP - 7E	Coolant cap	30	
		CLP - 101	Clamper (WIRE CUT UNIT)	102	
		NT30 - CMA - 20 - 125	TEST BAR CHECKMATE	90	
		HSK32 - CMB - 25 - 175			
		CN - 103	Container box	98	
		T100 - CN40 - 115	Set screw holders for Round shank	69	
		CP - 14M	Coolant screw	39	
		CR12.6.55	SLIMLINE collet	※	
		CS12.3.80			
		CSA - M14	Coolant screw	39	
		CSR - 14	Coolant screw (COLLET HOLDER)	39	
		BT30 - CTA10 - 45	COLLET HOLDER	36	
		BT50 - CTH10 - 105	COLLET HOLDER for high-speed	34	
	E32 - CTS10 - 50		35		
JIG	D	D7 - 1.5	DETA-1 COLLET	31	
		A40 - DOC17.5 - 55	Dovetail clamping (SMART GRIP)	78	
		A63 - DOV110I	Dovetail vise (SMART GRIP)	79	
		DR - 1	Collet driver	31	
		BT40 - DTA3 - 95	DETA-1 COLLET HOLDER A type	24	
		BT50 - DTB7 - 75	DETA-1 COLLET HOLDER B type	26	
		A50 - DTE7 - 105	DETA-1 COLLET HOLDER E type	28	
		DW - 2.5 - 110	Wrench	31, 103	
	Measuring Equipment	E	7EA - 3.5 - 3	Spacer	30
			12EBF - BL - 5		
			12EBM - 3 - 3		
			12EBS - 3.6 - 3		
			EMO - STD3 - 2	ENDMILL HOUSE	97
			ER8 - 4	SPRING COLLET	19
		7ES - A	Spacer set	30	
		ESX12 - 6	SPRING COLLET	19	
Maintenance Tool					
Wire EDM fixture					
	Technical Information				

	CODE	NAME	Page	
F	F - 38	Spanner	38, 103	
	F - 38AW	Spanner for torque wrench	31, 103	
	F160H32 - A40	Mounting plate (SMART GRIP)	78	
	F100H21 - A40 - 50	The Manual clamping head (SMART GRIP)	78	
	F100S65 - A63 - 89	The Automation clamping head (SMART GRIP)	81	
	FC - 32	Spanner	38, 103	
	FC - 36AW	Spanner for torque wrench	38, 103	
	FCS6 - 3	Shrink-fit collet	10	
	FCS6 - M4	Tap collet	10	
	FKA - 60	Stationary bracket (ANGLE HEAD HALF)	105 ~	
	FKB - 60			
	FKC - 50			
	FM - 72	Spanner with ejection hook (Hi-ART MILLING CHUCK)	42, 103	
	BT40 - FMH16 - 29 - 45	Cutter arbor with spindle-through coolant	53	
BT50 - FMH22 - 47 - 165H	FMH RIGID type	47		
A40 - FP40-35	Flange clamping (SMART GRIP)	79		
G	GRP - 002	Grip	102	
H	HB - 01	Semi-finished positioning block (ANGLE HEAD HALF)	7	
	HBX - A40	TOOL HOLDER STORING CABINET	98	
	HF - BT30	Tool set up stand (Vice clamping type)	95	
	BT30 - HFA10 - 120	ANGLE HEAD HALF 90° type	9	
	BT30 - HFCS6 - 155	ANGLE HEAD HALF mini type	10	
	BT40 - HFD7 - 120	ANGLE HEAD HALF 90° type	9	
	BT30 - HFT4 - 122			
	HP-50S	Positioning pin (ANGLE HEAD HALF)	105 ~	
	BT40 - HUA10 - 135	ANGLE HEAD HALF UNIVERSAL type	12	
	BT30 - HUD7 - 102			
	BT30 - HUT4 - 102			
	I	IR 15 - A40FP	Positioner boss (SMART GRIP)	79
	J	JAE - 501	Extension Jaw	100
	K	KJ - 45	Insert and insert holder set	62
M	MB5 - 112	Head	15	
	MBF-M12	Clamp bolt (Cutter arbor with spindle-through coolant)	54	
	BT40 - MBH50 - 150	MICRO HEAD MBH type	59	
	BT30 - MBJ45 - 120	MICRO HEAD MBJ45 type	61	
	BT50 - MBJ70 - 165	MICRO HEAD MBJ70 type	62	
	MC10 - 132	Head	15	
	MDV - 501	MIDDLE VISE	99	
	BT50 - MFA20 - 165	MICRO HEAD MFA type	57	
	BT40 - MS - 98	Shank	15	
	MS2 - 30	Extension	57	
	MU - S6H	UNIVERSAL FACING BORING HEAD	73	
	MY CUBE50	MY CUBE	95	
	NOZ - M6 - 12	Nozzle	42, 44, 103	
	N	NUA - CTA10	Nut	37, 104
NUB - CTH10 - 3.6	SUKIMA nut	39, 104		
P	P30T - 1	Retention knob	64	
	P - 445			
	P - 535/538	Retention knob (BT30-DTB12)	27	
	PA - R - 1	PALETTE	96	
	PCT01 - 10	Cleaning tool felt type	31	
	PETIT BALL40	Petit Ball	95	
	PJ - 45	Insert and insert holder set	62	
	PR - DTA3	Rod (DETA-1 COLLET HOLDER DTA3 type)	25	
	PTC10	Cartridge (MICRO HEAD MBH type)	60	
	PTE - 001	Extension Plate	101	
	RC - 26	CTS Special wrench	38, 103	
	R	RS - A63 - A40	Adapter (SMART GRIP)	79
	BT40 - RSG8 - 105 - M25	RED SCREW arbor	49	

	CODE	NAME	Page
S	S42 - 6F	Straight collet	42
	S - STA12	Insert holder	62
	S - STV1&22		
	T63 - SA2525 - 105	Insert holders for Square-shank	70
	T63 - SB2525 - 95		71
	T50 - SC2020R - 95		
	T40 - SH2020 - 75		72
	A40 - SCD20 - 55		Side clamp B(SMART GRIP)
	A40 - SCS10 - 40	Side clamp A(SMART GRIP)	80
	BT50 - SLFB4 - 90 - M22	SLIMLINE MONO series	※
	BT50 - SLK12 - 75	SLIMLINE 2PIECE type Master holder	※
	BT50 - SLRA4 - 110 - M42	SLIMLINE MONO series SLIMLINE STRAIGHT ARBOR	※
	BT50 - SLRB8 - 110 - M42		
	BT50 - SLSA4 - 140 - M42		
	BT50 - SLSB8 - 140 - M42		
	A100 - SLZ25 - 135	SUMMIT	44
	T50 - SN2020R - 110	Insert holders for Square-shank	71
	SRC - 501	Clamp on Slider	100
	SRL - 501	L Slider	
	SRS - 501	Sandwich Slider	
	SRV - 501	V Slider	
	SRV - 01	Dedicated bracket	92
	SS32 - 8	Sleeve for a set screw holders	69
STB - M6 - L	Stud bolt	102	
STGP10	Cartridge	60	
STH18	Insert holder	62	
STV - C12055		61	
T40 - SV2020R - 90	Insert holders for Square-shank	70	
T	TA4 - M2	Tap sleeve	8
	TBU10	Test bar	18
	TCA2022 - 10	TOOL CAP TCA type	92
	TCB0820 - 10	TOOL CAP TCB type	
	TCC0607 - 50	TOOL CAP TCC type	93
	TCC - F	Variety set	93
	TNB114 - PB	MICRO HEAD MBH type	60
	TPA082 - PA	MICRO HEAD MFA type	57
	TPC112 - PA	MICRO HEAD MBJ/MBH type	62
	TPE042 - PA	MICRO HEAD MBJ type	61
	TR - 5	Tap rod (DETA-1 COLLET HOLDERDEtype)	30
TW - 4	Wrench	31, 103	
W	W - 206	Wrench	44, 103
	W - 135DR	Spanner · Wrench	31, 103
	WCU - A	WIRE CUT UNIT	101
Z	BT40 - ZPB - 200	Goo CHECKER	83
	BT40 - ZPM - 150	(Set up the original point on the Z axis / measuring tool for reference position)	
123	6SD - 01	6S DESK	86

※See our dedicated catalog for shrink-fit holder SLIMLINE.
For details, please contact us.

INDEX

	NAME	CODE	Page	
ANGLE HEAD	Adapter(Petit Ball / MY CUBE)	AP40 - T30V	95	
	Adapter(SMART GRIP)	RS - A63 - A40	79	
	Adjust bolt (WIRE CUT UNIT)	AJB - M6 - L	102	
	Adjust screw (SUMMIT)	AJN - M18L	44	
	Adjust screw (COLLET HOLDER)	AJC - M14	37	
	Adjustable torque wrench	AW - 1	103	
	ANGLE HEAD HALF 90°type	BT30 - HFA10 - 120	9	
		BT40 - HFD7 - 120		
		BT30 - HFT4 - 122		
	ANGLE HEAD HALF mini type	BT30 - HFCS6 - 155	10	
		ANGLE HEAD HALF UNIVERSAL type	BT40 - HUA10 - 135	12
			BT30 - HUD7 - 102	
		BT30 - HUT4 - 102		
ANGLE HEAD FLANGE type	F190 - AHA20 - 200	17		
ANGLE HEAD MODULAR type	BT50 - AHB5 - 225	15		
	BT50 - AHC10 - 245			
ANGLE HEAD SOLID type	BT40 - AHA20 - 160	16		
	BT50 - AHD30 - 195			
ANGLE HEAD UNIVERSAL type	BT40 - AHU10 - 175	18		
The Automatic clamping head (SMART GRIP)	F100S65 - A63 - 89	81		
M/C Tool	B BLANK TOOL (Tool for turning mill)	T50 - BL40 - 42	72	
	Cap dispenser	CAP2022	92	
	Cartridge (MICRO HEAD MBH type)	PTC10	60	
		STGP10		
	Centering bar	ST6 - CEB102	84	
	CHECKING ARBOR	T63 - CAAX52 - 150	72	
	Clamp bolt (Cutter arbor with spindle-through coolant)	MBF - M12	54	
	Clamper (WIRE CUT UNIT)	CLP - 101	102	
	CLEAN BOX	CBX - 01	88	
	Cleaning tool wiper type	PCT01 - 10	31	
	Collet driver	DR - 1	31	
	COLLET HOLDER	BT30 - CTA10 - 45	36	
	COLLET HOLDER for high-speed	BT50 - CTH10 - 105	34	
E32 - CTS10 - 50		35		
Collet remover		CE - CTS10	38	
	C10 - RM			
Container box	CN - 103	98		
Coolant screw (COLLET HOLDER)	CSA - M14	39		
	CP - 14M			
	CSR - 14			
Coolant cap	CLP - 7E	30		
Coolant duct (Adjustable)	CD63 - 01F	104		
Coolant duct (Dummy duct)	CD50 - A1			
Coolant duct (fixed)	CD40 - 01			
Cutter arbor with spindle-through coolant	BT40 - FMH16 - 29 - 45	53		
Dedicated bracket (TOOL CAP TCA type)	SRV - 01	92		
	DETa-1 COLLET	D7 - 1.5	31	
	DETa-1 COLLET HOLDER A type	BT40 - DTA3 - 95	24	
	DETa-1 COLLET HOLDER B type	BT50 - DTB7 - 75	26	
	DETa-1 COLLET HOLDER E type	A50 - DTE7 - 105	28	
	Dovetail clamping (SMART GRIP)	A40 - DOC17.5 - 55	78	
	Dovetail vise A,B (SMART GRIP)	A63 - DOV110I	79	
ENDMILL HOUSE	EMO - STD3 - 2	97		
	Extension (MICRO HEAD MFA type)	MS2 - 30	57	
	Extension Jaw (MIDDLE VISE)	JAE - 501	100	
Extension Plate (WIRE CUT UNIT)	PTE - 001	101		
Flange clamping (SMART GRIP)	A40 - FP40-35	79		
	FMH RIGID type	BT50 - FMH22 - 47 - 165H	47	

	NAME	CODE	Page
G	Goo Checker	BT40 - ZPB - 200	83
		BT40 - ZPM - 150	
Grip	GRP - 002	102	
H	Head (ANGLE HEAD MODULAR type)	MB5 - 112	15
		MC10 - 132	
Hi-ART MILLING CHUCK	BT50 - ART32 - 105	41	
I	Insert holder(MICRO HEAD)	S - STA12	62
		STH18	
		STV - C12055	61
		s-STV1822	62
	Insert and insert holder set (MICRO HEAD)	KJ - 45	62
	PJ - 45		
Insert holders for Square-shank	T63 - SA2525 - 105	70	
	T63 - SB2525 - 95	71	
	T50 - SC2020R - 95		
	T40 - SH2020 - 75	72	
	T50 - SN2020R - 110	71	
	T40 - SV2020R - 90	70	
MICRO HEAD MBH type	BT40 - MBH50 - 150	59	
	TNB114 - PB	60	
MICRO HEAD MBJ45 type	BT30 - MBJ45 - 120	61	
	TPE042 - PA		
MICRO HEAD MBJ70 type	BT50 - MBJ70 - 165	62	
MICRO HEAD MBJ/MBH type	TPC114 - PA	62	
MICRO HEAD MFA type	BT50 - MFA20 - 165	57	
	TPA082 - PA		
MIDDLE VISE	MDV - 501	99	
Mounting plate (SMART GRIP)	F160H32 - A40	78	
MY CUBE	MY CUBE50	95	
N	Nozzle	NOZ - M6 - 12	42, 44, 103
	Nut (COLLET HOLDER)	NUA - CTA10	37, 104
P	PALETTE (Collet stand)	PA - R - 1	96
	PETIT BALL	PETIT BALL40	95
	Positioner boss (SMART GRIP)	IR15 - A40FP	79
	Positioning block (ANGLE HEAD HALF)	ABF005	7
Positioning pin (ANGLE HEAD HALF)	HP - 50S	105 ~	
R	RED SCREW arbor	BT40 - RSG8 - 105 - M25	49
	Retention knob	P30T - 1	64
		P - 455	
	Rod (DETa-1 COLLET HOLDER DTA3 type)	PR - DTA3	25
	Retention knob (BT30-DTB12)	P - 535/538	27
Semi-finished positioning block	AB - 15	19	
Semi-finished positioning block (ANGLE HEAD HALF)	HB - 01	7	
Set screw holders for Round shank	T63 - CC32 - 90	69	
	T100 - CN40 - 115		
Shank (ANGLE HEAD)	BT40 - MS - 98	15	
Shrink-fit collet (ANGLE HEAD HALF mini type)	FCS6 - 3	10	
Side clamp A (SMART GRIP)	A40 - SCS10 - 40	80	
	A40 - SCD20 - 55		
Sleeve for a set screw holder	SS32 - 8	69	
Slider (MIDDLE VISE)	SRC/SRL/SRS/SRV	100	
SLIMLINE 2PIECE type Master holder	BT50 - SLK12 - 75	※	
SLIMLINE collet	CF12 - 4 - 35		
	CR12-6-55		
	CS12-3-80		
SLIMLINE MONO series	BT50 - SLFB4 - 90 - M22		
	BT50 - SLRA4 - 110 - M42		
	BT50 - SLRB4 - 110 - M42		
	BT50 - SLSA4 - 140 - M42		
	BT50 - SLSB4 - 140 - M42		
Spacer (DETa-1 COLLET HOLDER DTE type)	7EA - 3.5 - 3	30	
	12EBF - BL - 5		
	12EBM - 3 - 3		
	12EBS - 3.6 - 3		
Spacer set (DETa-1 COLLET HOLDER DTE type)	7ES - A	30	

	NAME	CODE	Page
	Spanner	F/FC/FF/FM	103
	SPRING COLLET (COLLET HOLDER)	C10 - 6	8, 38
		ER8 - 4	19
		ESX12 - 6	
	SPRING COLLET Standard set (COLLET HOLDER)	C10 - A set	38
S	Stationary bracket (ANGLE HEAD HALF)	FKA - 60	105 ~
		FKB - 60	
		FKC - 50	
	Straight collet (Hi-ART MILLING CHUCK)	S42 - 6F	42
	Stud bolt (WIRE CUT UNIT)	STB - M6 - L	102
	Sukima nut (COLLET HOLDER)	NUB - CTH10 - 3.6	39, 104
	SUMMIT	A100 - SLZ25 - 135	44
	Tap collet (ANGLE HEAD HALF mini type)	FCS6 - M4	10
	Tap rod (DETA-1 COLLET HOLDER DTE type)	TR - 5	30
	Tap sleeve (ANGLE HEAD HALF)	TA4 - M2	8
	TEST BAR (ANGLE HEAD UNIVERSAL type)	TBU10	18
	TEST BAR CHECKMATE	NT30 - CMA - 20 - 125	90
		HSK32 - CMB - 25 - 175	
T	The Manual clamping head (SMART GRIP)	F160H32 - A40 - 50	78
	Throw-away tip (MICRO HEAD MBJ type)	CCD094 - PA	62
	TOOL CAP TCA type	TCA2022 - 10	92
	TOOL CAP TCB type	TCB0820 - 10	
	TOOL CAP TCC type	TCC0607 - 50	93
	TOOL HOLDER STORING CABINET	HBX - A40	98
	Tool set up stand (Vice clamping type)	HF - BT30	95
U	UNIVERSAL FACING BORING HEAD	MU - S6H	73
V	Variety set (TOOL CAP TCC type)	TCC - F	93
W	WIRE CUT UNIT	WCU - A	101
	Wrench	DW/RC/TW/W	103
123	6S DESK	6SD - 01	86

※See our dedicated catalog for shrink-fit holder SLIMLINE.
For details, please contact us.

OVERSEAS NETWORK

Logistic center (J-COMPO) • USA/Chicago • Germany/Nuremburg • Thai



1809

< Europe >

AUSTRIA 1 distributor		BELGIUM 2 distributors	
STEINDL Vertriebs GmbH Söding info@steindl.at TEL 43-3137272240 FAX 43-3137272246		DIATOOl BVBA TURNHOUT MR. GELDHOF TEL 32-14401830 info@diatool.be FAX 32-14438880	
		MachinImmo BVBA LOKEREN MR. MANU COPPENS TEL 32-93288811 mc@machinimmo.com	
CZECH REPUBLIC 2 distributors		FINLAND 1 distributor	
Creative Tools s.r.o. SKALKKA MR. PETR CHYTL TEL 420-725588988 info@creative-tools.cz FAX 420-582384485		OSG BRATISLAVA MR. AKINORI FUJIYAMA TEL 421-43291295 afujiyama@osgeurope.com	
		OY FMS TOOLS AB HELSINKI info@fmstools.fi TEL 358-98190950 FAX 358-98190950	
DENMARK 2 distributors		GERMANY 3 distributors	
Balling Maskiner ApS KOLDING MR. MICHAEL BALLING PETERSEN TEL 45-24790300 mbp@balling-maskiner.dk		OSG SCANDINAVIA A/S ROSKILDE osg@osg-scandinavia.com TEL 45-46756555 FAX 45-46756700	
		Aura Frästechnik GMBH BREIDENBACH MR. MAIK BRADO TEL 49-64659119414 kontakt@aura-tools.de FAX 49-64659119429	
FRANCE 2 distributors		MAKINO GMBH	
DOGA S.A. MAUREPAS MR. ANTY TEL 33-130664141 laurent.anty@doga.fr FAX 33-130664199		TEL 49-7021503201	
		OSG GMBH	
OSG France s.a.r.l. ROISSY sales@osg-france.com TEL 33-149901010 FAX 33-149901015		Göppingen TEL 49-716160640 info@osg-germany.de FAX 49-7161606444	
ITALY 6 distributors			
FEBAMETAL S.P.A. TORINO febametal@tin.it TEL 39-0117701412 FAX 39-0117701524		MAKINO ITALIA S.R.L. Cavenago di Brianza TEL 39-0295948290 FAX 39-0295948240	
		MMC ITALIA SRL MILANO info@mmc-italia.it TEL 39-029377031 FAX 39-0293589093	
MMC EMILIA ROMAGNA SRL MODENA MR. GIOVANNI FACCHINI TEL 39-0536946687 facchini@mmcemilia.it FAX 39-0536946695		OSG ITALIA SRL TORINO MR. VINCENZO RAGO TEL 39-0117705211 vincenzo.rago@osg-italia.it FAX 39-0117071402	
		TECNOR MACCHINE SPA MILANO info@tecnormacchine.it TEL 39-028242851 FAX 39-028255408	
NETHERLANDS 2 distributors		NORWAY 1 distributor	
Machining Innovations NL bv-Machinno MERSELO MR. MARK CAMPS TEL 32-93288811 info@machinno.com		AS NOR-SWISS OSLO MR. JAN EGE TEL 47-23241020 jan.ege@ege.no FAX 47-23241021	
POLAND 3 distributors			
Aura Frästechnik GMBH MR. KRZYSZTOF KOSLA TEL 48-666011225 k.kosla@aura-tools.de FAX 49-64659119429		MB Michał Rzepka OBORNIKI MR. BARTOSZ RZEPKA TEL 48-504647666 mb@mb-frezy.pl FAX 48-61622339	
		MMC HARDMETAL POLAND Sp. z o.o. WROCLAW MR. BOGUMIŁ ŁOZOWICKI TEL 48-655467284 blozowicki@mitsubishicarbide.com.pl FAX 48-655467283	
PORTUGAL 2 distributors		ROMANIA 1 distributor	
AMTOOLS MARINHA GRANDE geral@amtools.pt TEL 351-244560456 FAX 351-244560668		SIMPLEFER-COMERCIO DE FERRAMENTAS, LDA. MARINHA GRANDE MR. CARLOS ALVES TEL 351-244575350 carlos.alves@simplefer.pt FAX 351-244575359	
		MAZAROM IMPEX SRL BUCHAREST MR. ADRIAN TOTU TEL 40-212328001 adrian.totu@mazarom.ro FAX 40-212328002	
RUSSIA 2 distributors			
SodicoM-Center MOSCOW info@sodick.ru TEL 7-4957870970		SOLDREAM SPB SAINT-PETERSBURG soldream-spb@soldream-spb.com TEL 7-8123737456	
		STREULI TECHNOLOGIES AG BIRMENS DORF MR. STREULI TEL 41-17394070 w.streuli@streuli-techno.ch FAX 41-17394077	
SLOVAKIA 2 distributors		SWEDEN 1 distributor	
MAKINO S.R.O. BRATISLAVA TEL 421-249612100 FAX 421-249612400		OSG SCANDINAVIA A/S BROMÖLLA osg@osg-scandinavia.com TEL 46-40412255 FAX 46-40413255	
SLOVENIA 2 distributors			
Aura Frästechnik GMBH ŽALEC MR. SAMO KAČ TEL 386-37104080 info@kactrade.si		BTS COMPANY d.o.o. LJUBLJANA MR. BORIS POZAR TEL 386-15841400 boris.pozar@bts-company.si FAX 386-15249224	

SPAIN 3 distributors**DELFIN COMPONENTES S.L.****VIZCAYA**

MR. JON AZCUE TEL 34-944105544
 deflincomponentes@delfincomponentes.com FAX 34-944105544

JANA TOOLS SL**SONDIKA**

MR. JUAN JOSE JORDE TEL 34-944538224
 info@jana-tools.com FAX 34-944538225

UTILTALL S.A.**BARCELONA**

comercial@utiltall.es TEL 34-934984465
 FAX 34-933086993

TURKEY 3 distributors**FORM TEKNIK****ISTANBUL**

MR. ISMAIL CINAR TEL 90-2122973397
 info@form-teknik.com FAX 90-2122566215

TANDEM TAKIM TEZGAHLARI**ISTANBUL**

MR. TANKUT KOCAK TEL 90-2163131413
 tankut.kocak@tandem.com.tr FAX 90-2163131411

TEKNIKA HIRDAVAT SANAVI VE TICARET LTD. STL.**ISTANBUL**

MR. MEHMET AKKAYA TEL 90-2126742864
 info@teknikatools.com FAX 90-2126742863

UK 4 distributors**MATSUURA MACHINERY LTD****LEICESTERSHIRE**

MR. DAVID SPENCER TEL 44-1530511400
 dspencer@matsuura.co.uk FAX 44-1530511442

MMC HARDMETAL U.K. LTD**TAMWORTH**

MR. ADRIAN BARNACLE TEL 44-1827312312
 abarnacle@mitsubishicarbide.co.uk FAX 44-1827312314

OSG UK LTD.**ESSEX**

sales@osg-uk.com TEL 44-8453051066
 FAX 44-8453051067

KYOCERA SGS PRECISION TOOLS EUROPE LTD.**BERKSHIRE**

SalesEU@kyocera-sgstool.com TEL 44-1189795200
 FAX 44-1189795295

<North America>

U.S.A 8 distributors**MITSUBISHI MATERIALS USA CORP.****ILLINOIS**

TECHNICAL SERVICE TEL 1-800-486-2341
 marketingservices@mmus.com FAX 1-847-519-1732

ON TARGET TOOLING LLC**WISCONSIN**

MR. SCOTT SHIPPELL TEL 1-847-628-9942
 Scott@cimtekllc.com FAX 1-847-628-1987

OSG TAP & DIE, INC.**ILLINOIS**

MR. DAN VOLPE TEL 1-630-790-5141
 dan.volpe@osgtool.com FAX 1-630-800-837-3334

SINGLE SOURCE TECHNOLOGIES, INC.**MICHIGAN**

MR. RICK GRABAREK TEL 1-248-232-6268
 rgrabarek@singlesourcetech.com FAX 1-248-232-6261

WISCONSIN

MR. STEVE KLUG TEL 1-262-212-3825
 Steve.Klug@singlesourcetech.com FAX 1-262-574-7551

SOUTH CAROLINA

MS. CARA KELSO TEL 1-704-896-6000
 cara.kelso@singlesourcetech.com FAX 1-704-896-6002

ALABAMA

MR. BOB ASH TEL 1-256-301-0040
 bob.ash@singlesourcetech.com FAX 1-256-301-0059

PRECISION TOOLS SERVICE INC.**INDIANA**

MR. PAUL SCHNEPP TEL 1-812-342-1234
 pschnepp@ptservice.com FAX 1-812-342-1235

TECNARA TOOLING SYSTEMS, INC.**LOS ANGELES**

MR. DAVID TAKAHASHI TEL 1-562-941-2000
 la@tecnaratools.com FAX 1-562-946-0506

EAST COAST

MR. MATT GENOVESE TEL 1-203-912-8906
 la@tecnaratools.com FAX 1-562-946-0506

TOMITA USA INC.**OHIO**

1-614-873-6509
 FAX 1-614-873-6806

YAMAZEN INC. INC.**ILLINOIS**

MR. RYAN JACOBSON TEL 1-800-228-2969
 ryanjacobson@yamazen.com

LOS ANGELES

MR. MARK O'DONNELL TEL 1-800-882-8558
 markodonnell@yamazen.com

INDIANA

MR. BILL HAFLEY TEL 1-800-882-8558
 billhafley@yamazen.com

CONNECTICUT

MR. JON MORASUTTI TEL 1-800-882-8558
 jonmorasutti@yamazen.com

MICHIGAN

MR. RON HICKS TEL 1-800-882-8558
 ronhicks@yamazen.com

PHOENIX

MR. CLARENCE WAGNER TEL 1-800-882-8558
 clarencewagner@yamazen.com

CANADA 2 distributors**OSG CANADA LTD.****ONTARIO, Burlington**

MR. ROB ADKINS TEL 1-905-632-8032
 rob.adkins@osgcanada.com FAX 1-905-632-8466

SINGLE SOURCE TECHNOLOGIES, INC.**ONTARIO, Windsor**

MR. SHAWN LESPERANCE TEL 1-519-737-8999
 slesperance@singlesourcetech.com FAX 1-519-737-8939

MEXICO 5 distributors**AHNSA TOOLS s.a.****MONTERREY**

MR. HORACIO CAMPOS TEL 52-81-8126-1000
 hcampos@ahnsa.com FAX 52-81-8126-1001

MMC METAL DE MEXICO S.A. DE C.V**QUERETARO**

MR. GUILLERMO ORTIZ TEL 52-442 192 6800
 lortiz@mmcex.com FAX 52-442 221 6134

OSG /ROYCO, S.A. DE C.V.**MEXICO CITY**

MR. TOSHITAKA YOSHIZAKI TEL 52-55-51-19-3363
 toshi@osgroyco.com.mx FAX 52-55-51-19-3370

SINGLE SOURCE TECHNOLOGIES, de R.L.de C.V.**QUERETARO**

MR. MANUEL RUIZ TEL 52-442-1016000
 manuel.ruiz@singlesourcetech.com FAX 52-442-2531355

MONTERREY

MS. JUTZILL MANON TEL 52-442-101-6000
 Jutzill.Manon@singlesourcetech.com

YAMZEN MEXICANA SA DE CV**LEON**

MR. GERARDO PLASCENCIA TEL 52-477-3910280
 gerardo.perez@yamazen.com.mx FAX 52-477-3910278

<South America>

BRAZIL 2 distributors**OSG FERRAMENTAS DE PRECISAO LTDA.****SAN PAULO**

SALES DEPARTMENT TEL 55-11-6190-0900
 osgsp@nethall.com.br FAX 55-11-6190-0901

HeadlandMT Ltd**Auckland**

TEL 64-2152265

INNOVATE TECHNOLOGIES Brasil LTDA**SAN PAULO**

MR. LUCIANO CHIQUETTE TEL 55-19-3829-9280
 luciano.chiquette@innovatech.com.br

TOTAL CNC PRODUCTS**AUCKLAND**

MS. MARGARET WILLIAMS TEL 64-92745890
 admin@totalcnc.co.nz FAX 64-92745867

<Oceania>

New Zealand 2 distributors

<East Asia>

CHINA 23 distributors

AUTOFACT MACHINERY LTD. 亞動機械有限公司 DONGGUAN 東莞 MS. LILY GUAN 关星 TEL 86-769-81157228 lily@autofact.com.hk FAX 86-769-81157229		BBPC CO., LTD 上海阪商機床刀具有限公司 SHANGHAI 上海 MR. AMAYAMA 天山 TEL 86-21-6253-1219 osaka@bbpc.biz FAX 86-21-6256-3539		BEIJIN 北京 MS. CHANG YAOHUA 常耀华 TEL 86-10-6348-5150 osaka@bbpc.biz FAX 86-10-6348-5152	
DIJET INDUSTRIAL CO.,LTD. 黛傑工業株式會社 SHANGHAI 上海 MR. GAO YONGMING 高永明 TEL 86-21-5058-1698 dijetsh@yahoo.com.cn FAX 86-21-5058-1699		Dongguan Integrity Precision Machinery Co.,Ltd. 东莞市城晉精密機械有限公司 DONGGUAN 東莞 MR. YANG YABIN 楊亞兵 TEL 86-769-82288607 frank1_yang@126.com FAX 86-769-82288609		DONGGUAN YAJIYA Precision machinery Co., Ltd 東莞八字屋精密機械有限公司 DONGGUAN 東莞 MR. Jason lee 李忠信 TEL 86-769-8530-7420 yajiyasales@163.com FAX 86-769-8530-7470	
Fineness Corporation 匯穎國際貿易(上海)有限公司 SHANGHAI 上海 MR. STEVE HU 胡上干/MR. ROY LU 呂旺動 TEL 86-21-64282885 steve@fct-tools.com FAX 86-21-64391906		DONGGUAN 東莞 MR. ALAN CHEN 陳宏儒 TEL 86-769-82284785 alan@fct-tools.com FAX 86-769-82284797		DONGLI MACHINE CO.,LTD. 東立機械有限公司 DALIAN 大連 MS. ZHOU PING 周萍 TEL 86-411-87324719 zhou@dl-dongli.com.cn FAX 86-411-87324721	
TIANJIN 天津 MR. YANG JIAN 楊建 TEL 86-22-87395825 isabat_yang@fct-tools.com FAX 86-22-87395827		CHENGDU 成都 MR. JASON HUANG 黃琳琳 TEL 86-28-83112969 jasonhuang1121@163.com FAX 86-28-8311-2969		GALAXY PRECISION MACHINERY LTD 佳力精密機械有限公司 HONGKONG 香港 MR. KENNETH NG 吳志良 TEL 852-31505889 gp610@galaxy-mt.com FAX 852-23729093	
JECO PRECISION LTD. 捷高精機有限公司 HONGKONG 香港 MS. CATHY WONG 黃玉珍 TEL 852-2428-8328 cathy@jeco.hk FAX 852-2428-3683		SHENZHEN 深圳 MR. ERIC CHOW 周奔行 TEL 86-755-6116-2522 eric@jeco.hk FAX 86-755-6116-2533		JIANZE MACHINERY TECHNOLOGY CO.,LTD 上海建澤機械技術有限公司 SHANGHAI 上海 MR. XUE JIANMING 薛建明 TEL 86-21-51557657 xuejianming@jianze.net FAX 86-21-51557668	
KUNSHAN KUNQIAO TRADING CO.,LTD. 坤僑貿易有限公司 KUNSHAN 昆山 MR. CHOU TING SHENG 周廷升 TEL 86-512-57507151 kjcorp@ms56.hinet.net FAX 86-512-57507153		SHENZHEN 深圳 MR. GHENG-NAN, YEH 葉正勇 TEL 86-755-81786391~2 kj.com@msa.hinet.net FAX 86-755-8178-6670		MAKINO CHINA CO.,LTD. 牧野機床(中國)有限公司 KUNSHAN 昆山 MR. LIU HAORAN 劉浩然 TEL 86-512-5777-8000 info@makino.com.cn FAX 86-512-5777-9900	
PRO-TECHNIC MACHINERY LTD. 實力機械有限公司 HONG KONG 香港 MR. ALDO, S.K. CHEUNG 張四 TEL 852-2428-2727 aldocheung@protechnic.com.hk FAX 852-2480-4764		RSE (DALIAN) INTERNATIONAL TRADING CO LTD 美立吉(大連)國際貿易有限公司 DALIAN 大連 MR. LI GANG 李剛 TEL 86-411-8750-8552 01@chinarse.com FAX 86-411-8750-8553		OSG SHANGHAI 歐士機(上海)精密工具有限公司 SHANGHAI 上海 MS. JI MIN 嵇敏 TEL 86-21-5888-6600 jimin@chinaosg.com FAX 86-21-5888-3300	
SONDER TOOLS & MACHINERY(HK)LTD. 晨達(香港)有限公司 HONG KONG 香港 MR. JOHNNY NG 吳偉良 TEL 852-2-964-0233 johnnyng@sondertools.com FAX 852-2-964-0604		DONGGUAN 東莞 MR. JOHNNY NG 吳偉良 TEL 86-769-22699687 johnnyng@sondertools.com FAX 86-769-22699487		SHANGHAI HERLY INTERNATIONAL TRADING CO.,LTD. 上海賀立國際貿易有限公司 SHANGHAI 上海 MR. YOU JUNHA 由俊哈 TEL 86-21-3921-5609 import@herly.com FAX 86-21-3921-5606	
SHANGHAI 上海 MR. VICTOR LAU 劉曉炎 TEL 86-21-5109-6048 sonderbj@sonder.com.cn FAX 86-21-5111-3216		BEIJIN 北京 MS. LILIAN WANG ZHE 王浙 TEL 86-10-5862 2040 sonderbj@sonder.com.cn FAX 86-10-5862 2037		SHANGHAI REBAR CUTTING TOOLS CO., LTD 上海銳霸切削工具有限公司 SHANGHAI 上海 MR. CUI YANJUN 崔岩軍 TEL 86-21-5108-5980 steven_rb@126.com FAX 86-21-5763-2329	
SHENZHEN YINGFENGDA TRADING CO.,LTD 深圳市盈峰達貿易有限公司 SHENZHEN 深圳 MR. ZHANG CHENGZHONG 張承忠 TEL 86-755-25109822 Kelvin@yfd-group.com.cn FAX 86-755-23286077		TOJU MACHINE-ELECTRICITY CO.,LTD 上海東住機電科技有限公司 SHANGHAI 上海 MR. TIAN JUN 田軍 TEL 86-21-6413-8038 sh_toju@163.com FAX 86-21-5230-8016		SHANGHAI HERLY INTERNATIONAL TRADING CO.,LTD. 上海賀立國際貿易有限公司 SHANGHAI 上海 MR. YOU JUNHA 由俊哈 TEL 86-21-3921-5609 import@herly.com FAX 86-21-3921-5606	
YAMAZEN CORPORATION 山善(上海)貿易有限公司 SHANGHAI 上海 MR. KOZAWA 小澤 TEL 86-21-5445-2266 kozawa@yamazensh.com FAX 86-21-5445-2066		SHENZHEN 深圳 MR. YASUNO 安野 TEL 86-755-8280-5000 yasuno@yamazen.com.cn FAX 86-755-8280-5100		SICHENG Electromechanical Technology Co., Ltd 思誠機電科技有限公司 DONGGUAN 東莞 MR. Fly ZHONG 鐘飛泰 TEL 86-769-22186189 customer@ec-sourcing.com FAX 86-769-22186191	
DALIAN 大連 MR. ZHUANG 莊震 TEL 86-411-8762-6323 zhuangzhen@yamazensh.com FAX 86-411-8762-6332		CHONGQING 重慶 MR. HIROSE 廣瀨 TEL 86-23-8906-1951 hirose@yamazensh.com FAX 86-23-8906-1953		ZHEJIANG RI JIN CNC TOOLS CO., LTD. 浙江日進數控刀具有限公司 ZHEJIANG 浙江 MS. YE LI HONG 叶麗紅 TEL 86-576-84232178 cnrijin15@126.com FAX 86-576-84115612	
GUANGZHOU 廣州 MR. YAMASHITA 山下 TEL 86-20-8732-1601 yamashita@yamazen.com.cn FAX 86-20-8732-1232		TIANJIN 天津 MR. ZHUANG 莊震 TEL 86-22-2840-8710 zhuangzhen@yamazensh.com FAX 86-22-2840-8712			

TAIWAN 3 distributors

KUNJUNG CORPORATION 坤嶸企業有限公司 TAIPEI 台北 MR. CHUNG-WEI, HUANG 黃崇維 TEL 886-2-22902500 kjcorp@ms56.hinet.net FAX 886-2-22902515			KAOSHUNG 高雄 MR. TSUNG-LIEH, HO 何宗烈 TEL 886-7-7231101 chdhor@pchome.com.tw FAX 886-7-7236088			TAICHUNG 台中 MR. MING-CHIEH, YEN 顏明傑 TEL 886-4-27026477 kj.com@msa.hinet.net FAX 886-4-24520439		
CENTURY TRADING CORPORATION 世紀貿易股份有限公司 TAIPEI 台北 MR. YAN YUNGTA 顏永達 TEL 886-2-2298-8336 ytyan@centra.com.tw FAX 886-2-2298-8338			TAIHO TOOL MFG. CO.,LTD. 大寶精密工具股份有限公司 KAOSHUNG 高雄 yung-feng@mail.taihotool.co.tw TEL 886-7-621-6136 FAX 886-7-621-6140					

KOREA 9 distributors

KUK SUNG INTERNATIONAL CO.,LTD.
 국성인터내셔널주식회사
DAEGU 대구
 ■ MR. CHOI BYUNG HOON 최병훈 TEL 82-53-604-0521
 ✉ kuksung1@unitel.co.kr FAX 82-53-604-0525

DOO REE TRADING CO.,LTD.
 (유)두리무역
CHANGWON 창원
 ■ MR. J.K. CHO 조재관 TEL 82-55-286-5310
 ✉ dooree0909@naver.com FAX 82-55-284-5313

IGPNET CO.,LTD.
 주식회사 아이지피넷
SEOUL 서울
 ■ MR. KIM MOON KI 김문기 TEL 82-2-2026-5100
 ✉ mk-kim@igpnet.co.kr FAX 82-2-2026-5101

ITM KOREA
SUWON 수원
 ■ MR. LEE SANGKWANG 이상관 TEL 82-31-497-0917
 ✉ itmktorea2015@gmail.com FAX 82-50-4465-7218

KAMI CO.,LTD.
SEOUL 서울
 ■ MR. YOUNG L., KIM, PH. D. 김영림 TEL 82-2-6670-4114
 ✉ info@kami.biz FAX 82-2-6670-4110

MIRAE TECHNO
 미래테크노
GWANGMYEONG 광명
 ■ MR. PARK HO SUNG 박호성 TEL 82-31-479-5301
 ✉ miraetechno@hanmail.net FAX 82-31-479-5302

NS KOREA
 엔에스코리아
ANYANG 안양
 ■ MR. BAI JAMES 배성진 TEL 82-31-479-1207
 ✉ jamesbai@ns-korea.com FAX 82-31-479-1208

OSG KOREA CORPORATION
 한국OSG주식회사
DAEGU 대구
 ■ MR. JANG JUN YOUNG 장준영 TEL 82-53-589-2054
 ✉ jyjjang1@osg.co.kr FAX 82-53-583-5553

YAMAZEN (KOREA)LTD.
 (주)야마젠코리아
SEOUL 서울
 ■ MR. HORIKAWA MASAHIRO TEL 82-2-864-1755
 ✉ yamazen@yamazenkorea.co.kr FAX 82-2-864-1758

<South Asia>
INDIA 10 distributors

MAKINO INDIA PVT LTD.
BANGALORE
 ■ MR. B.V. SRIDHAR TEL 91-8067419500
 ✉ sridhar@makino.co.in FAX 91-8067419523
Delhi
 ■ MR. SHASHANK TOMAR TEL 91-1244652200
 ✉ shashankt@makino.co.in FAX 91-1244365217
Pune
 ✉ info@makino.co.in TEL 91-2138673600
 FAX 91-2138673623

ASSOCIATED ENGINEERING SERVICES CO.,LTD.
CHENNAI
 ■ MR. N MURALI TEL 91-4423821581
 ✉ murali@associatedengg.com FAX 91-4423821584

CUTTING EDGE TECHNOLOGIES
HYDERABAD
 ■ MR. PARDHA SARADHI TEL 91-9966133869
 ✉ cuttingedge.hyd@gmail.com

HSM CONSULTANTS INDIA Pvt. Ltd.
BANGALORE
 ■ MR. SREEDHAR SHENOY TEL 91-8023515220
 ✉ shenoy@hsmcil.com FAX 91-8023515220

MMC HARDMETAL INDIA PVT. LTD.
BANGALORE
 ✉ mmcindia@mmc.co.jp TEL 91-802308-3400

NETRA TECHNOLOGIES
AHMEDABAD
 ■ MR. CHIRAG PATEL TEL 91-9722323111
 ✉ info@netratechnologies.in

Orion Innotech Pvt. Limited
GURGAON
 ■ MR. VISHAL VERMA TEL 91-1244225210
 ✉ vishal@oriongroup.in FAX 91-1244225211

OSG (INDIA) PVT. LTD.
GURGAON
 TEL 91-1244009737
 FAX 91-1244207761

VALIANT INDIA
PUNE
 ■ MR. VIRENDRA MAYNALE TEL 91-9371672785
 ✉ sales@valiantindia.in

Yamazen Machinery & Tools India Pvt. Ltd.
Bangalore / Chennai / Gurgaon / Pune
 ✉ tooling@yamazen.in TEL 91-1244605900
 FAX 91-1244605921

INDONESIA 4 distributors

PT. JAVATEC TRIMITRA UTAMA
JAKARTA
 ■ MR. STEFANUS DIBYO TEL 62-21-458-77288
 ✉ tools@javatec.co.id FAX 62-21-458-77289

PT. JAVATEC TRIMITRA MACHINERY
JAKARTA
 ■ MR. JONATAN ARIF SANTOSO TEL 62-21-4584-9988
 ✉ jonatan@javatec-machinery.com FAX 62-21-4584-8899

YAMAZEN MACHINERY & TOOLS PHILIPPINES, INC.
LAGUNA
 ■ MR. SHIN ISHIDA TEL 63-49-543-1958
 ✉ s.ishida@yamazen.com.ph FAX 63-49-508-0893

PT. RUKUN SEJAHTERA TEKNIK
JAKARTA
 ■ MR. FRANKIE ANGGADHA TEL 62-21-628-1615
 ✉ marketing@rsttools.com FAX 62-21-626-5559

PT. YAMAZEN INDONESIA
JAKARTA
 ■ MR. KAZUHIKO UDA TEL 62-21-451-3345
 ✉ uda@yamazen.co.id FAX 62-21-451-3346

KAMOGAWA LAGUNA PHILIPPINES, INC.
LAGUNA
 ■ MR. TAKAHIRO FUNAKUBO TEL 63-49-576-4931
 ✉ t.funakubo@kamog.co.jp FAX 63-49-508-3199

SINGAPORE 5 distributors

A-TECH MARKETING PTE LTD
 ■ MR. IAN SOH TEL 65-6773-3148
 ✉ iansoh@a-tech.com.sg FAX 65-6234-4826

MAKINO ASIA PTE LTD.
 ■ MR. SAM SHUKOR TEL 65-6861-5722
 ✉ sam@makino.com.sg FAX 65-6861-1600

NOBELTECH PTE LTD
 ■ MR. ERIC CHAN TEL 65-6749-3636
 ✉ eric@nbel.com.sg FAX 65-6749-0303

OSG ASIA PTE LTD.
 ■ MR. YASUTAKA YONEDA TEL 65-6844-4350
 ✉ yasuyoneda@osgasia.com.sg FAX 65-6844-4351

YAMAZEN (SINGAPORE)PTE LTD.
 ■ MR. YOSHIYUKI ENDO TEL 65-6276-9488
 ✉ endo@yamazen.com.sg FAX 65-6276-9688

MALAYSIA 2 distributors

NEWLINE MACHINE TOOL SDN.BHD.
KUALA LUMPUR
 ■ MR. JEFFREY PW CHOON TEL 60-3-8961-1973
 ✉ jeff@newlinemachine.com FAX 60-3-8961-1971

YAMAZEN (MALAYSIA)SDN.BHD.
KUALA LUMPUR
 ■ MR. AKIRA KATO TEL 60-3-5569-5099
 ✉ kato@yamazen.com.my FAX 60-3-5569-5011
PENANG
 ■ MR. CHENG TEL 60-4-399-4021
 ✉ mecheng@yamazen.com.my FAX 60-4-399-3025

THAILAND 4 distributors

FACTORY MAX CO.,LTD.
BANGKOK
 ■ MR. S. TANGTARATORN TEL 66-2-759-9100
 ✉ surapong@factorymax.co.th FAX 66-2-759-9009

MAKINO (THAILAND) CO.,LTD.
BANGKOK
 ■ MR. JUNYA YOSHIMURA TEL 66-2-971-5750
 ✉ junya.yoshimura@makino.co.th FAX 66-2-971-5751

PRECISION TOOLS SERVICE (THAILAND) CO.,LTD.
BANGKOK
 ■ MR. YOSHIKI KATO TEL 66-2-308-2470
 ✉ sales@ptsthai.com FAX 66-2-308-2471

YAMAZEN (THAILAND) CO.,LTD.
BANGKOK
 ■ MR. TOMOKI YAMADA TEL 66-2-374-5522
 ✉ yamada@yamazen.co.th FAX 66-2-374-3192

VIETNAM 3 distributors

KAMOGAWA VIETNAM CO.,LTD
Hanoi
 ■ MR. TOMOHIRO YAMAMOTO TEL 84-24-378-550-22/23
 ✉ yamamoto@kamog.co.jp FAX 84-24-378-550-23

Ho Chi Minh
 ■ MR. SHINJI KUSUMOTO TEL 84-28-391-054/77/78/79
 ✉ kusumoto@kamog.co.jp FAX 84-28-3910-5480

T&B TECHNICAL SERVICES AND TRADING CO.,LTD
Hanoi
 ■ MR. LUU QUANG THOA TEL 84-24-6659-5103
 ✉ thoa-luu@tbvn.com.vn

YAMAZEN VIETNAM CO.,LTD
Hanoi
 ■ MR. DAISUKE TOCHIGI TEL 84-4-3728 6292
 ✉ tochigi@yamazenvn.com FAX 84-4-3766-4137

Ho Chi Minh
 ■ MR. TAKEHITO NAKAJIMA TEL 84-8-54179 229
 ✉ tn790717@yamazenvn.com FAX 84-8-3820-2784



高精度保証

GUARANTEED ACCURACY

超精密級 5μm

標準級 10μm

標準級

標準

MST corp.

EMERGENCY EXIT

SHRINK-FIT HOLDER

MST

MONO-CURVE

MST corp.

MST

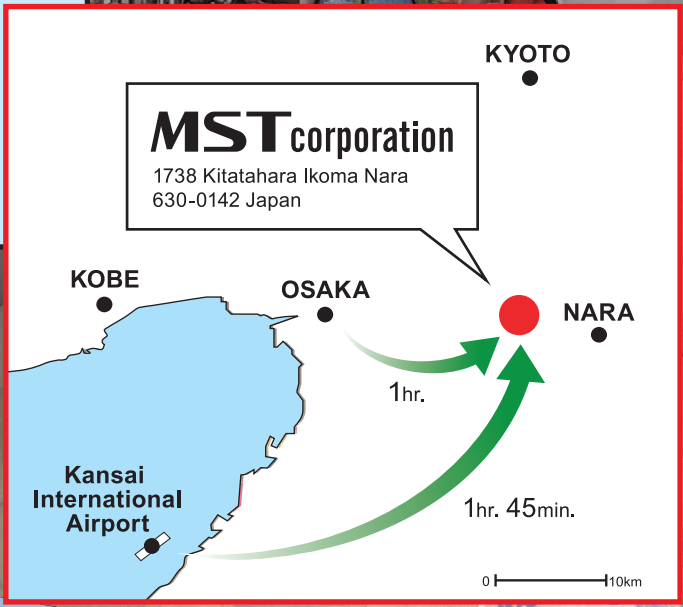



HEAD OFFICE & FACTORY

1738 Kita-tahara, Ikoma,
Nara 630-0142 Japan
Tel : +81 743 78 1931
Fax : +81 743 78 3854
✉ : info@mst-corp.co.jp

MSTcorporation
<http://www.mst-corp.co.jp>